















CARE AND MAINTENANCE

Wipe clean with a soft, dry cloth. Test the cleaning method on a hidden area before using them over the entire area.

NOTICE

- * Please make sure that you have all parts indicated before you begin assembly of this item.
- * This item should be assembled on a soft surface to prevent scratching the finished product during assembly.

Part List and Hardware List

PIECE	DESCRIPTION	PICTURE	QUANTITY
A	Headboard		1x
B	Leg(L)		1x
	Leg(R)		1x
C	Connect Bar		1x
D	Metal Plate	 3.0*20*75	2x
H1	Allen Bolt	 1/4"*2-1/4"	2x
H2	Allen Bolt	 5/16"*2"	4x
H3	Allen Bolt	 1/4"*5/8"	8x
H4	Flat Washer	 $\phi 23*1.8$	8x
H5	Spring Washer	 5/16"	4x
H6	Nut	 5/16"	4x
H7	Wrench	 M12	1x
H8	Allen Key L	 M5	1x
H9	Allen Key S	 M4	1x

Product Dimensions: 53-5/8"W*1-1/4"D*59-3/4"H

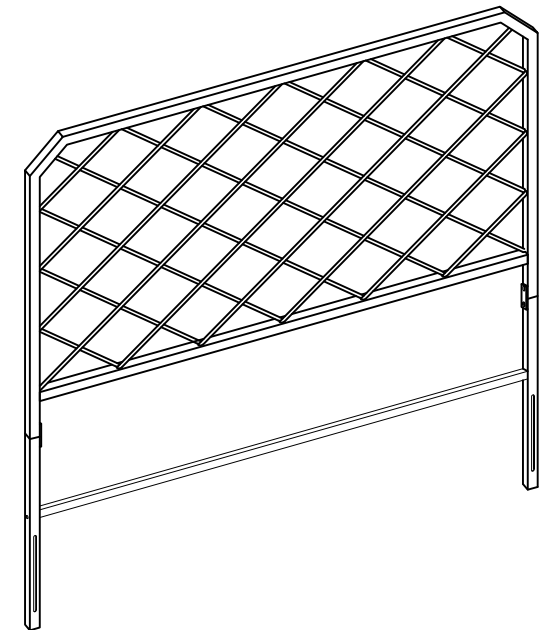

The hardware that is needed to connect the headboard to the bed frame is included. Please note that our headboard legs are compatible to most standard bedframes. Our headboards **DO NOT** include a mounting bracket.

Example of Mounting Bracket'



PREPARATION

Before beginning assembly of product, make sure all parts are present. Compare parts with package contents list and hardware contents list. If any part is missing or damaged, do not attempt to assemble the product.

Estimated Assembly Time: 10 minutes.

Tools Required for Assembly (included): Allen Key/Wrench

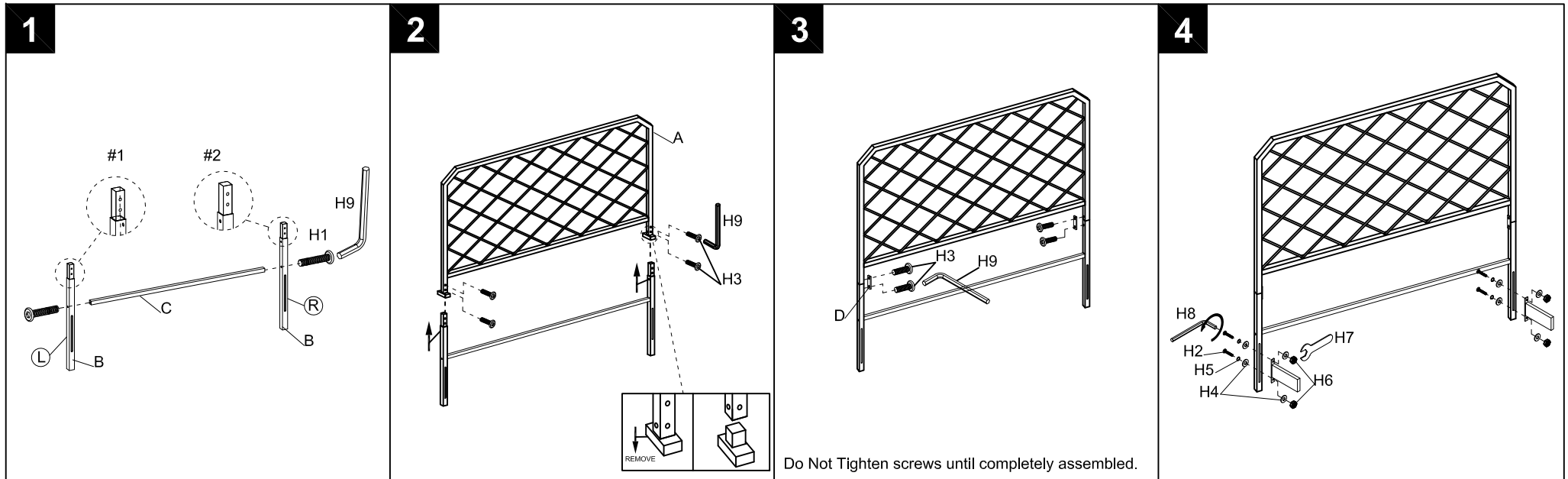

Step 1

Attach Leg (B) left/right with the Connect Bar (C). Use Allen Key (H9) to lock 2 * Allen Bolts (H1) into the Connect Bar. NOTE the holes of both legs should be facing forward as picture #1 & #2.

Step 2

Remove the wood plug from both end-post of Headboard. Then attach Headboard (A) with assembled legs. Use Allen Key (H9) to lock the 4 * Allen Bolts (H3).

Step 3

Use Allen Key (H9) to lock Metal Plate (D) into the assembled headboard/legs with 4 Allen Bolts (H3).

Step 4

To assemble Side Rail (not provided) with Headboard ==> Use Allen key (H8) to lock Allen Bolts (H2) with the Spring Washer (H5) & Flat Washer (H4). Use Wrench (H7) to lock into assembled headboard/legs with Flat Washer (H4) and Nut (H6) from the other side. Assembly is completed.















CARE AND MAINTENANCE

Wipe clean with a soft, dry cloth. Test the cleaning method on a hidden area before using them over the entire area.

NOTICE

- * Please make sure that you have all parts indicated before you begin assembly of this item.
- * This item should be assembled on a soft surface to prevent scratching the finished product during assembly.

Part List and Hardware List

PIECE	DESCRIPTION	PICTURE	QUANTITY
A	Headboard		1x
B	Leg(L)		1x
	Leg(R)		1x
C	Connect Bar		1x
D	Metal Plate	 3.0*20*75	2x
H1	Allen Bolt	 1/4"*2-1/4"	2x
H2	Allen Bolt	 5/16"*2"	4x
H3	Allen Bolt	 1/4"*5/8"	8x
H4	Flat Washer	 $\phi 23*1.8$	8x
H5	Spring Washer	 5/16"	4x
H6	Nut	 5/16"	4x
H7	Wrench	 M12	1x
H8	Allen Key L	 M5	1x
H9	Allen Key S	 M4	1x

Product Dimensions: 60-5/8"W*1-1/4"D*59-3/4"H

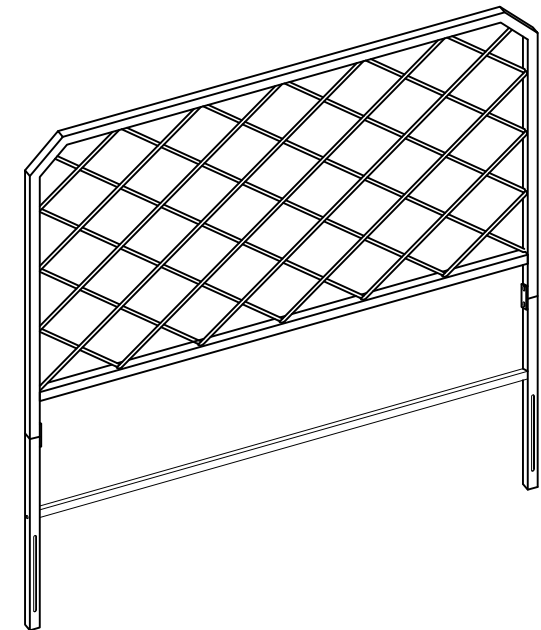

The hardware that is needed to connect the headboard to the bed frame is included. Please note that our headboard legs are compatible to most standard bedframes. Our headboards **DO NOT** include a mounting bracket.

Example of Mounting Bracket'



PREPARATION

Before beginning assembly of product, make sure all parts are present. Compare parts with package contents list and hardware contents list. If any part is missing or damaged, do not attempt to assemble the product.

Estimated Assembly Time: 10 minutes.

Tools Required for Assembly (included): Allen Key/Wrench

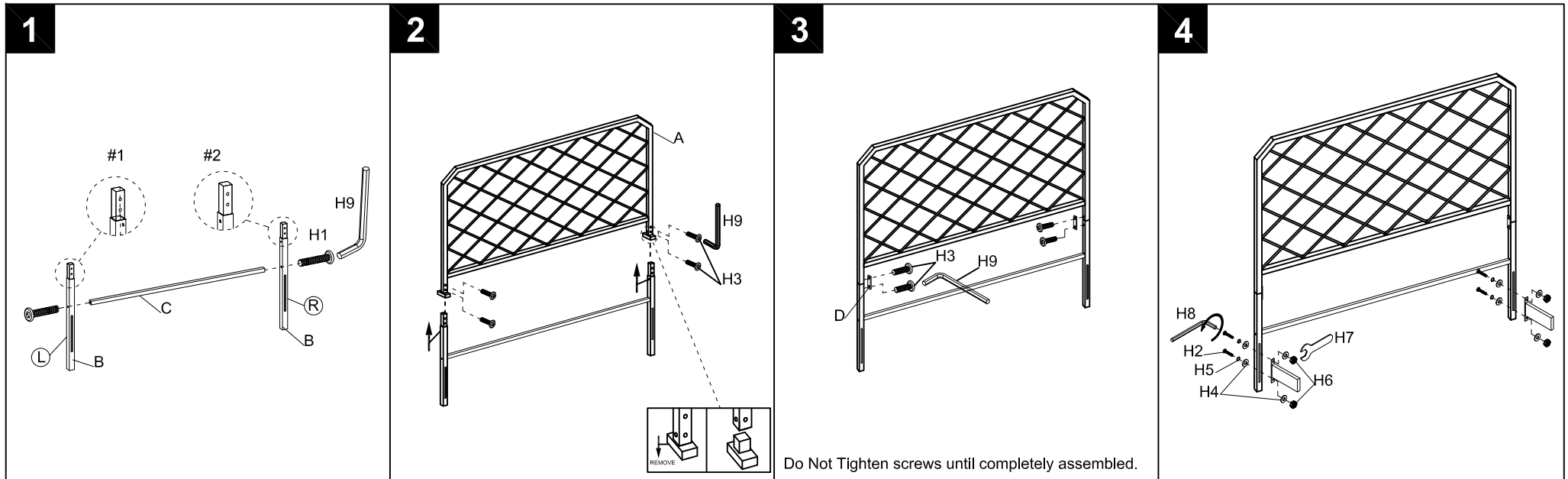

Step 1

Attach Leg (B) left/right with the Connect Bar (C). Use Allen Key (H9) to lock 2 * Allen Bolts (H1) into the Connect Bar. NOTE the holes of both legs should be facing forward as picture #1 & #2.

Step 2

Remove the wood plug from both end-post of Headboard. Then attach Headboard (A) with assembled legs. Use Allen Key (H9) to lock the 4 * Allen Bolts (H3).

Step 3

Use Allen Key (H9) to lock Metal Plate (D) into the assembled headboard/legs with 4 Allen Bolts (H3).

Step 4

To assemble Side Rail (not provided) with Headboard ==> Use Allen key (H8) to lock Allen Bolts (H2) with the Spring Washer (H5) & Flat Washer (H4). Use Wrench (H7) to lock into assembled headboard/legs with Flat Washer (H4) and Nut (H6) from the other side. Assembly is completed.