

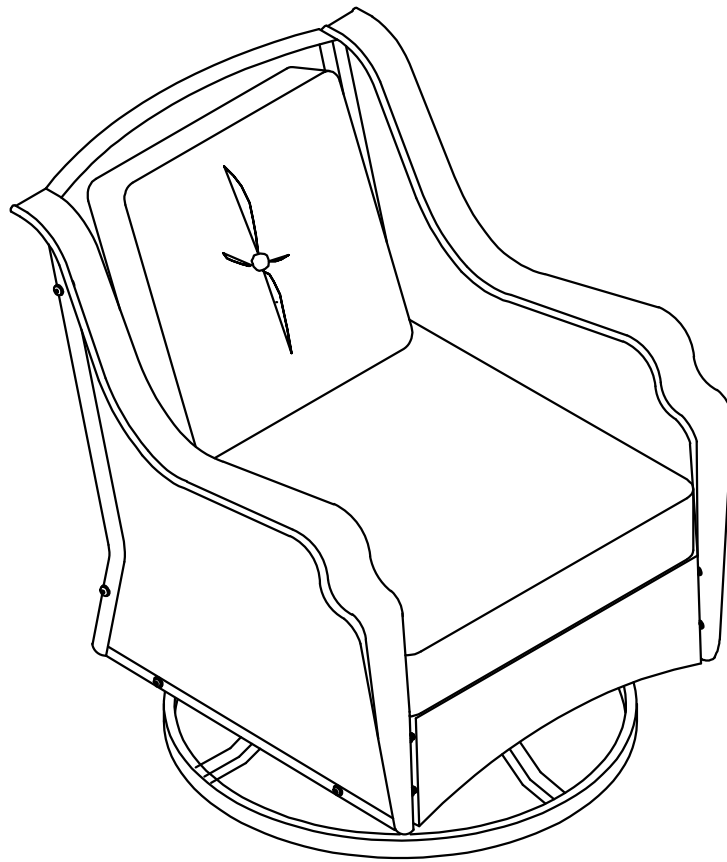













Assembly Instructions

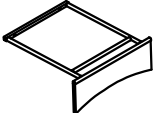

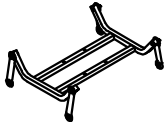
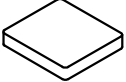
***Don't fully tighten all the bolts till the very end!**

PRE-ASSEMBLY PREPARATION:

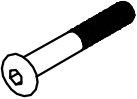
- Please read through the instructions before beginning assembly.
- Clear out the space for assembly and lay out all of the parts based on the Parts List, extra room will allow you to easily determine if all the pieces are present.
- Keep small parts and pieces away from children until fully assembled.

Part no.	Part	QTY	Image	Part no.	Part	QTY	Image
A1	Left arm	1		I	Nut	8	
A2	Right arm	1		J	Allen Wrench	1	
B	Back	1		K	Wrench	1	
C	Seat	1		L	Spring Washer	4	
D	U-Shape Fitting	1		M	Seat Cushion	1	
E	Base	1		N	Back Cushion	1	
F	Bolt (M6*15mm)	4					
G	Bolt (M6*35mm)	14					
H	Washer	18					

Step 1: Attach left arm (A1) to back panel (B) with 2 pcs bolts (F) and 2pcs washers (H).using Allen wrench J. Note: Don't fully tighten the bolts.

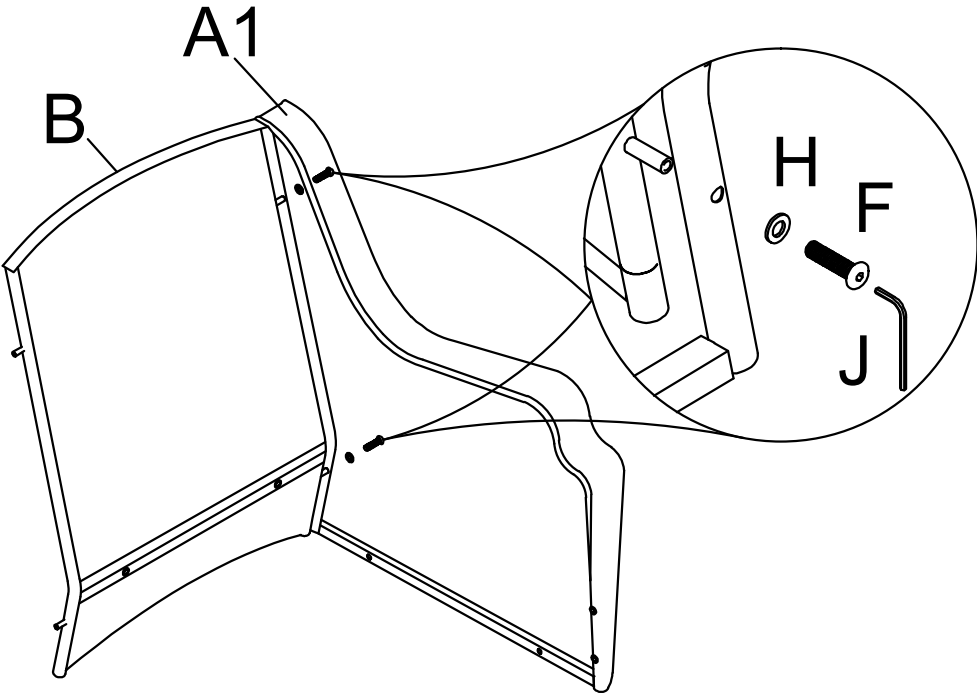

Step 2: Attach right arm (A2) to back panel (B) with 2 pcs bolts (F) and 2pcs washers (H).using Allen wrench J. Note: Don't fully tighten the bolts .

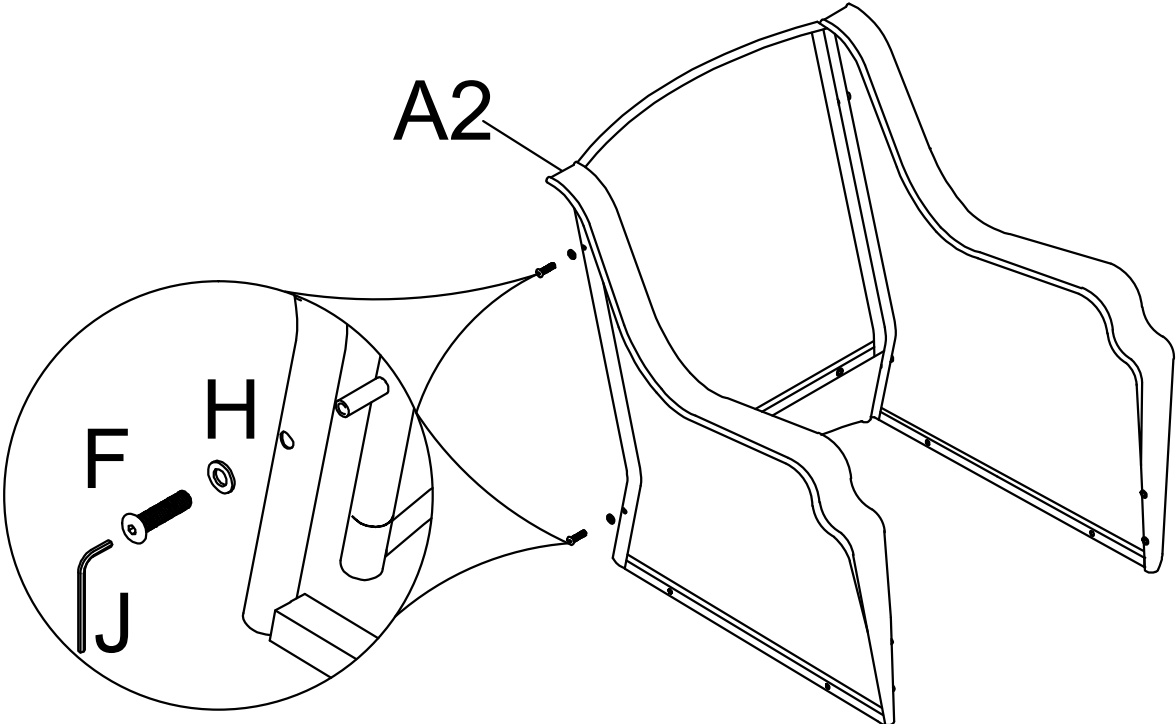

Step 3: Attach seat C to arms A1&A2 with 4pcs bolts G and 4pcs washers H, using Allen wrench J. Note: Don't fully tighten the bolts.

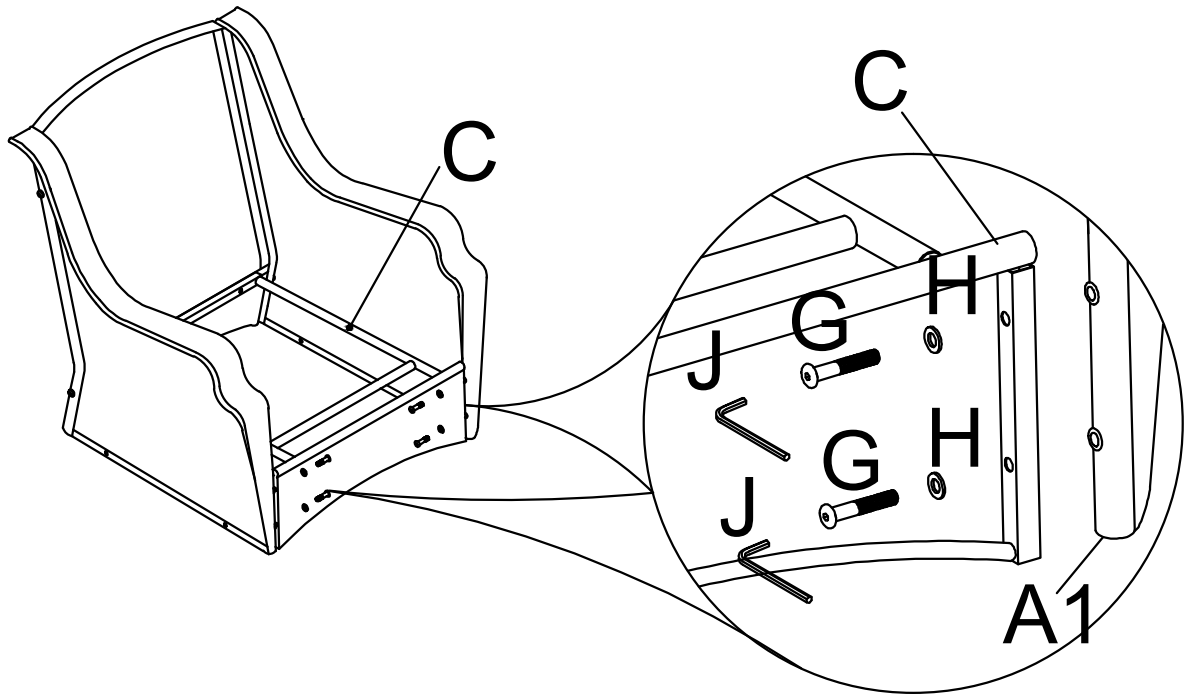

Step 4: Attach seat C to back B with 2pcs bolts G and 2pcs washers H, using Allen wrench G. Note: Don't fully tighten the bolts.

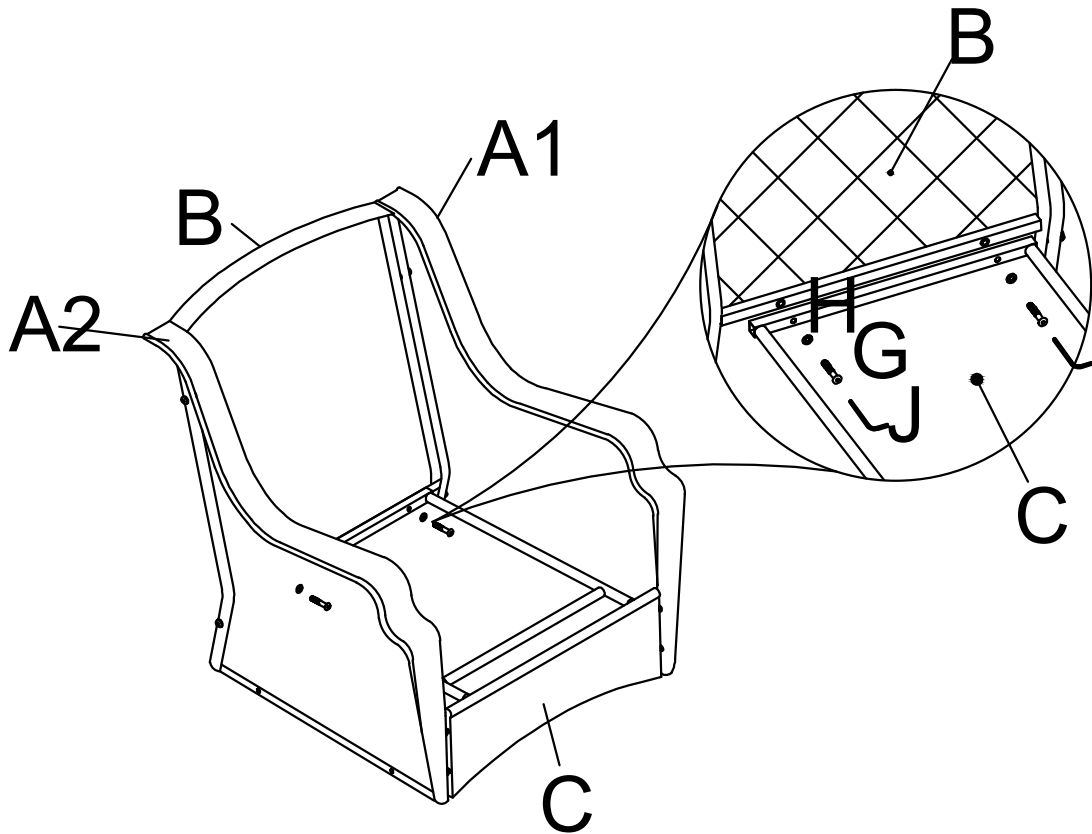

Step 5: Attach U-Shape Fitting D to arms with 4pcs bolts G and 4pcs nuts I, using Allen wrench J and Wrench K. Note: Don't fully tighten the bolts.

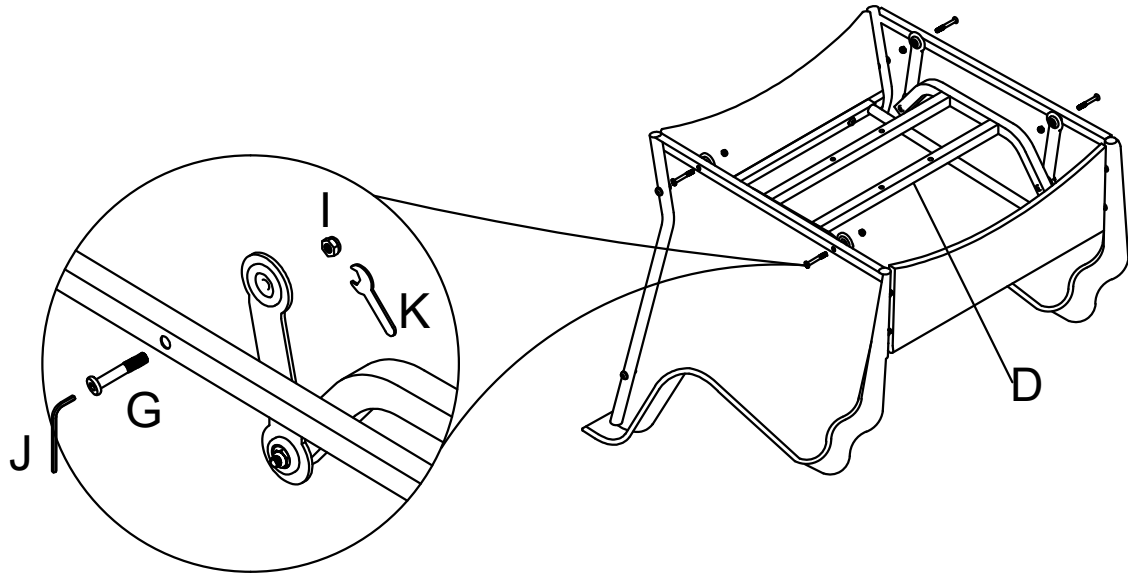

Step 6: Attach the base E to U-Shape Fitting D with 4pcs bolts G, 8pcs washers H, 4pcs spring washers L and 4pcs nuts I, using Allen wrench J and Wrench K. Note: Please fully tighten all the bolts.

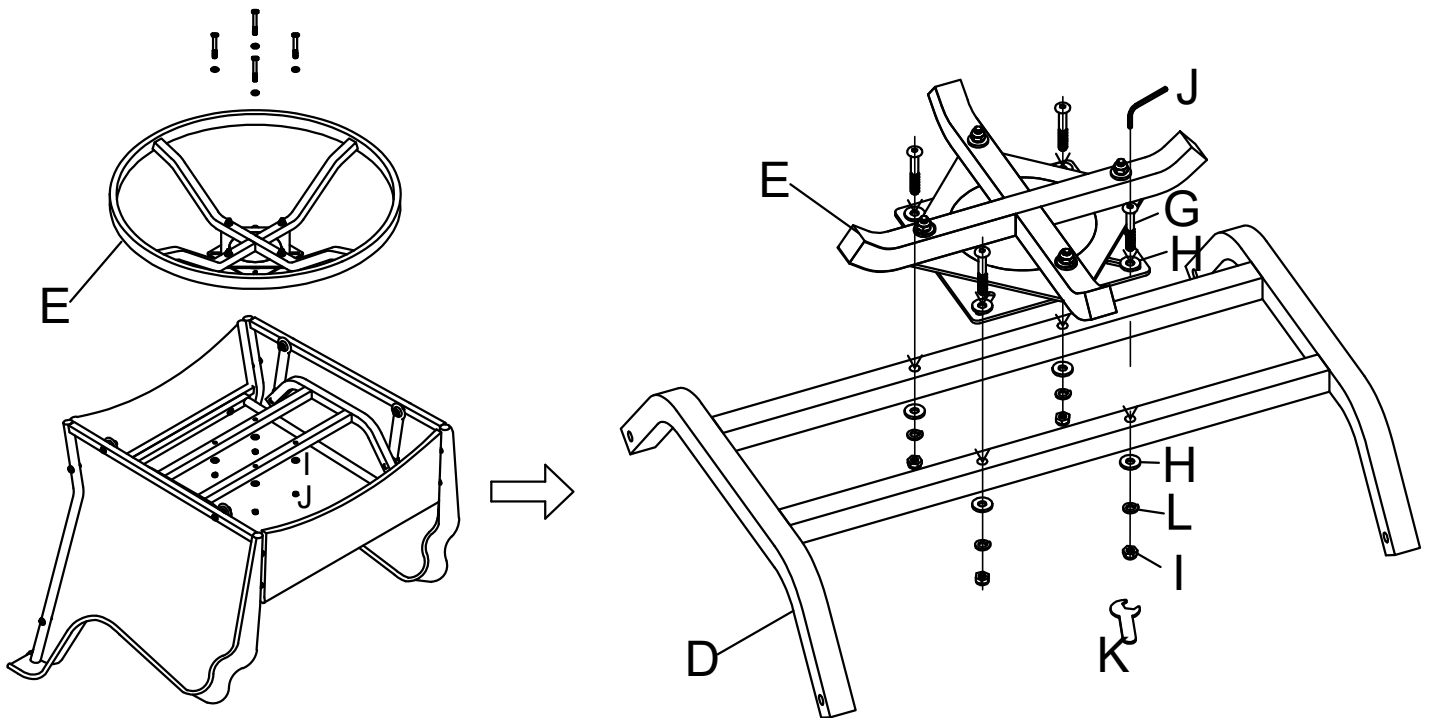

Step 7: Put seat cushion M and back cushion N onto the seat. Assembly is now complete and the product is ready for use

