

ASSEMBLY INSTRUCTIONS

INSTRUCTIONS DE MONTAGE

FULL/QUEEN BUNKBED

LIT SUPERPOSÉ COMPLET/QUEEN

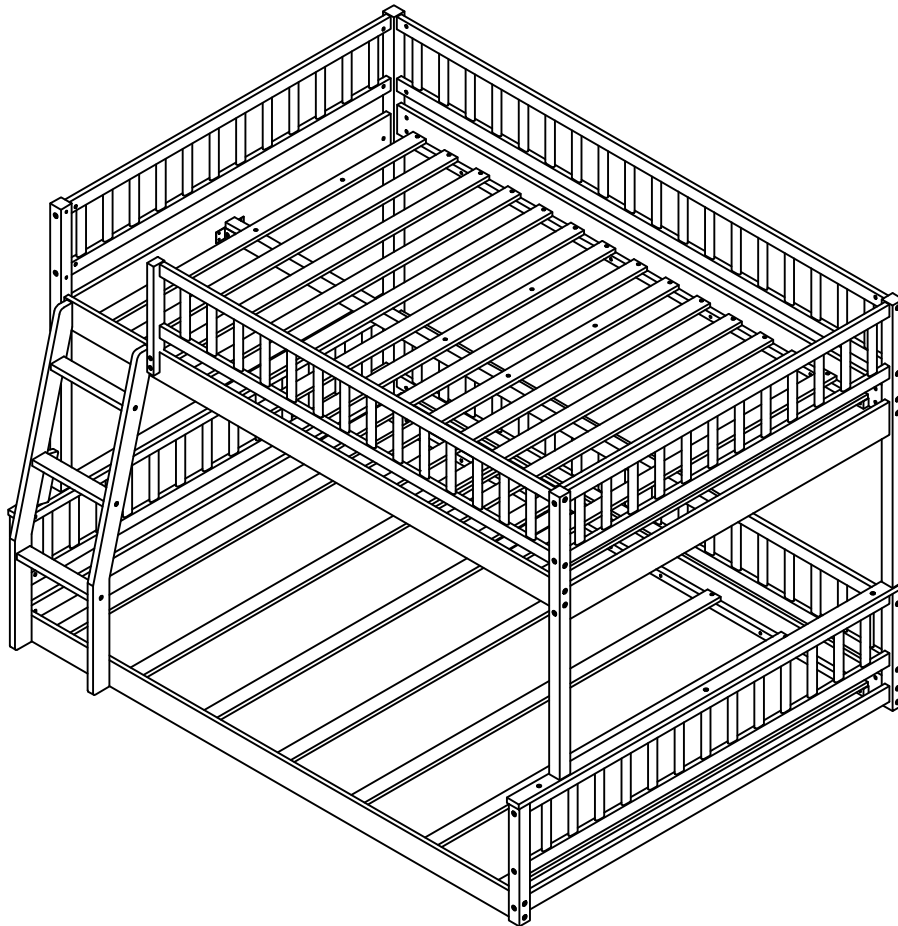

WF321045/WF321046

SAFETY WARNINGS AND GENERAL NOTES:

Follow the information on the warnings on the bunk bed end structure and on the carton. Do not remove the warning label from the bed. Always use the recommended size mattress on mattress support, or both, to help prevent the likelihood of entrapment or falls.

The top surface of the mattress must be at least 5*inch (127mm) below the upper edge of the guardrail.

Do not allow children under 6 years of age to use the upper bunk.

Periodically check and ensure the guardrail, ladder and other components are in their proper position, free from damage, and all connectors are tight.

Do not allow horseplay on or under beds.

Always prohibit jumping on the bed.

Prohibit more than one person on upper bunk.

Always use the ladder for entering and leaving the upper bunk.

Do not use substitute parts. Contact the manufacturer or dealer for replacement parts.

Use of a night-light may provide added safety precaution for a child using the upper bunk.

Always use guardrails on both long sides of the upper bunk.

If the bunk bed will be placed next to a wall, the guardrail that runs the full length of the bed should be placed against the wall to prevent entrapment between the bed and the wall.

The use of water or sleep flotation mattresses is prohibited.

STRANGULATION HAZARD-Never attach or hang items to any part of the bunk bed that are not designed for use with the bed.

Keep these instructions for future reference.

We recommend assembling your bunk bed on the shipping carton to protect your floor or carpet.

Be certain all staples are out of the box before beginning assembly on the shipping carton.

THIS BED IS DESIGNED TO USE A FULL XL MATTRESSES 54" WIDE X 79"-80" LONG WITH THE TOTAL THICKNESS NOT EXCEEDING 6" FOR UPPER BUNK, FOR THE LOWER QUEEN-SIZE SHOULD BE 60" WIDE X 80" LONG, WIDE WITH 8" THICKNESS.

SURFACE OF MATTRESS MUST BE AT LEAST 5" (127MM) BELOW THE UPPER EDGE OF GUARDRAILS.

Replacement Parts:

Replacement Parts, including additional guardrails, may be obtained from any of our (NOBLE HOUSE HOME FURNISHINGS CANADA INC. 3-8030 ESQUESING LINE MILTON, Ontario L9T 6W3) dealers.

AVERTISSEMENTS DE SÉCURITÉ ET REMARQUES GÉNÉRALES :

Suivez les informations sur les avertissements figurant sur la structure d'extrémité du lit superposé et sur le carton. Ne retirez pas l'étiquette d'avertissement du lit. Utilisez toujours le matelas de taille recommandée sur le support de matelas, ou les deux, pour éviter tout risque de coincement ou de chute.

La surface supérieure du matelas doit être à au moins 5*poûces (127 mm) sous le bord supérieur du garde-corps.

Ne laissez pas les enfants de moins de 6 ans utiliser le lit supérieur.

Vérifiez périodiquement et assurez-vous que le garde-corps, l'échelle et les autres composants sont dans leur bonne position, exempts de dommages et que tous les connecteurs sont bien serrés.

Ne permettez pas les chahuts sur ou sous les lits.

Interdisez toujours de sauter sur le lit.

Interdire plus d'une personne sur la couchette supérieure.

Utilisez toujours l'échelle pour entrer et sortir du lit supérieur.

N'utilisez pas de pièces de rechange. Contactez le fabricant ou le revendeur pour obtenir des pièces de rechange.

L'utilisation d'une veilleuse peut fournir une précaution supplémentaire en matière de sécurité pour un enfant utilisant le lit supérieur.

Utilisez toujours des garde-corps sur les deux côtés longs du lit supérieur.

Si le lit superposé doit être placé à côté d'un mur, le garde-corps qui s'étend sur toute la longueur du lit doit être placé contre le mur pour éviter tout coincement entre le lit et le mur.

L'utilisation de matelas flottants à eau ou de sommeil est interdite.

RISQUE D'ÉTRANGULATION - N'attachez ou ne suspendez jamais d'objets à une partie du lit superposé qui ne sont pas conçus pour être utilisés avec le lit.

Conservez ces instructions pour référence future.

Nous vous recommandons d'assembler votre lit superposé sur le carton d'expédition pour protéger votre sol ou votre tapis.

Assurez-vous que toutes les agrafes sont sorties de la boîte avant de commencer l'assemblage sur le carton d'expédition.

CE LIT EST CONÇU POUR UTILISER UN MATELAS COMPLET XL DE 54" DE LARGE X 79" - 80" DE LONG AVEC L'ÉPAISSEUR TOTALE NE DÉPASSANT PAS 6" POUR LE COUCHE SUPÉRIEUR, POUR LE QUEEN INFÉRIEUR, LA TAILLE INFÉRIEURE DEVRAIT ÊTRE 60" DE LARGE X 80" DE LONG, DE LARGE AVEC 8" D'ÉPAISSEUR.

LA SURFACE DU MATELAS DOIT ÊTRE AU MOINS 5" (127 MM) EN DESSOUS DU BORD SUPÉRIEUR DES GARDE-CORPS.

Pièces de rechange :

Les pièces de rechange, y compris les garde-corps supplémentaires, peuvent être obtenues auprès de l'un de nos revendeurs (NOBLE HOUSE HOME FURNISHINGS CANADA INC. 3-8030 ESQUESING LINE MILTON, Ontario L9T 6W3).





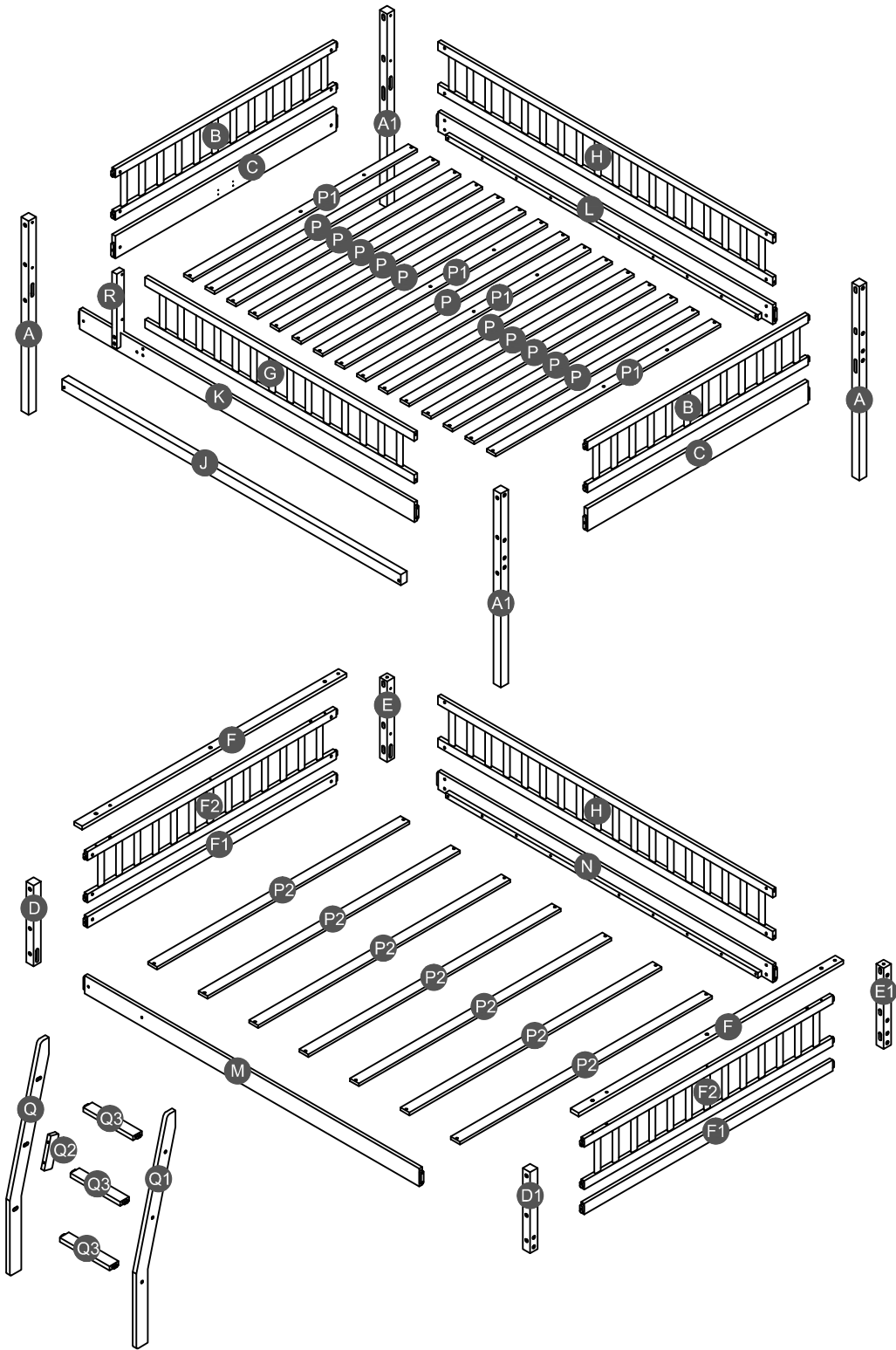

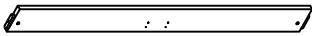

Detail View

Vue Détaillée

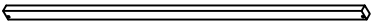

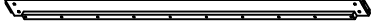





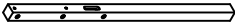
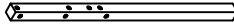
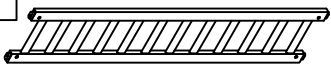
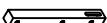
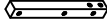
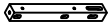
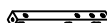

Part list & Hardware list (Box 1 - WF321045)

Liste des pièces & liste du matériel (Boîte 1 - WF321045)

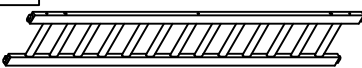
<p>C</p>  <p>Upper horizontal bar HB/FB - 2pcs Barre horizontale supérieur HB/FB</p>	<p>G</p>  <p>Short guard rail (Front) - 1pc Garde-corps court (avant)</p>	<p>H</p>  <p>Long guard rail (Back) - 2pcs Garde-corps long (Arrière)</p>
<p>J</p>  <p>Lower support slat - 1pc Latte de support inférieure</p>	<p>K</p>  <p>Upper side rail (Front) - 1pc Rail latéral supérieur (Avant)</p>	<p>L</p>  <p>Upper side rail (Back) - 1pc Rail latéral supérieur (arrière)</p>
<p>M</p>  <p>Lower side rail (Front) - 1pc Rail latéral inférieure (Avant)</p>	<p>N</p>  <p>Lower side rail (Back) - 1pc Rail latéral inférieure (arrière)</p>	<p>P2</p>  <p>Lower Slat - 7pcs Latte inférieure</p>

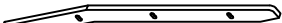









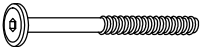

Part list (Box 2 - WF321046)

Liste des pièces (Boîte 2 - WF321046)

<p>A</p>  <p>Upper Leg (Left front /Right back) - 2pcs Supérieur pied (avant gauche/arrière droit)</p>	<p>A1</p>  <p>Upper Leg (Left back /Right front) - 2pcs Supérieur pied (Arrière gauche/Avant droit)</p>	<p>B</p>  <p>Upper Frame HB/FB - 2pcs Cadre supérieur HB/FB</p>
<p>D</p>  <p>Lower Leg (Left front) - 1pc inférieure pied (Avant gauche)</p>	<p>D1</p>  <p>Lower Leg (Right front) - 1pc inférieure pied (avant droit)</p>	<p>E</p>  <p>Lower Leg (Left back) - 1pc inférieure pied (Arrière gauche)</p>
<p>E1</p>  <p>Lower Leg (Right back) - 1pc inférieure pied (Arrière droit)</p>	<p>F</p>  <p>Cap for upper HB/FB - 2pcs Capuchon pour HB/FB supérieur</p>	<p>F1</p>  <p>Lower horizontal bar HB/FB - 2pcs Barre horizontale inférieure HB/FB</p>
<p>F2</p>  <p>Lower Frame HB/FB - 2pcs Cadre inférieur HB/FB</p>	<p>P</p>  <p>Upper Slat - 11pcs Latte supérieure</p>	<p>P1</p>  <p>Upper Slat - 4pcs Latte supérieure</p>
<p>Q</p>  <p>Left side ladder - 1pc Échelle côté gauche</p>	<p>Q1</p>  <p>Right side ladder - 1pc Échelle côté droit</p>	<p>Q2</p>  <p>Support ladder - 1pc Échelle de soutien</p>
<p>Q3</p>  <p>Step ladder - 3pcs Escabeau</p>	<p>R</p>  <p>Support guard rail (Left) - 1pc Support garde-corps (gauche)</p>	

Hardware List (Box 1 - WF321045)

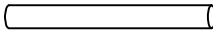
Liste du matériel (Boîte 1 - WF321045)

1  (Ø15)1/4"*100mm Hex-Head bolts (26pcs) Boulons à tête hexagonale	2  (Ø15)1/4"*80mm Hex-Head bolts (26pcs) Boulons à tête hexagonale	3  (Ø12)1/4"*60mm Hex-Head bolts (8pcs) Boulons à tête hexagonale
4  (Ø12)1/4"*40mm Hex-Head bolts (6pcs) Boulons à tête hexagonale	5  (Ø12)1/4"*35mm Hex-Head bolts (2pcs) Boulons à tête hexagonale	6  1/4"*15 (9.5mm) Horizontal-Hole bolts(58pcs) Boulons à trou horizontal
7  (Ø12)1/4"*40mm Hex-Head bolts (6pcs) Boulons à tête hexagonale	8  Ø4*30mm Wood screws (48pcs) Vis	9  Ø3.5*15mm Wood screws (8pcs) Vis
10  (Ø13)1/4"*14mm Connect bolt (2pcs) Connecter le boulon	11  116*40*27mm Metal bracket (2pcs) Support métallique	12  Ø9*90mm Connecting bar (4pcs) Barre de connexion
13  (1/4")4.5*58mm Allen key (2pcs) Clé Allen		

ASSEMBLY TOOLS REQUIRED (NOT INCLUDED)

OUTILS D'ASSEMBLAGE REQUIS (NON INCLUS)

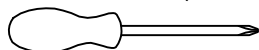

(Phillip head screwdriver)





PLEASE BE CAREFUL DO NOT DAMAGE THE HOLE POSITION WHEN YOU USE POWER TOOLS !

NE PAS UTILISEZ DES OUTILS ÉLECTRIQUES POUR ASSEMBLER CE PRODUIT !

STEP 1:

ÉTAPE

2		6	
12PCS		12PCS	

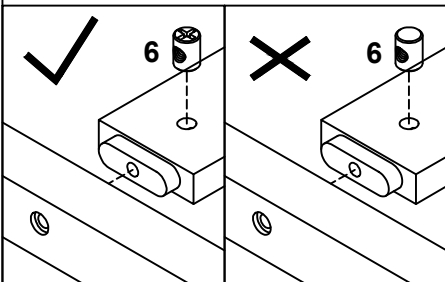
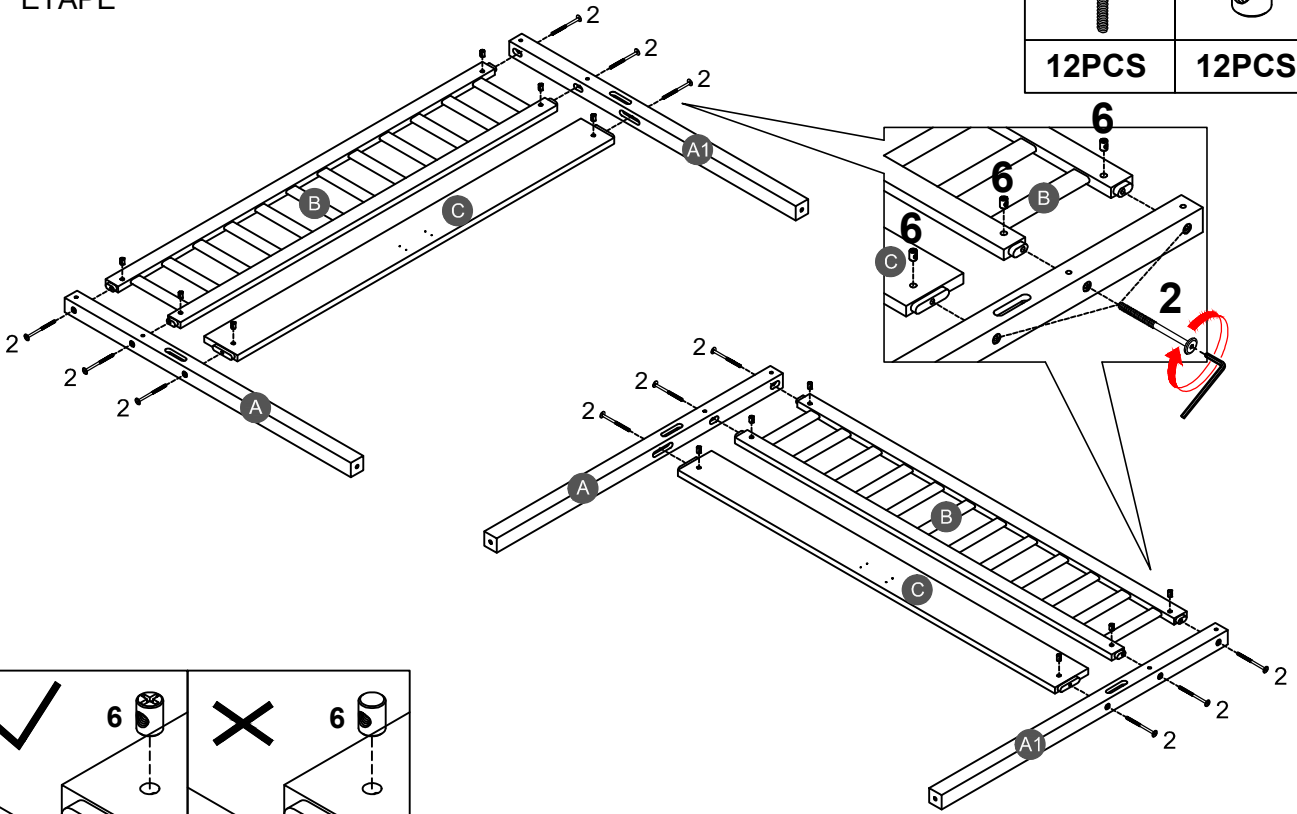



Note: Part 6 will face up with the "x" mark on it, otherwise it cannot be tightened

Remarque: La pièce 6 sera face vers le haut avec la marque "x", sinon elle ne peut pas être serrée.

STEP 2:

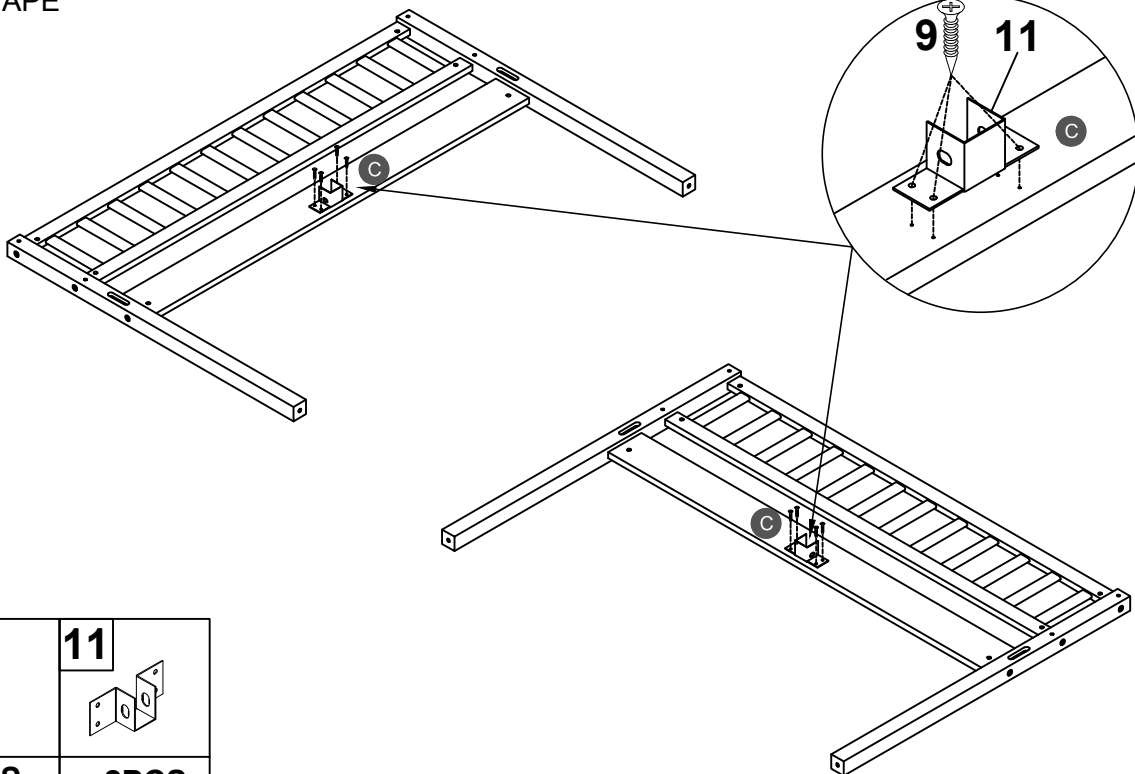

ÉTAPE



9		11	
8PCS		2PCS	

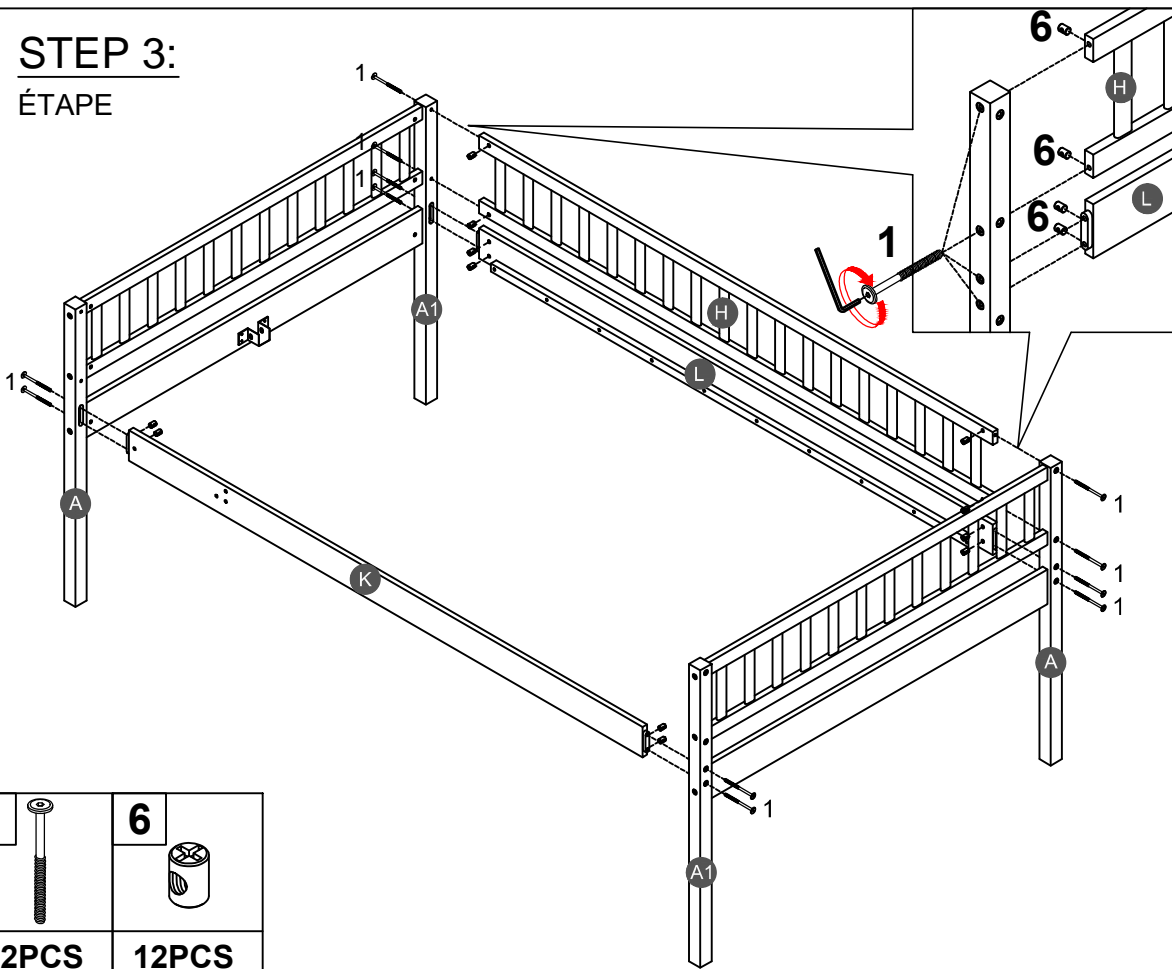

STEP 3:
ÉTAPE



1		6	
12PCS		12PCS	

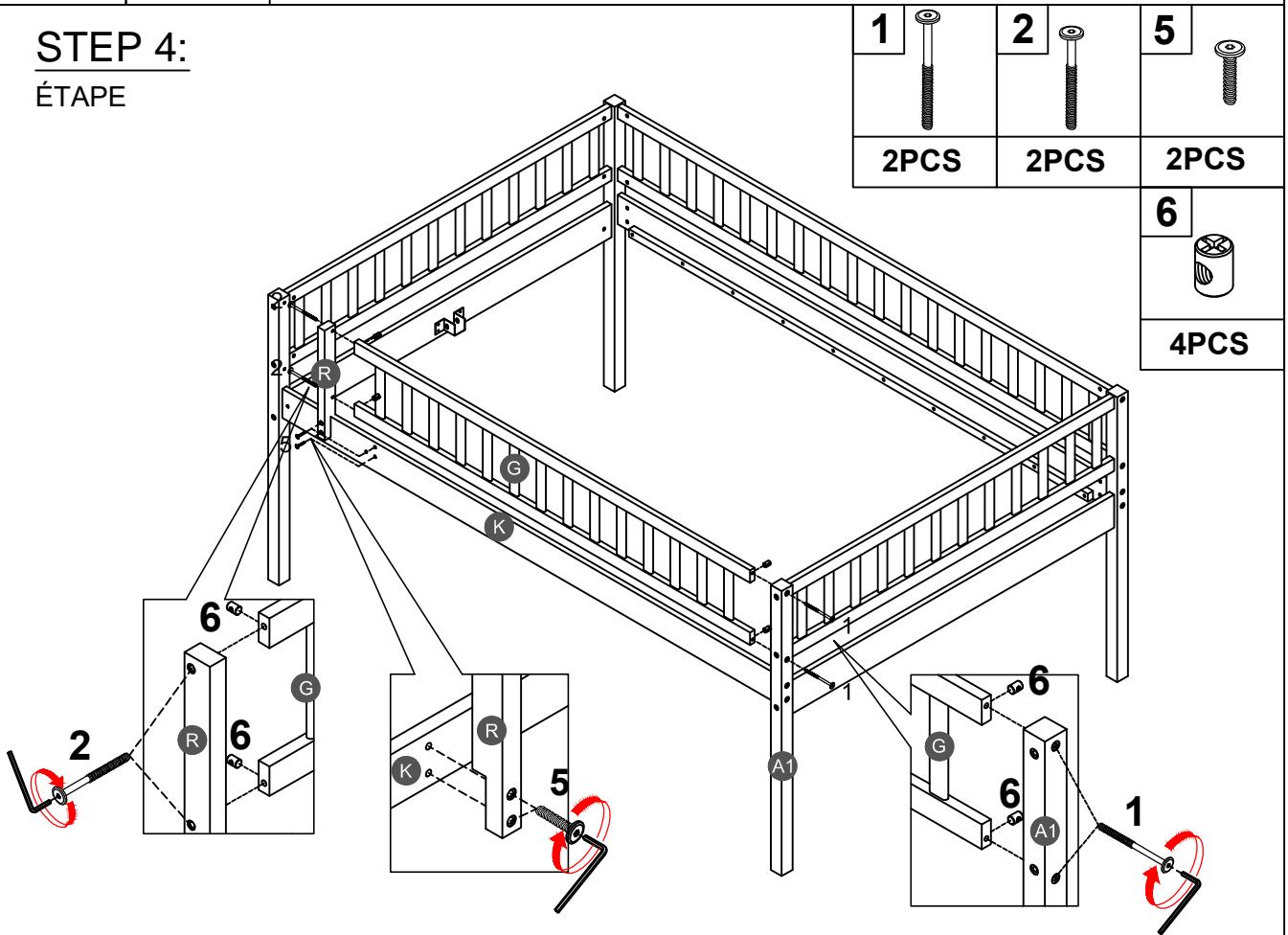

STEP 4:
ÉTAPE



1		2		5	
2PCS		2PCS		2PCS	
				6	
				4PCS	

STEP 5:

ÉTAPE

4		10	
2PCS		2PCS	

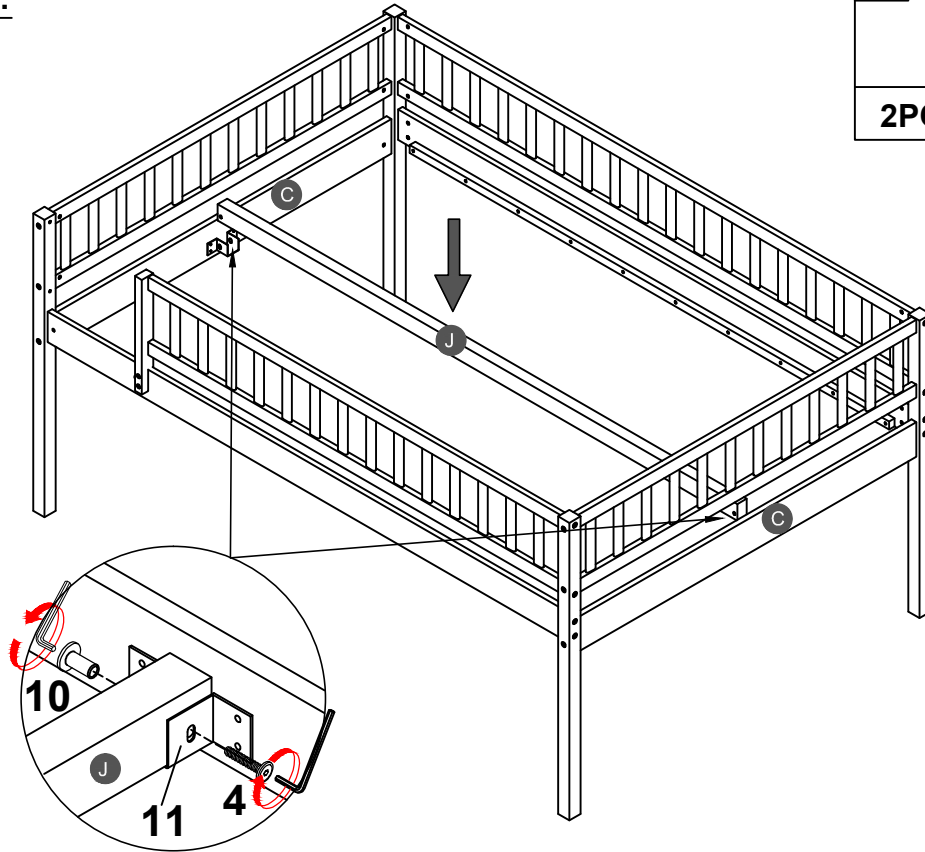

STEP 6:

ÉTAPE

8	
34PCS	

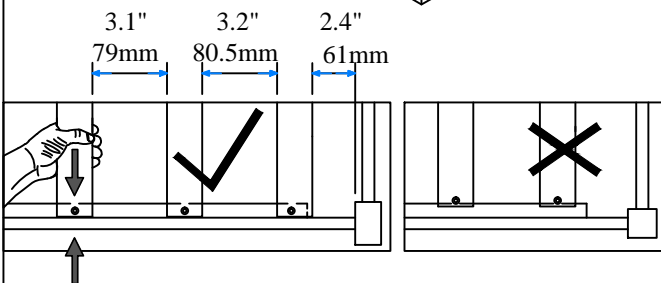
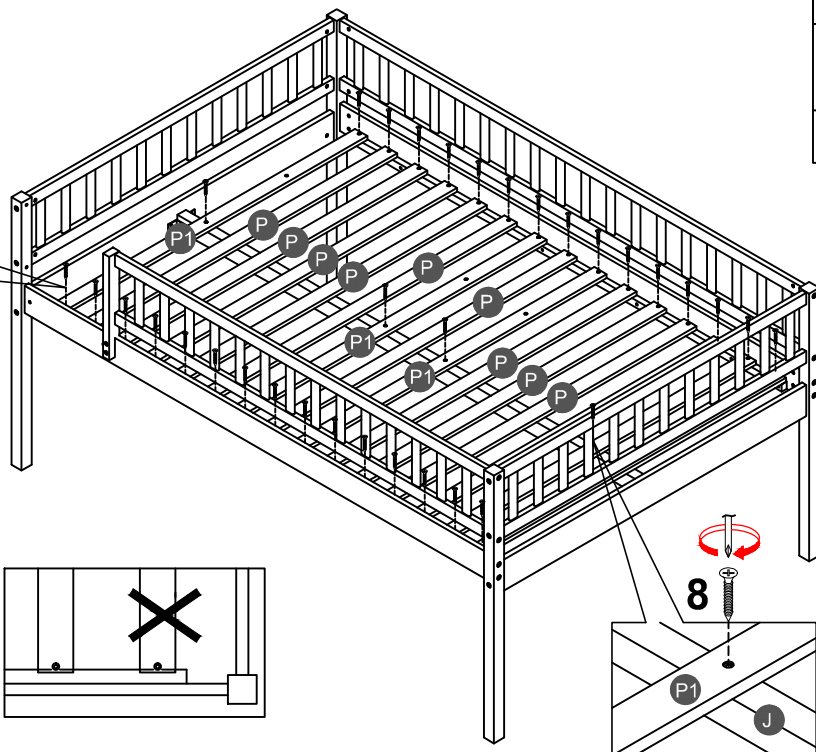
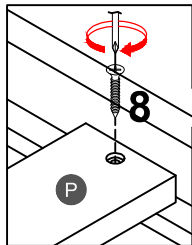



NOTE: Please make sure the bed slats close to the side rail before locking the screws to avoid breakage. This step is required for both the left and right sides. Moreover, please do not lock the screws of the bed slats at the outermost edge to avoid damaging.

Remarque: Assurez-vous Les lattes du lit fermer du rail latéral avant de verrouiller les vis pour éviter la casse. Cette étape est requise pour tous les deux côtés gauche et droit. De plus, ne verrouillez pas les vis des lattes de lit sur le bord le plus extérieur pour éviter d'endommager.

STEP 7:

ÉTAPE

2		6	
12PCS		12PCS	

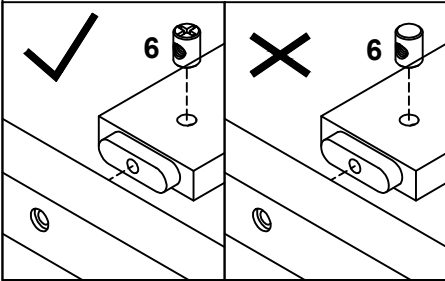
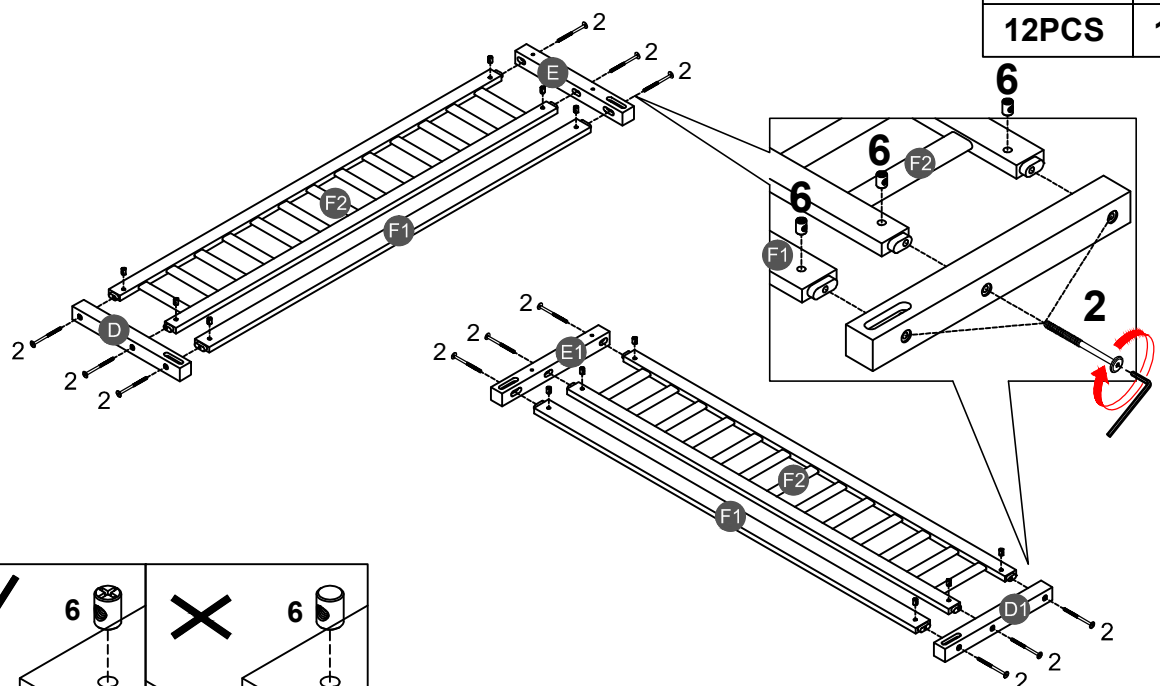

Note: Part 6 will face up with the "x" mark on it, otherwise it cannot be tightened

Remarque: La pièce 6 sera face vers le haut avec la marque "x", sinon elle ne peut pas être serrée.

STEP 8:

ÉTAPE

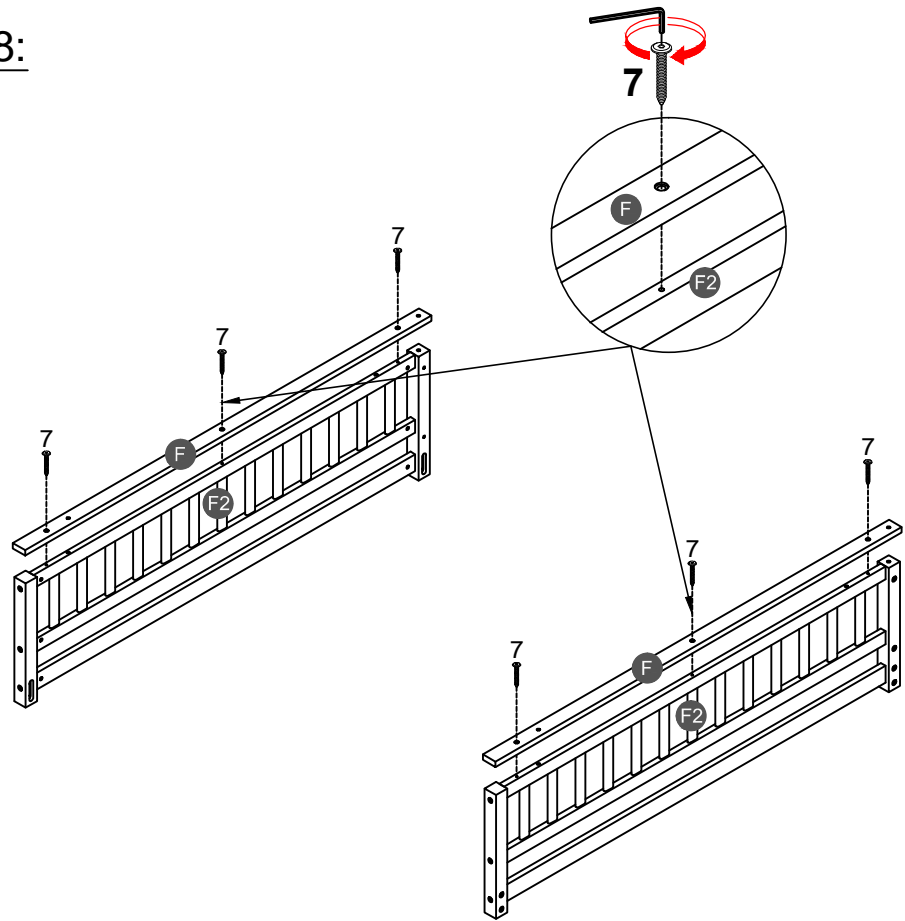

7	
6PCS	

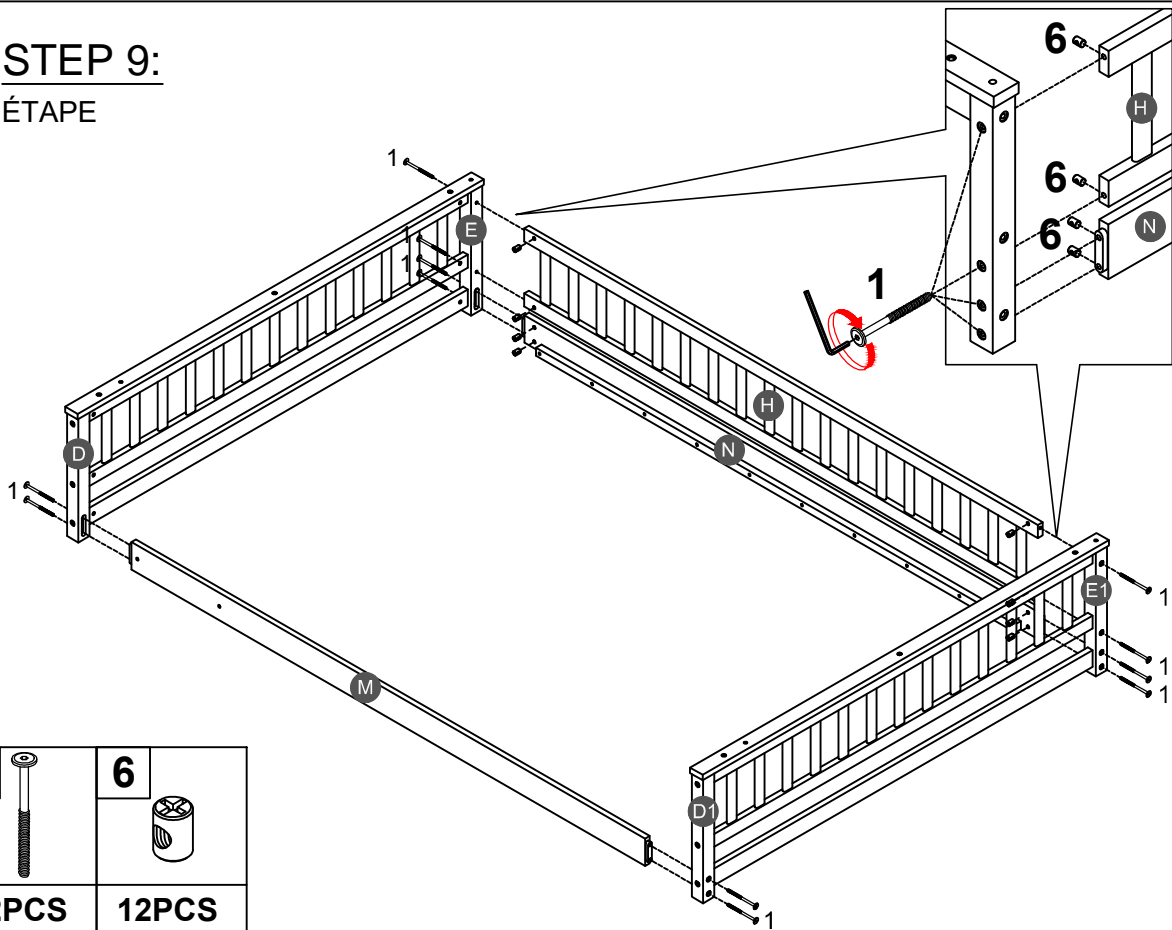

STEP 9:

ÉTAPE



1		6	
12PCS		12PCS	

STEP 10:

ÉTAPE

8



14PCS

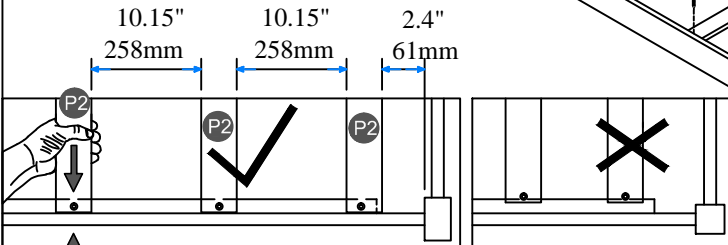
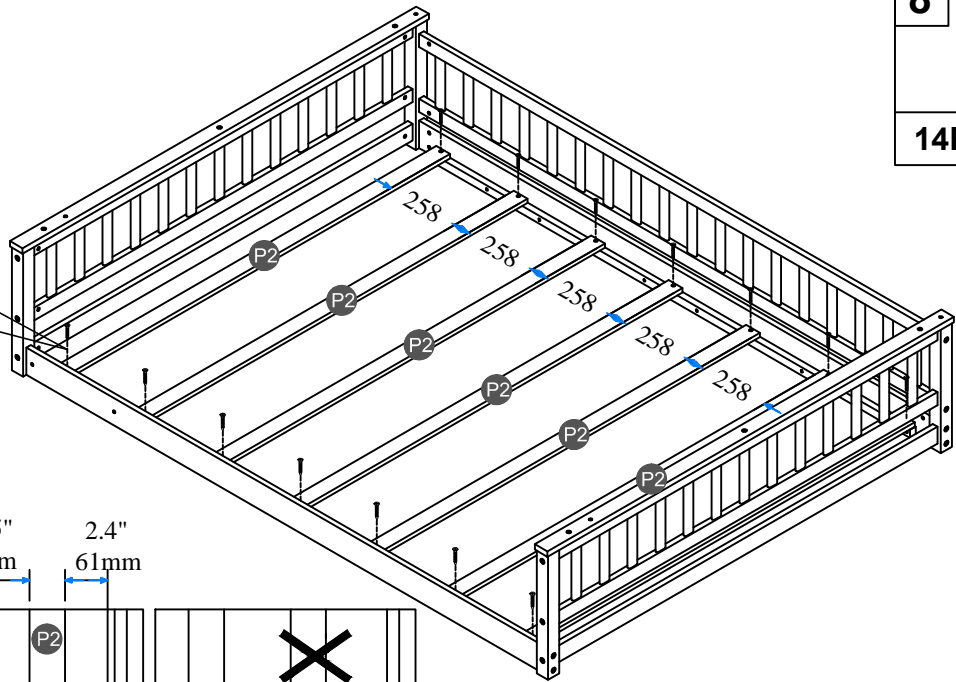
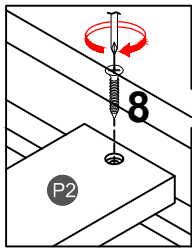

NOTE: Please make sure the bed slats close to the side rail before locking the screws to avoid breakage. This step is required for both the left and right sides. Moreover, please do not lock the screws of the bed slats at the outermost edge to avoid damaging.

Remarque: Assurez-vous Les lattes du lit fermer du rail latéral avant de verrouiller les vis pour éviter la casse. Cette étape est requise pour tous les deux côtés gauche et droit. De plus, ne verrouillez pas les vis des lattes de lit sur le bord le plus extérieur pour éviter d'endommager.

STEP 11:

ÉTAPE

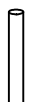
12	
4PCS	

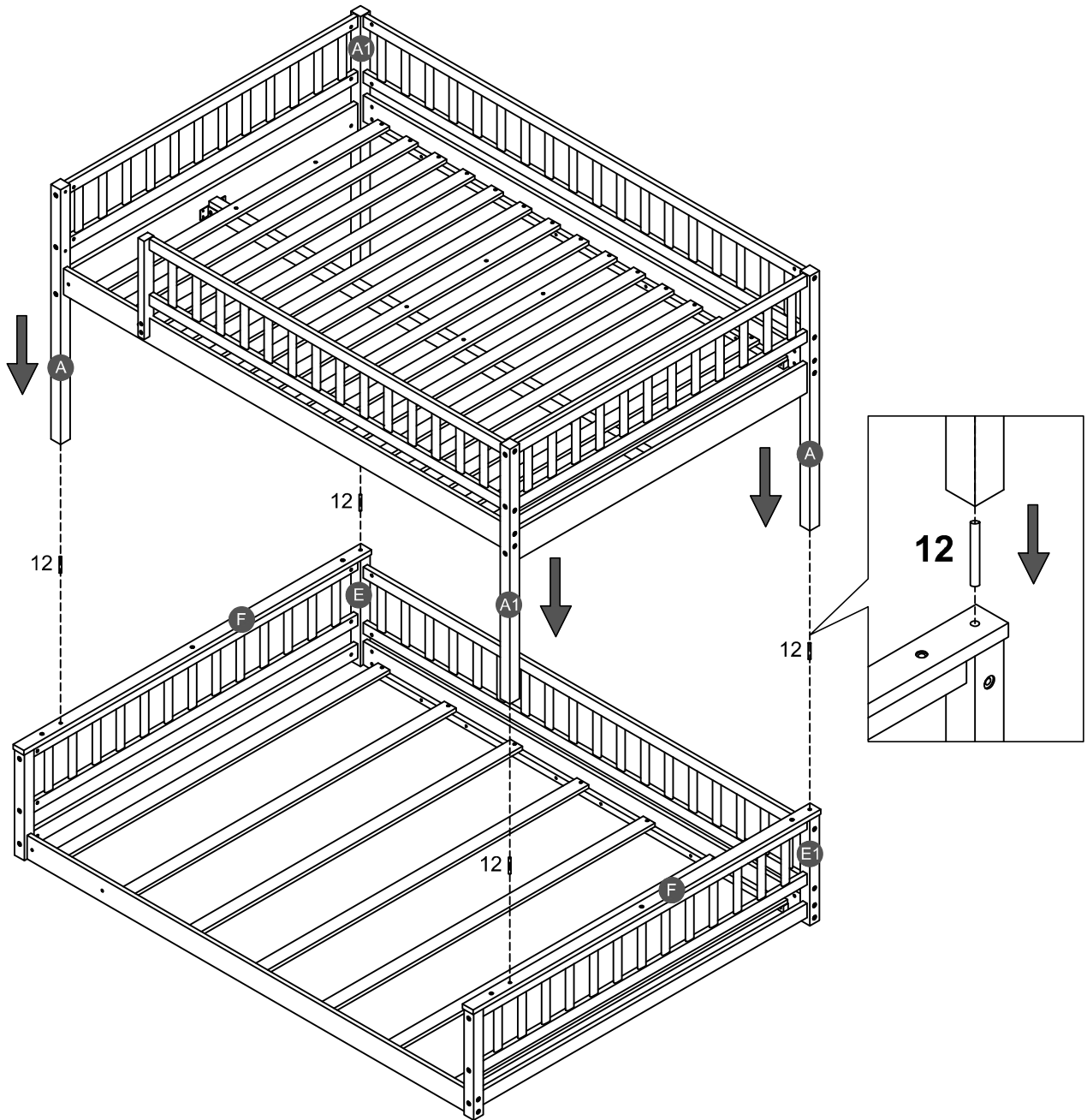

STEP 12:

ÉTAPE

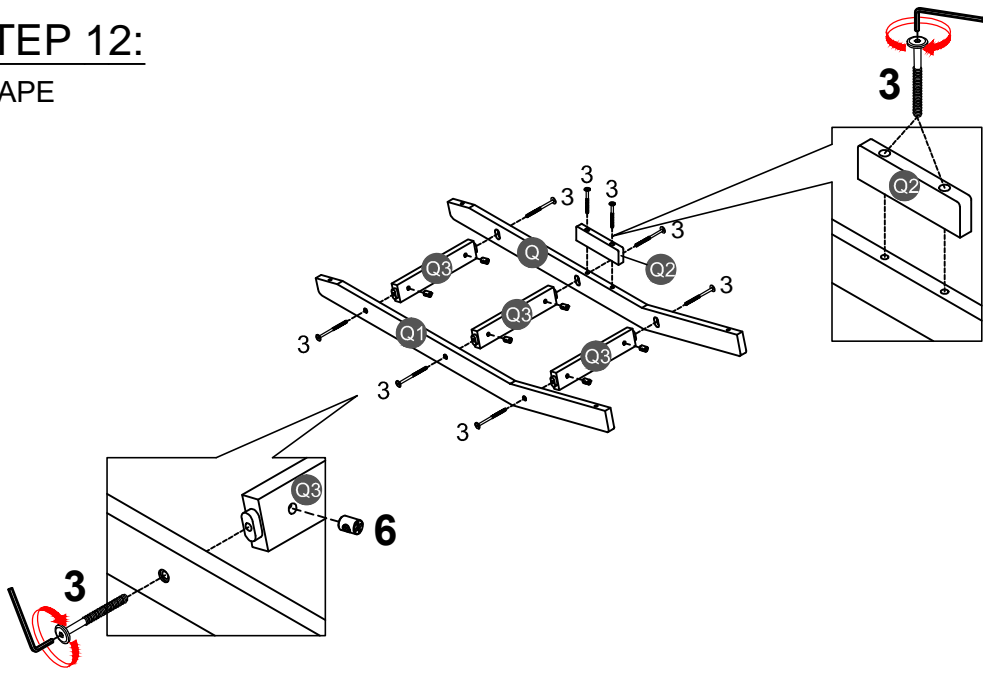

3



8PCS

6



6PCS

STEP 13:

ÉTAPE

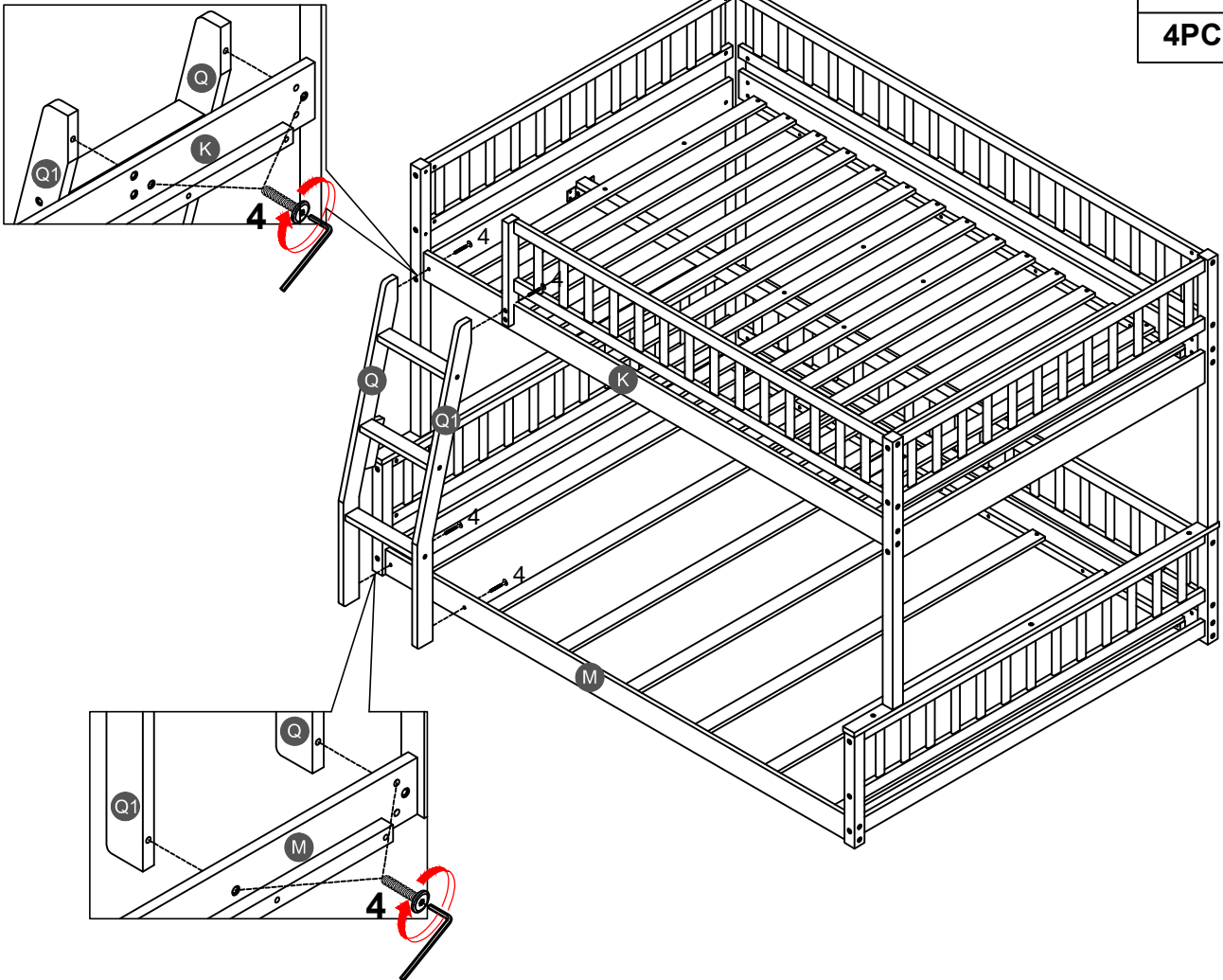

4



4PCS