

Assembly Instructions

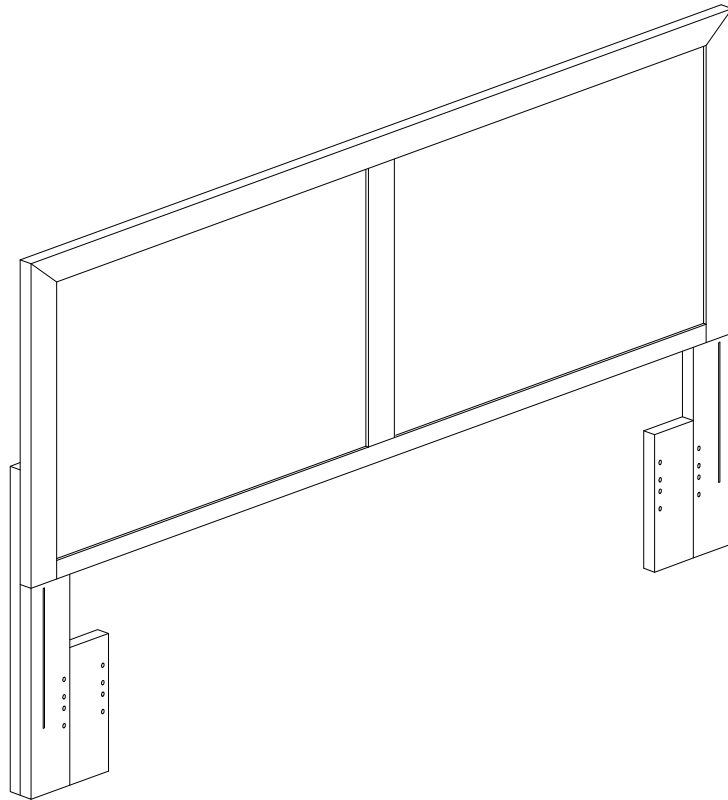

ASSEMBLY RATING

The Assembly Rating is a 5-point system that shows the degree of effort needed in assembling a specific product (with 1 being easy and 5 being difficult). For some products, two persons are recommended.

EASY  DIFFICULT

Tools Required For Assembly:

Allen Wrench

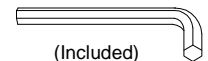

(Included)

Wrench

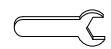

(Included)

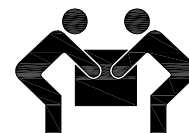

2 PERSONS RECOMMENDED

ASSEMBLY & CARE ADVICE

FOR YOUR FURNITURE TO LAST, CORRECT ASSEMBLY AND PROPER MAINTENANCE ARE NECESSARY. PLEASE FOLLOW THE INFORMATION PROVIDED BELOW TO FULLY ENJOY YOUR FURNITURE.

BASIC ASSEMBLY TECHNIQUES

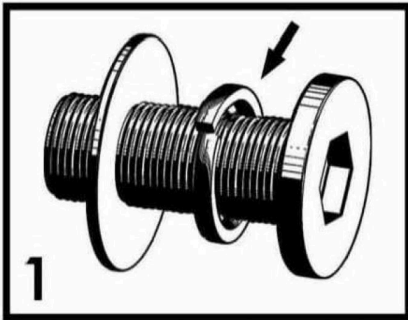

When lock or spring washer is used in an assembly, please make sure the lock or spring washer is placed between the larger flat washer and the head of the screw or bolt.

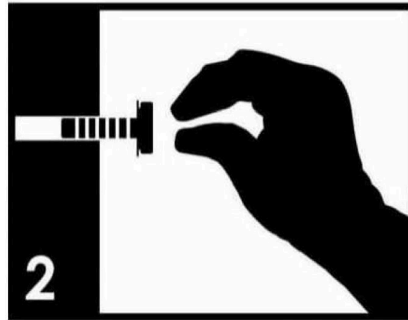

Position each part correctly and insert screws or bolts into their respective holes by hand tighten or using the proper hand tool. Only tighten when step is completed or when instructed to do so.

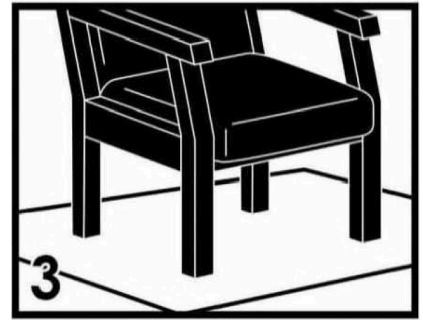

Use cardboard or carpet area when assembling furniture to prevent scratches. Make sure the furniture rests on a flat and level surface with each leg evenly touching the floor.

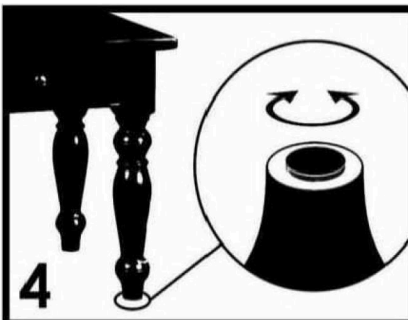

Some furniture comes with height adjustment knobs underneath each leg. To lower or to raise each leg, you need to turn clockwise or counterclockwise, respectively.

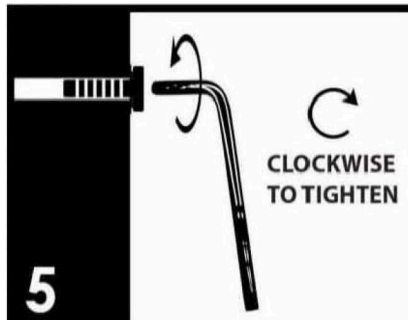

Make sure all parts are properly aligned, then use the appropriate hand tool to completely tighten the bolts or screws. Do not use power tools and do not overtighten.

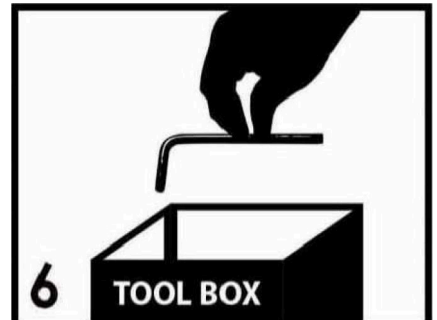

Save the instructions and store the Allen wrench or any supplied tool for later maintenance. After two weeks, check and tighten any loose hardware and repeat again every six months thereafter.

IT IS THE USER'S RESPONSIBILITY TO MAINTAIN THE FURNITURE. THE HARDWARE MAY LOOSEN OVER TIME AND MAY CAUSE THE FURNITURE TO BE WOBBLY AND UNABLE TO SUPPORT ITS INTENDED WEIGHT CAPACITY. THIS MAY LEAD TO COLLAPSE AND MAY CAUSE SERIOUS INJURY.

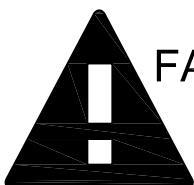

FAILURE TO FOLLOW THE GUIDELINES ABOVE MAY RESULT IN INJURY AND/OR PROPERTY DAMAGE.

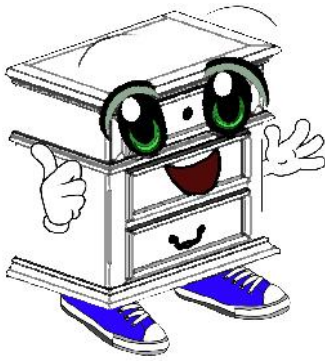

Before you begin, please read Page 2 of "Assembly and Care Advice".

And remember, do not tighten until each step is completed or instructed.

Parts List

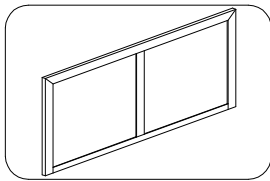

#1 x 1pc
Headboard

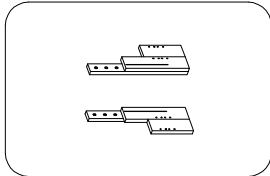

#2 x 2pcs
Headboard Leg L/R

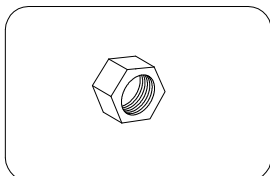

#H x 4pcs
Hex Nut

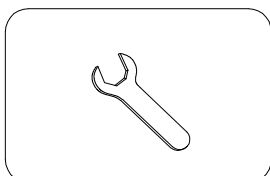

#I x 1pc
Flat Wrench

Hardware List

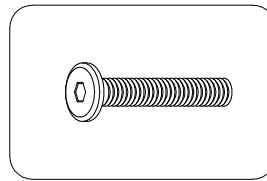

#A x 6pcs
Bolt 5/16" x 1-3/8"

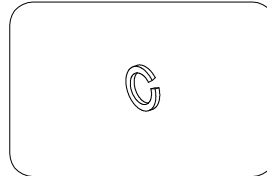

#B x 6pcs
Lock Washer 5/16"

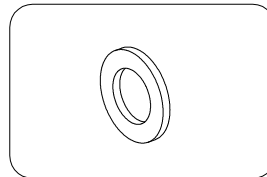

#C x 6pcs
Flat Washer 5/16"

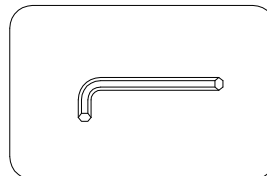

#D x 1pc
Allen Wrench

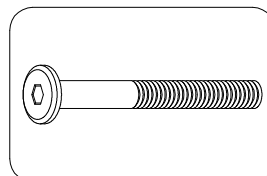

#E x 4pcs
Bolt 1/4" x 3-1/8"

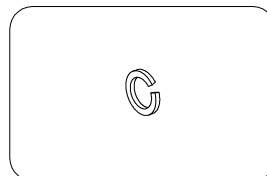

#F x 8pcs
Lock Washer 1/4"

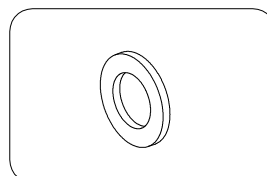

#G x 8pcs
Flat Washer 1/4"



#1

#A x 6pcs
 #B x 6pcs
 #C x 6pcs

1. Align the headboard legs (#2) to the holes along the back of the headboard (#1). Note, right and left is determined by facing the front of the headboard (#1).

2. Prepare 6 bolt assemblies by inserting a lock washer (#B) onto the bolt (#A) then a flat washer (#C) onto that same bolt (#A). Insert 3 bolts into each leg and secure using the Allen wrench (#D).

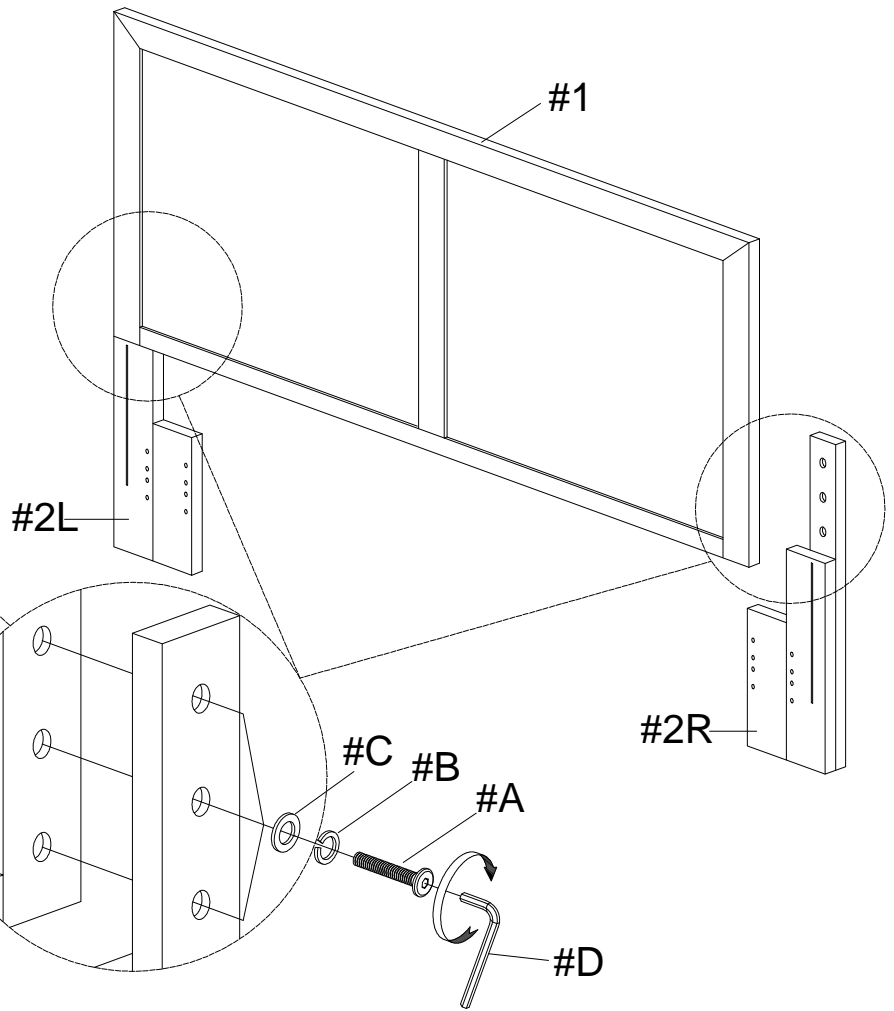

#2

#E x 4pcs
 #F x 8pcs
 #G x 8pcs
 #H x 4pcs

1. Align the ends of the railing to the headboard legs (#2).

2. Prepare 4 bolt assemblies by inserting a lock washer (#F) onto the bolt (#E) then a flat washer (#G) onto that same bolt (#E). Insert 2 into the back of each leg (#2), secure using the Allen wrench (#D).

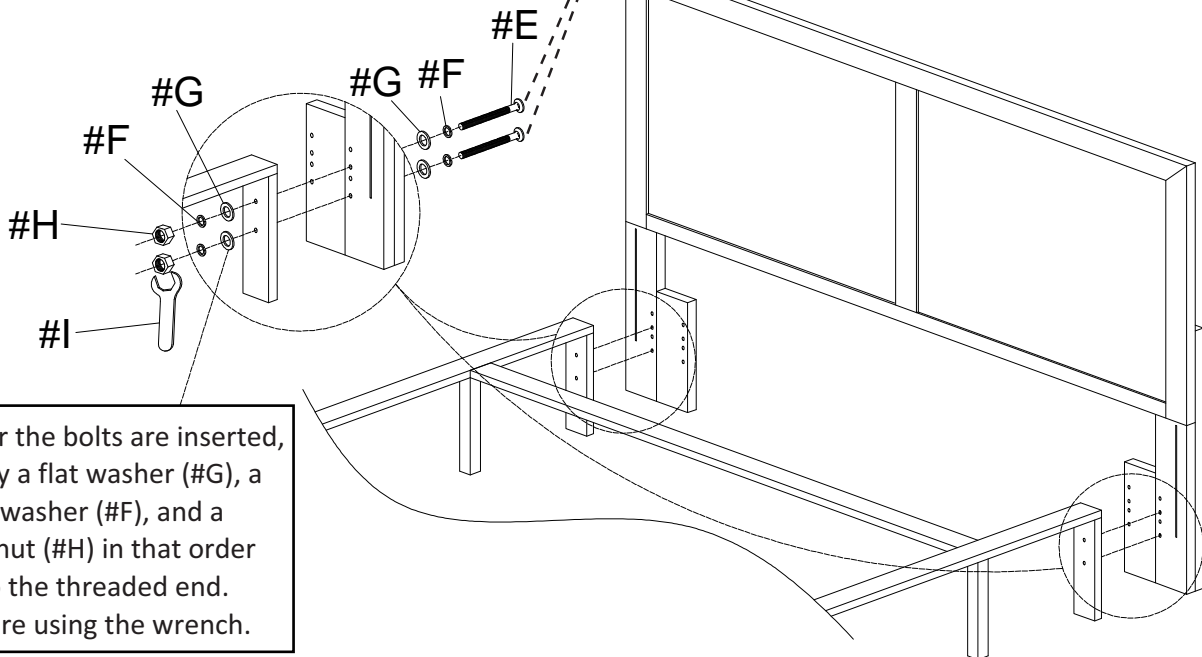

3. After the bolts are inserted, apply a flat washer (#G), a lock washer (#F), and a hex nut (#H) in that order onto the threaded end. Secure using the wrench.

ASSEMBLY IS COMPLETED

Thank you for your purchase!

We hope you will enjoy your new product for many years to come. Our commitment to providing quality products does not simply end when a purchase is made. We stand behind our products and will provide any support needed in order for you to fully enjoy your purchase. Your satisfaction is the greatest recognition we could have.

Because we value your trust in our company, we will do our best to meet your service expectations. Should you have any assembly related questions, parts replacement requests, comments or suggestions, please feel free to contact us any time. To help expedite the service, please have the assembly instructions available, along with your order receipt.