

# Owner Manual

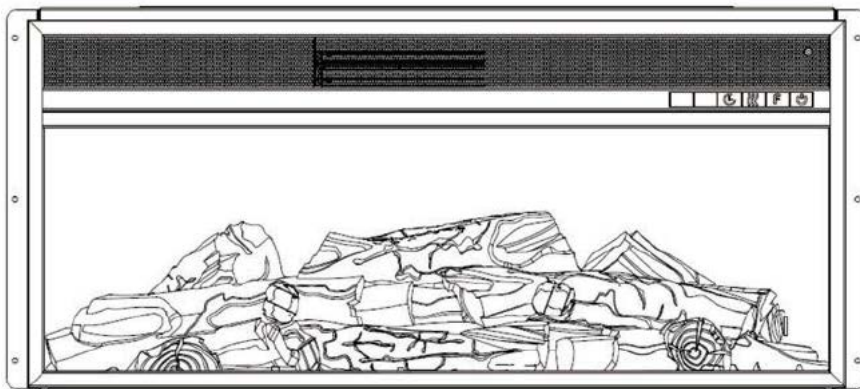

**Only use this heater as described in this manual.** Any other use is **not** recommended by the manufacturer, and may cause **fire, electric shock, or other personal injury.**



**WARNING!** Read and understand this entire owner's manual, including all **safety information, before plugging in or using** this product. Failure to do so could result in **fire, electric shock, serious personal injury, or death.**



**WARNING! INDOOR use only! NEVER use this heater outdoors!**

## SAVE THESE INSTRUCTIONS!



**CAUTION!** Keep this owner's manual for future reference. If you sell or give this product away, make sure this manual accompanies this product.

# IMPORTANT SAFETY INFORMATION!



## WARNING



- **ALWAYS** keep electric cords, home furnishings, drapes, clothing, papers, or other combustibles at least **3 feet (0.9m)** away from the front of this heater, and away from the bottom, sides, and rear of this heater.
- **DO NOT** place the heater near a bed because objects such as pillows or blankets can fall off the bed and be ignited by the heater.
- **DO NOT COVER** this heater or **block** the air vents at all. Doing so could cause a fire.
- **AVOID fire or electric shock! NEVER** insert or allow any foreign objects to enter the ventilation or exhaust openings of this heater.
- **Prevent Fire!** Keep all **flammable liquids**, like gasoline or paint, away from this heater. This heater produces **arcing sparks** that could **ignite** flammable liquids.
- **DO NOT cover** this heater in any manner. Doing so could block the air flow and cause the unit to **overheat**, or could **ignite** the material covering the heater.
- **NEVER** run the **power cord** under carpet, rugs, runners, or any other covering. Doing so could cause the cord or materials covering the cord to overheat.
- **AVOID FIRE!** Regularly inspect all air vents to make sure they are free from dust, lint, or other blockage. **Unplug the unit** and clean with a **vacuum ONLY**. **DO NOT** rinse or get wet.



## WARNING



- **For residential use only! NOT for commercial use! NEVER** use this fireplace for other than its intended purpose.
- **Only** use this insert with the mantel that came with the insert. **NEVER** use a mantel from another manufacturer.
- **NEVER** use this electric fireplace insert unless it is **properly installed** in the correct mantel.
- Use **extreme caution** if using this heater **near children**, or where children may be present.
- **NEVER** leave this heater unattended. **ALWAYS** unplug this heater when not in use.
- This heater is hot when in use. **AVOID INJURY! DO NOT TOUCH** hot surfaces, or attempt to move this heater while it is hot.

- **ALWAYS** turn this heater off before unplugging it from the outlet.
- **AVOID INJURY!** Keep the cord from crossing traffic areas to avoid tripping.
- **NEVER modify this fireplace.** Doing so could result in personal injury or property damage. Modification of this fireplace **completely voids all warranties.**
- **Discontinue use** if this fireplace **malfunctions** or is **dropped or damaged in any manner.**



## WARNING



- **Risk of electric shock! DO NOT OPEN!** No user-serviceable parts inside!
- **ALWAYS disconnect** this unit from the **power supply before** performing any assembly or cleaning, or before relocating the electric fireplace.
- **ALWAYS** store this heater in a dry location. **NEVER** use the fireplace if it has become wet.
- **NEVER** use this heater in **bathrooms, laundry rooms,** or any other location where the heater could fall into a **bathtub or pool, become damp or come in contact with water.**
- **NEVER** hang this unit on a wall **directly below an electrical outlet.**
- **NEVER** operate this heater if the **power cord** or **plug** has become **damaged,** or if the **grounding pin** is **damaged or missing.**
- **ONLY** use this heater on a **250Volt 16Amp grounded circuit. NEVER overload the circuit.** If this heater trips the circuit breaker, unplug all other appliances on the same circuit before the next use. Avoid plugging other appliances into the same circuit as this heater.
- **NEVER** plug this heater into an outlet that is **old, cracked,** or has any **loose wires or connections.** Plugging this heater into a faulty outlet could result in **electric arcing** within the outlet that could cause the **outlet to overheat or catch fire.**
- **ALWAYS** check your heater cord and plug connections with **each use!**
  - i) **MAKE SURE** the plug fits tight in the outlet! Faulty wall outlet connections or loose plugs can cause the outlet to overheat.
  - ii) **Heaters draw more current** than small appliances. **Overheating** may occur even if it has not occurred with the use of other appliances.
  - iii) During use **check frequently** to see if the **plug outlet or face plate is HOT!**
  - iv) If the outlet or face plate is **HOT, discontinue use immediately** and have a qualified electrician inspect and/or replace the faulty outlets.

- The cord supplied with the heater has a plug with three flat blades (live, neutral and ground). If a 3-slot receptacle is not available, an adapter **MUST** be used. The adapter **MUST** be properly grounded to the outlet box (see figure at right).

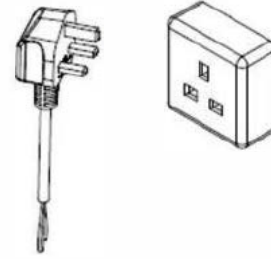

## PREPARATION



This insert has front panel made of **GLASS!** **ALWAYS** use **extreme caution** when handling **glass**. Failure to do so could result in **personal injury** or **property damage**.

Remove all parts and hardware from the carton and place them on a clean, soft, dry surface. Check the parts list to make sure nothing is missing. Dispose of packaging materials properly. Please recycle whenever possible.



**Tools required for assembly:** Screwdriver (Not included)

## PARTS & HARDWARE

Item	Description	Qty
(1)	Screws	6
(2)	Manual	1
(3)	Remote control	1



**ALWAYS unplug** this fireplace heater **before assembly** or **cleaning**, or **before relocating**. Failure to do so could result in **electric shock, fire, or personal injury**.

## ASSEMBLY

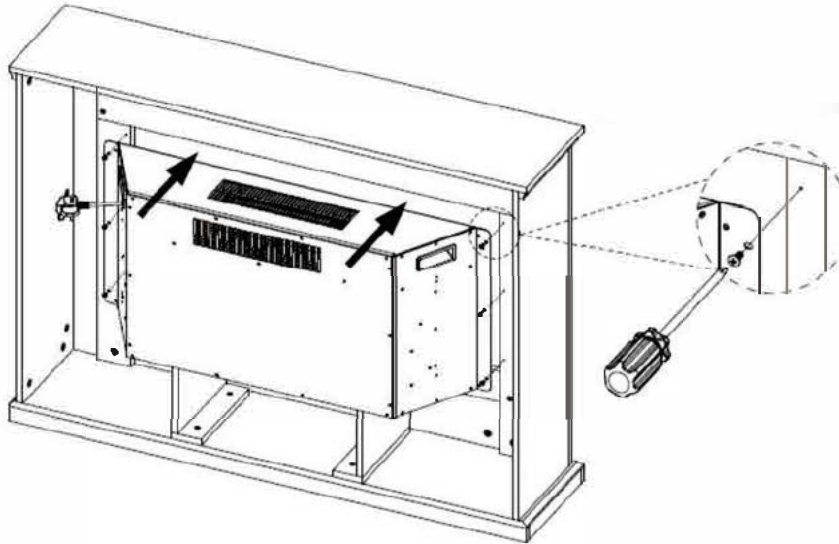

**NOTE:** See mantel owner's manual for instructions on mantel assembly.

Fig.1

**STEP 1.** Slide insert into mantel from behind. Center insert in opening with trim flush against inner surface of front mantel wall.

**STEP 2.** Thread 6 screws (1) through holes in trim and into mantel frame. Check insert alignment and tighten all screws securely with a screwdriver.

## OPERATION



**Read and understand** this entire owner's manual, including **all safety information**, **before plugging in** or **using** this product. Failure to do so could result in **electric shock, fire, serious injury, or death**.

### Power

Make sure the ON/OFF switch, located on the control panel, is in the OFF position. Plug the power cord into a 250Volt 16Amp grounded outlet (see **IMPORTANT SAFETY INFORMATION** on **Pages 3 and 4**). Make sure the outlet is in good condition and that the plug is not loose. **NEVER** exceed the maximum amperage for the circuit. **DO NOT** plug other appliances into the same circuit.

### Methods of Operation

The fireplace control functions can be accessed in two ways:

1. Using the control panel, located on the upper right-hand of the fireplace (Fig.2).
2. Using the remote control (Fig.4), functions same as control panel (Fig.3).

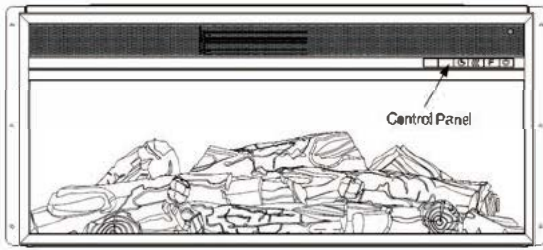

Fig.2

**Control Panel:**

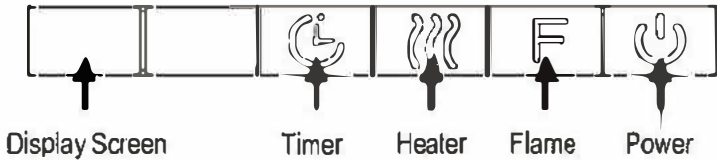





Fig.3

BUTTON	ACTION / FUNCTION	INDICATION / RESULT
	<ol style="list-style-type: none"> <li>1. Press once to turn on flame effect, fuel bed lights, and enable control panel &amp; remote control.</li> <li>2. Press again to turn off flame effect, and shut off power to remote control, and all functions.</li> </ol>	<ol style="list-style-type: none"> <li>1. Flame effect and fuel bed turn on. Indicator light turns on. Control panel &amp; remote control are enabled.</li> <li>2. Flame effect and indicator light turn off. The control panel and remote control will not function.</li> </ol>
	<p>The FLAME button controls the brightness of the flame effect.</p> <p>Press the button to set the flame effect from the highest to lowest setting.</p>	<p>The flame effect cycles through different levels, then returns to the original level.</p> <p>The highest level is 5. There are totally 5 levels flame of the flame brightness (5,4,3,2,1).</p>
	<p><b>Flame effect must be ON for heater to function.</b></p> <ol style="list-style-type: none"> <li>1. Press once for "L" heat (900W).</li> <li>2. Press twice for "H" heat (1800W).</li> <li>3. Press the third time for "Auto" function(A), after that the thermostat starts to work and to setup desired setting before BLUE indicator light fading way.</li> </ol>	<ol style="list-style-type: none"> <li>1. Heater &amp; fan turn on low (900W). Indicator light turns on. Warm air blows.</li> <li>2. Heater &amp; fan turn on high (1800W). Indicator light turns on. Hot air blows.</li> <li>3. The highest temperature of thermostat is 36°C and the lowest is 18°C. The thermostat is adjustable by 2 °C. Once activate the HEATER, the display screen will display the heater setting in using accordingly shortly. You may turn off the HEATER BY this button as well.</li> </ol>
	<p><b>Timer function</b></p> <p>Press the TIMER button will turn on the timer function</p>	<p>Press the timer button will cycle through the 10 timer settings (30mins,1H, 2H,3H,4H,5H,6H,7H,8H,9H). The display screen will present the setting shortly.</p>

## NOTICE

To improve operation, **DO NOT** press the buttons too quickly. Give the unit time to respond to each command.

## ! WARNING!

**NEVER** leave heater unattended during operation! Failure to do so could result in **personal injury** or **property damage**.

## NOTICE

When the heater is first turned on, a slight odor may be present. This is normal and should not occur again unless the heater is not used for a long period of time.

### Infrared Remote Control:

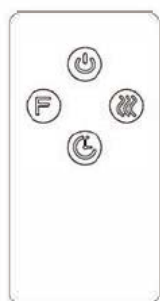

Fig.4

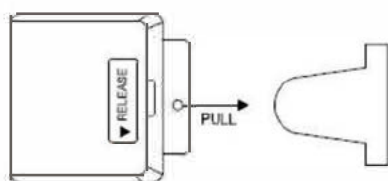

Fig.5

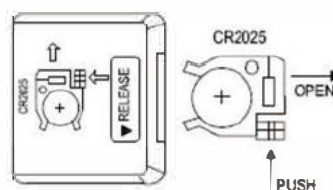

Fig.6

Remote control requires one 3V CR2025 Lithium Cell Battery(included). Remove the protective sheet between the battery and the contacts in order to operate (see Fig. 5 and Fig.6).

### REPLACE THE REMOTE CONTROL BATTERY

When the remote control stops operating or its range seems reduced, it is time to replace the battery with a new one.

1. The battery compartment is located on the back end of the remote.
2. Press and slide the battery door open and remove the old battery.
3. Insert a CR2025 battery, checking that the "+" and "-" terminals of the battery matches the inside of the battery compartment.
4. Replace the battery compartment door.

**DO NOT** mix old and new batteries.

**DO NOT** use rechargeable silver oxide cell batteries with remote control unit.

**DO NOT** mix alkaline. Standard (Carbon-zinc). Or rechargeable (Nickel - Cadmium) batteries.

**DO NOT** dispose of batteries in fire. Improper disposal may cause batteries to leak or explode.

## CARE AND MAINTENANCE



**ALWAYS** turn the heater **OFF** and **unplug the power cord from the outlet** before cleaning, performing maintenance, or moving this fireplace. Failure to do so could result in **electric shock, fire, or personal injury.**

### Cleaning



**NEVER** immerse in water or spray with water. Doing so could result in **electric shock, fire, or personal injury.**

#### **Metal:**

- Buff using a soft cloth, slightly dampened with a citrus oil-based product.
- **DO NOT** use brass polish or household cleaners as these products will damage the metal trim.

#### **Glass:**

- Use a good quality glass cleaner and dry thoroughly with a paper towel or lint-free cloth.
- **NEVER** use abrasive cleansers, liquid sprays, or any cleaner that could scratch the surface.

#### **Vents:**

- Use a vacuum or duster to remove dust and dirt from the heater and vent areas.
- Clean the exterior of the fireplace with a slightly damp cloth or duster.

### Maintenance



**Risk of electric shock! DO NOT OPEN! No user-serviceable parts inside!**



**ALWAYS** turn the heater **OFF** and **unplug the power cord from the outlet** before cleaning, performing maintenance, or moving this fireplace. Failure to do so could result in **electric shock, fire, or personal injury.**

#### **Electrical and Moving Parts:**

- The fan motors are lubricated at the factory and will not require lubrication.
- Electrical components are integrated in the fireplace and are not serviceable by the consumer.

#### **Storage:**

- Store heater in a clean dry place when not in use.



**WARNING!** No other servicing should be performed by the consumer. Do not attempt to service the unit yourself.

### **LED light Inspection and Replacement:**

**Note:** The flame effect on this electric fireplace insert is created by LED Bulbs.

The life of these LED bulbs will be 100,000 hours. The users are not recommended to replace the LED Bulbs. For any reason should the bulbs stop working properly, contact a qualified technician.



### **Meaning of crossed –out wheeled dustbin:**

Do not dispose of electrical appliances as unsorted municipal waste, use separate collection facilities. Contact you local government for information regarding the collection systems available.

If electrical appliances are disposed of in landfills or dumps, hazardous substances can leak into the groundwater and get into the food chain, damaging your health and well-being.

When replacing old appliances with new ones, the retailer is legally obligated to take back your old appliance for disposals at least free of charge.