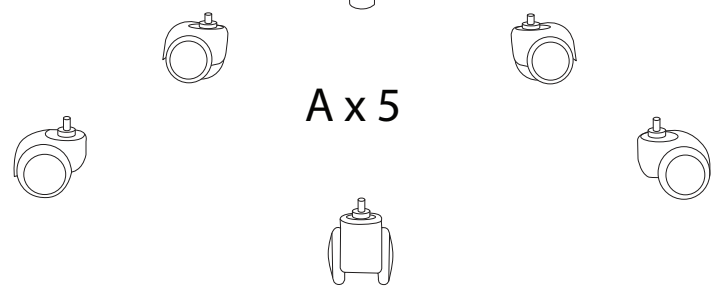
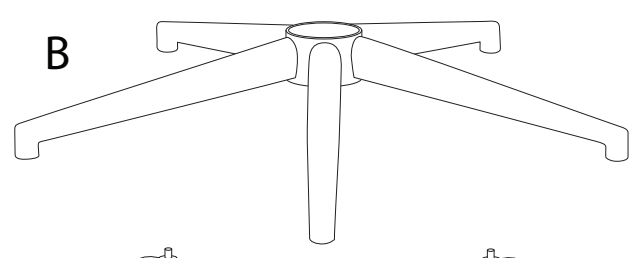
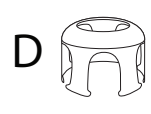
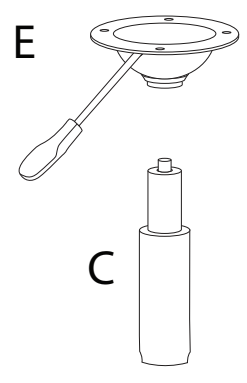
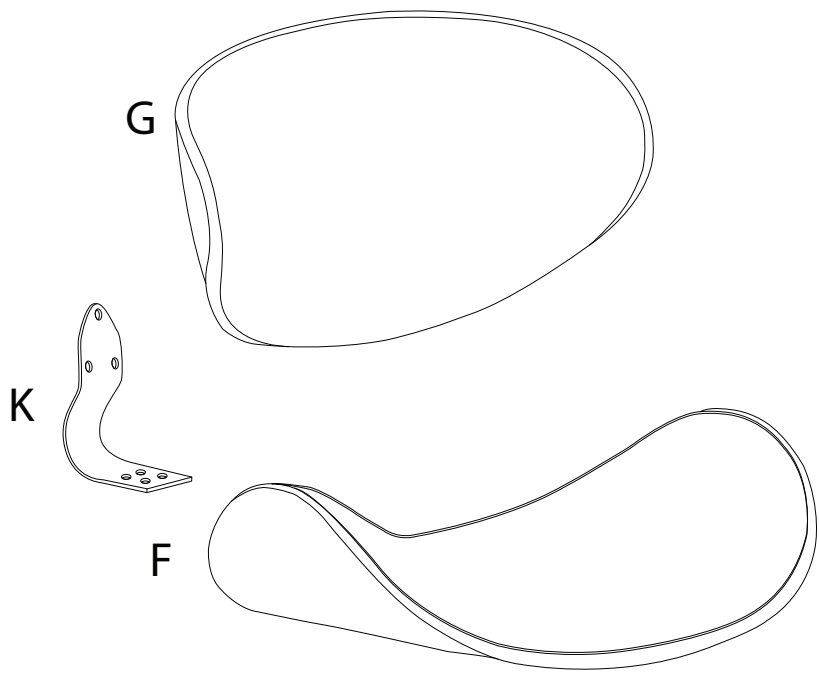
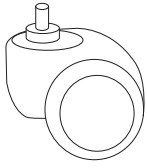

Diagram illustrating assembly instructions and safety warnings:

- Top Section:** Shows an Allen key and a power drill with a diagonal line through it, indicating that a power drill should not be used. A warning triangle with an exclamation mark is positioned to the right. Below this is a clock icon and the text "20'", indicating a 20-minute assembly time.
- Bottom Section:** Shows a rectangular block being placed on a surface with a diagonal line through it, indicating that the chair should not be placed on an uneven or soft surface. A warning triangle with an exclamation mark is positioned to the right. Below this is a person icon and the number "1", indicating that one person is required for assembly.



A



x 5

B

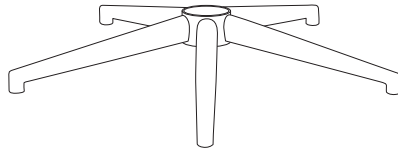

x 1

C



x 1

D



x 1

E

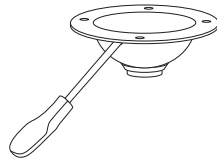

x 1

F

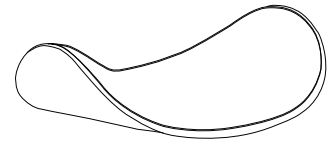

x 1

G

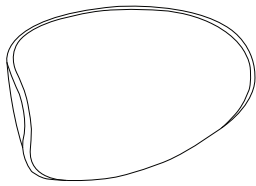

x 1

H



x 7

I

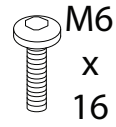

x 4

J

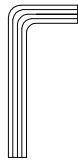

x 1

K

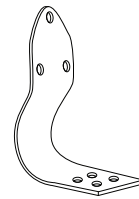

x 1

1

A



x 5

B

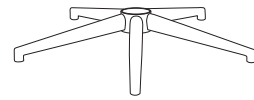

x 1

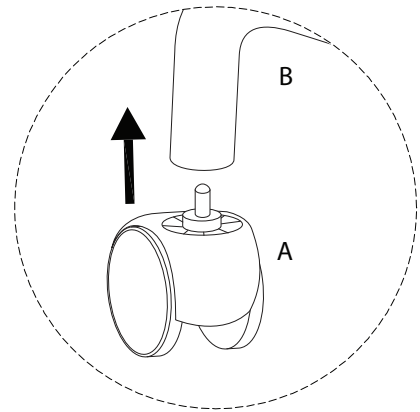
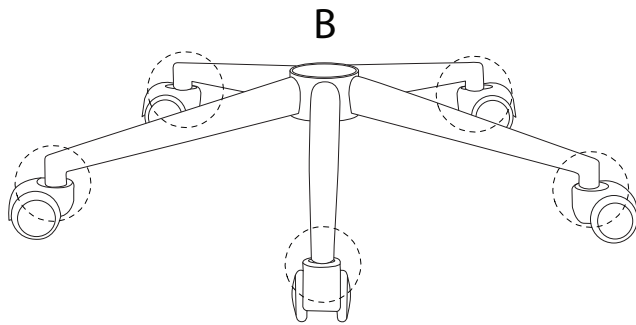

!

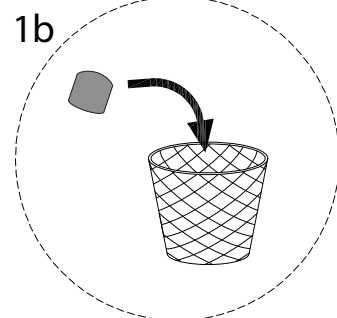
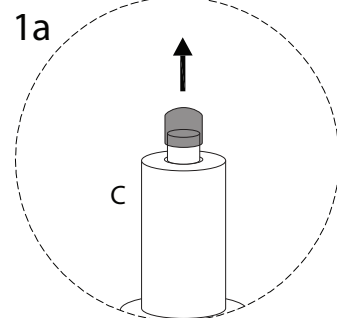
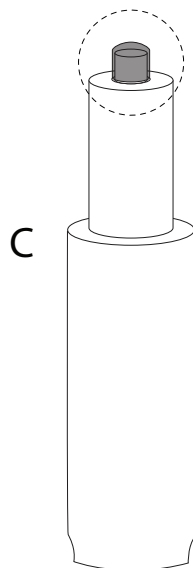

2

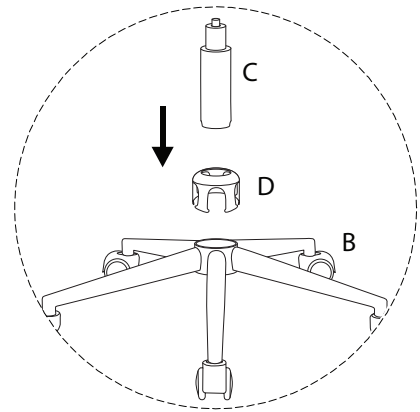
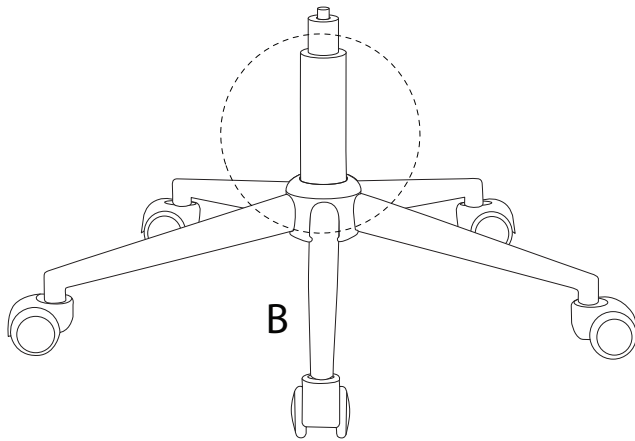
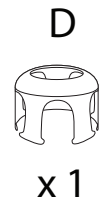
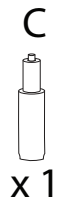

3

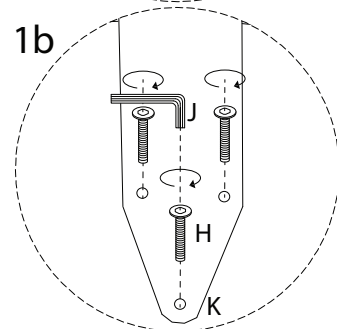
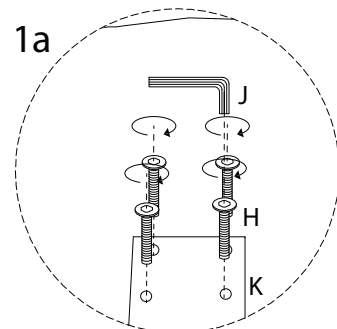
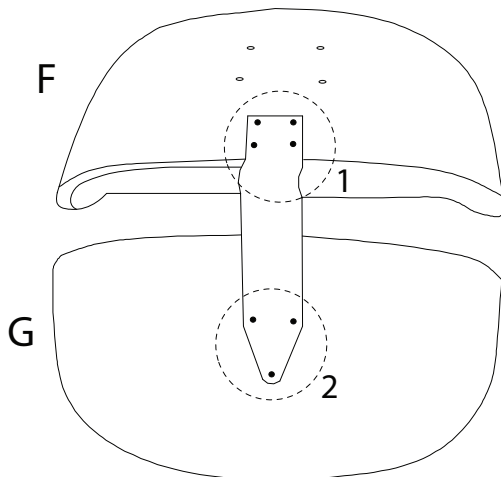
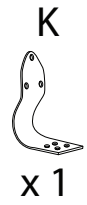
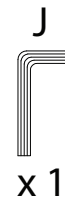
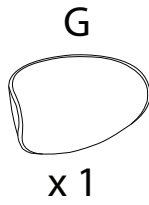
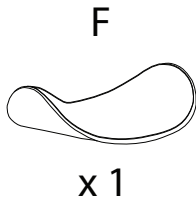

4

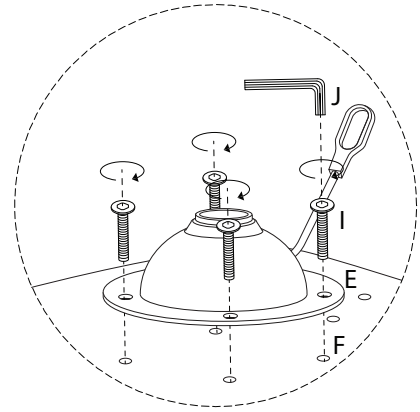
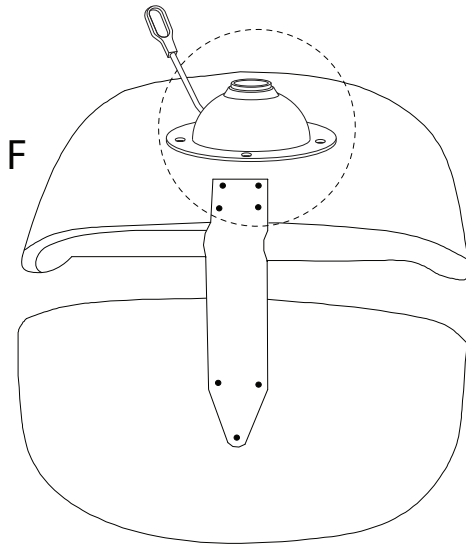
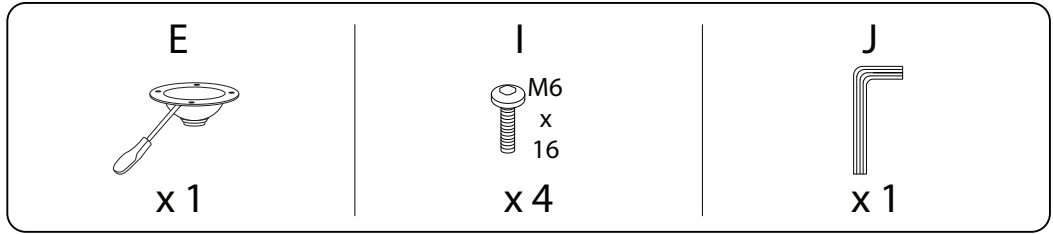

5

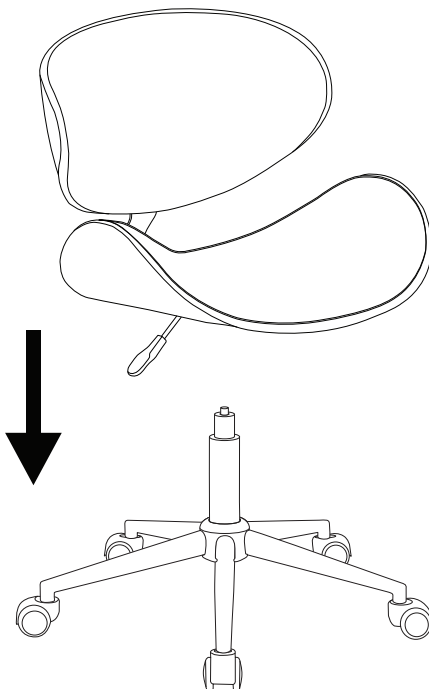

!

