

Assembly Instructions

Caution : You must read this before you proceed

Expandable Table

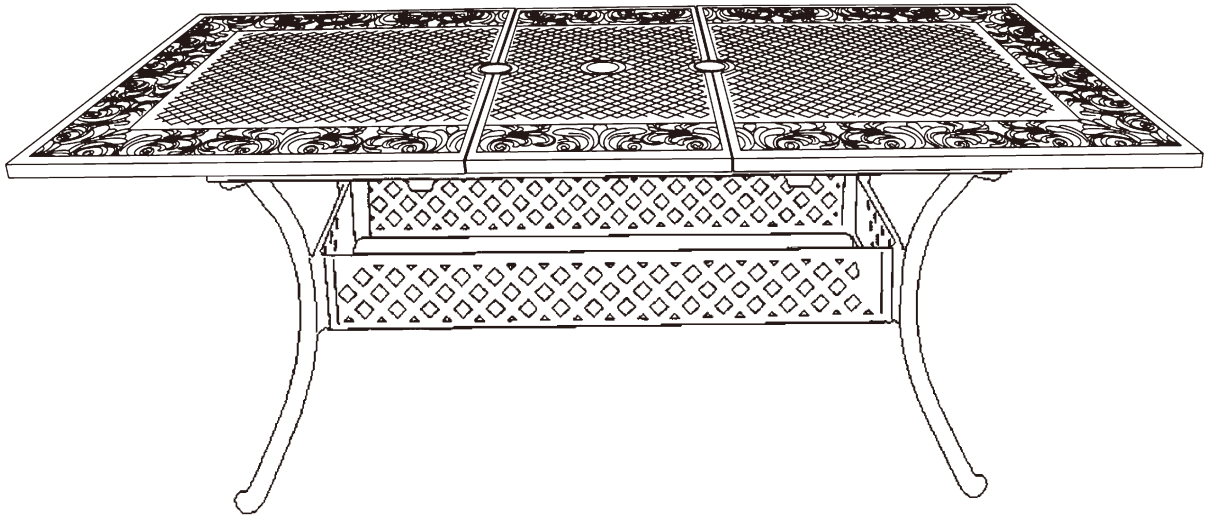





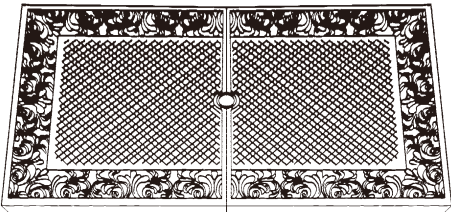

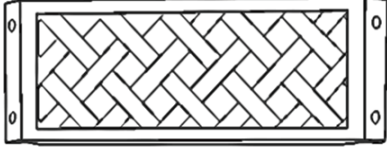
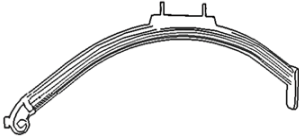
CAUTION : This table is NOT a TOY.
Keep your child / children at bay in the process of assembly.

Parts List

Label	Picture	Description	QTY
A		Table Top	1

B		Long Leg Support	2
C		Short Leg Support	2
D		Table Leg	4

Hardware

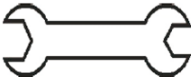
Label	Picture	Description	QTY
①		Studs(M8*40mm)	5
②		Washers(8mm)	13
③		Spring washers(8mm)	13
④		Nuts (8mm)	13
⑤		Nuts Cap (8mm)	9
⑥		Screwdriver	1
⑦		Spanner	1

Assembly Preparation

Before Beginning Assembly:

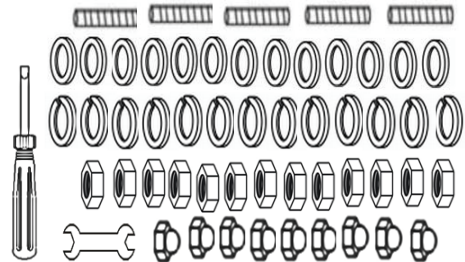
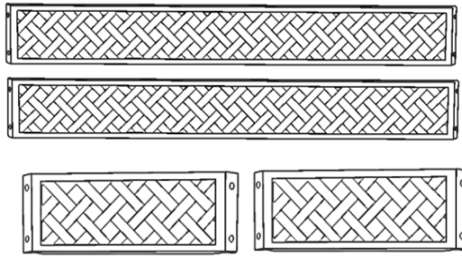
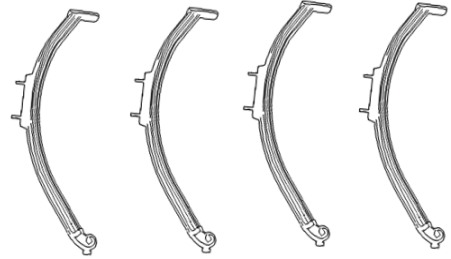
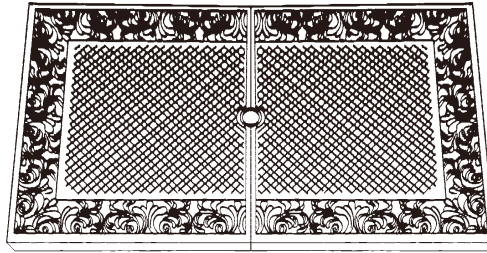

- Read instructions, cover to cover-



- Have 2 adults on hand for assembly-



- Do not assemble on flooring or carpet-



- Assemble on a clean non-marring surface (packing foam)-



- Save all packaging until finished-

Assembly Steps

Overview

A(Table Top)

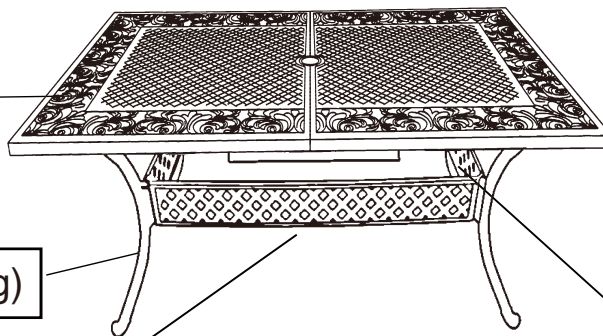

D(Table Leg)

B(Long Leg Support)

C(Short Leg Support)

FRONT FACING

This table has multiple parts and may require up to 30 minutes to assemble. To give you an overview of the table parts, the above picture is to help you put the various parts into perspective. Please read through the instructions below to familiarise yourself with the parts and steps before assembly.

Step 1

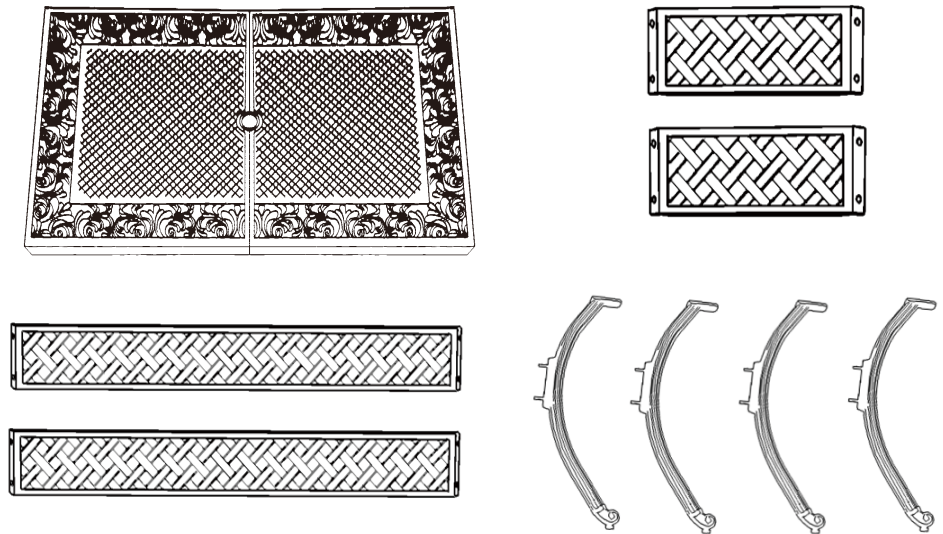

Unpack and place all parts on a clean soft surface.

Step 2

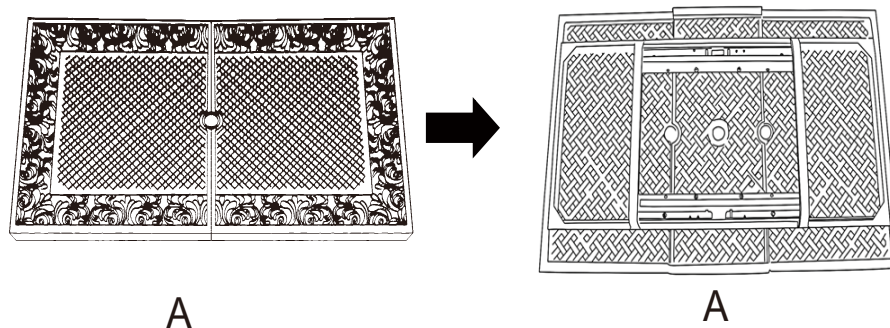

Turn the Table Top upside down on to a clean soft surface.
Caution: you may need 2 adults to turn the table top A upside down.

Step 3

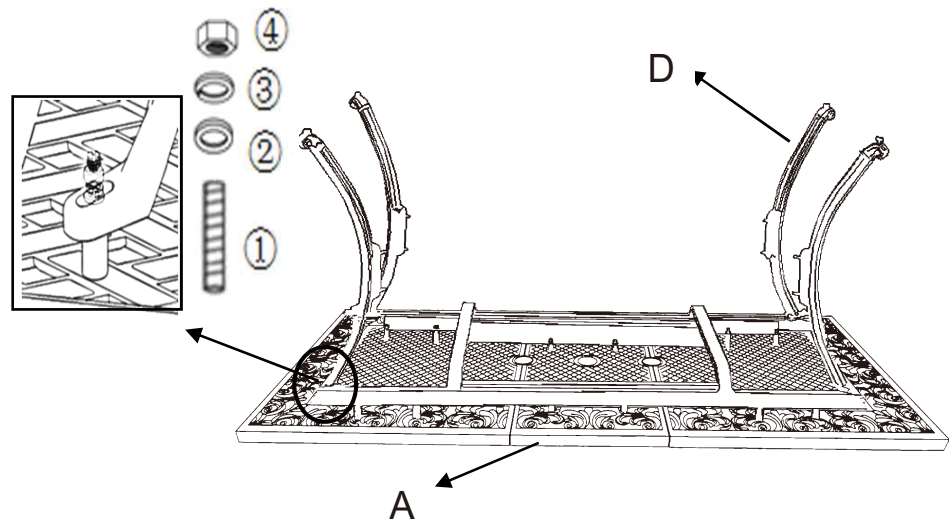

Tighten the Studs(①) first on the Table Top(A) by Screwdriver (⑥).

Then attach four Table Legs(D) to the mounting position on the Table Top(A) with Studs(①), Washers(②), Spring Washers(③) and Nuts(④) by Spanner(⑦).

Do Not Overtighten all nuts.

Step 4

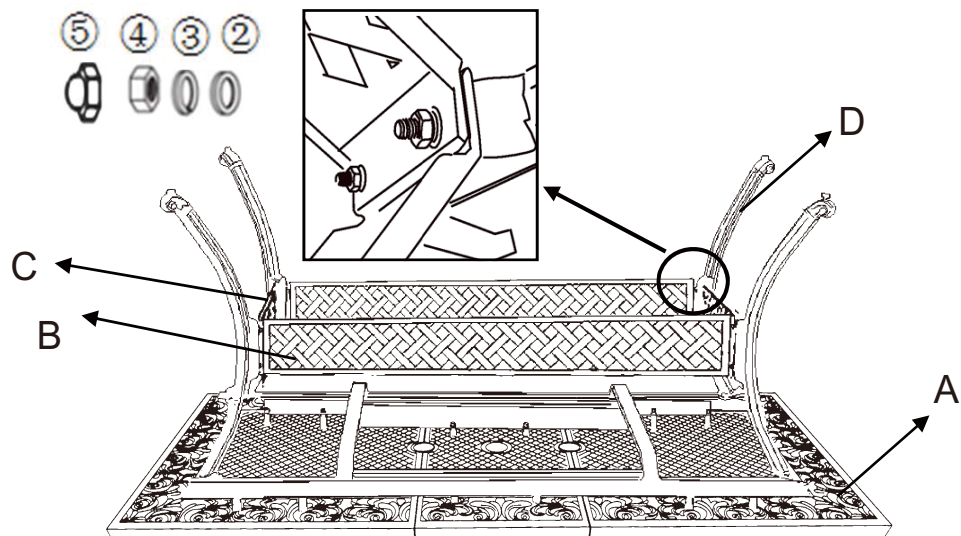

Attach four Leg Support to the mounting position with Washers(②), Spring Washers(③), Nuts(④) and the Nuts Cap (⑤) by Spanner(⑦).

Do Not Overtighten all nuts.

Step 5

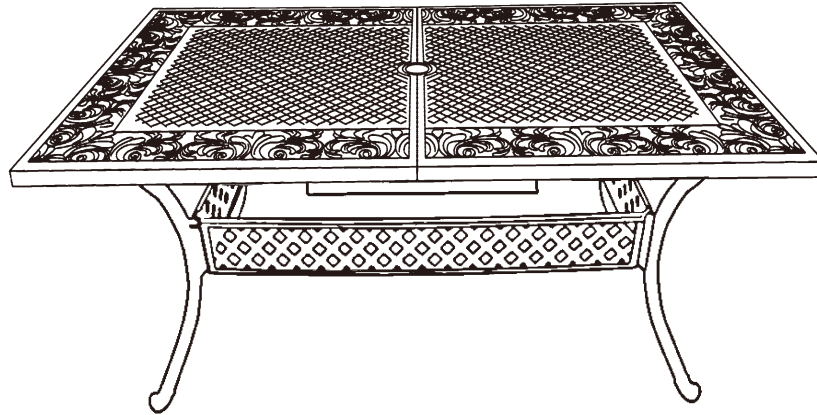

Turn the Table rightside up.
Adjust the pre-installed Leveller until the Table is level with the ground.
Then, proceed to tighten all Bolts and Nuts.
Your table is ready for use.

Step 6

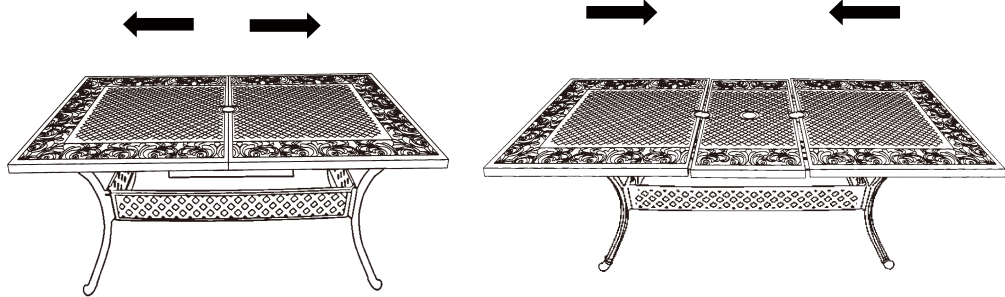

To expand the Table, pull the table top apart, then the central panels will go up, and then push the Table Top back to the center until the Table top is flush.

Step 7

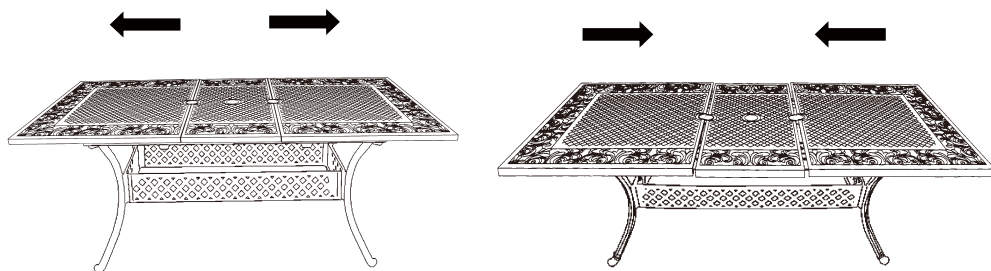

To shorten the Table, pull the table top apart, then the central panels will go down, and then push the Table Top back to the center until the Table top is flush.



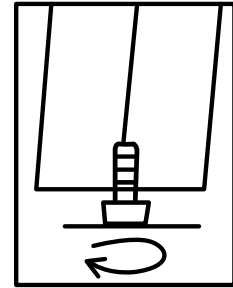
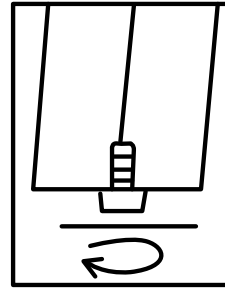
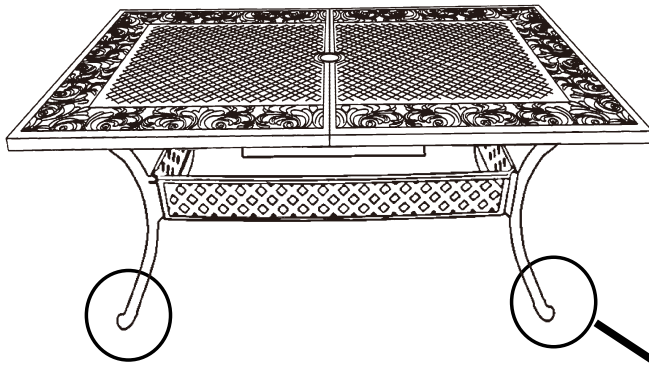















Step 8



Adjust Pre-installed
Levellers
height for balance

Adjust the Pre-installed Levellers at the base of the Legs using the Table is level with the ground.

Care & Maintenance

-   • Do not put hot items directly on furniture surface.
 -   • Do not clean furniture with harsh cleansers or polish.
 -   • To obtain the longest lifespan of your outdoor products, minimizing exposure to direct sunlight is recommended.
 -   • Children should not climb or jump on the furniture.
 -   • Do not write on furniture without a padded barrier to protect the surface.
 -   • To obtain the longest lifespan of your outdoor products, avoid extended and lengthy exposure to rain, snow, and direct sunshine. Whenever possible cover the product and /or place under patio or awnings.
 -   • Not for commercial use. For residential use only .
 -   • Stains may be removed with mild soap solution and damp cloth.
-
-   • Dust and pick-up spills using a clean, non-colored, lint-free cloth .