

User Manual

Parts List

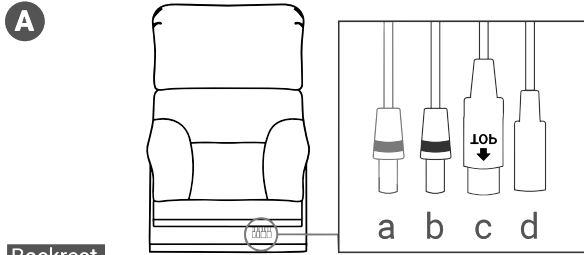

Backrest

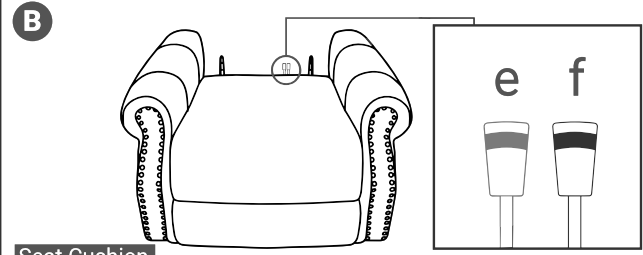

Seat Cushion

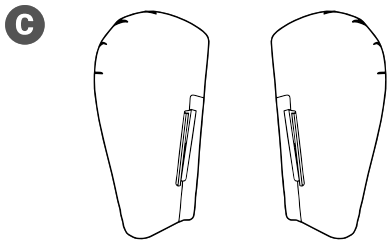

Back Armrest

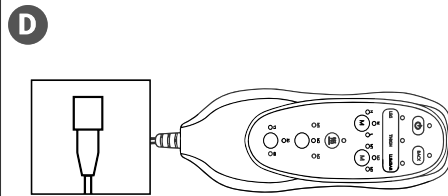

Massage Remote Control

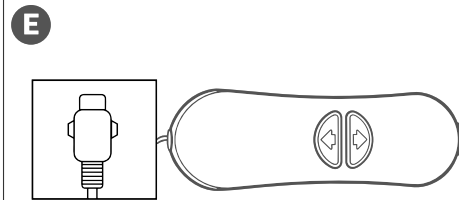

Electric Lifting Remote Control

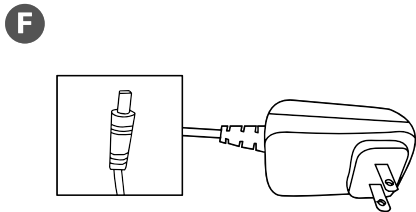

Power Adapter 1

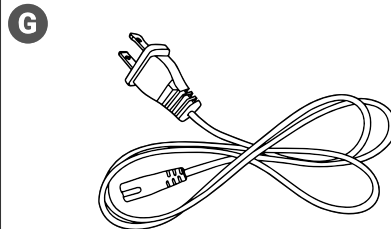

Power Cord

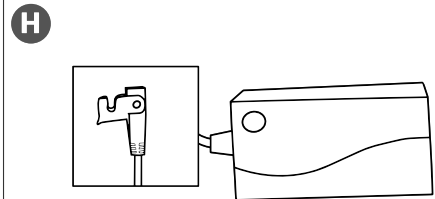

Power Adapter 2

Assembly Instructions

STEP 1

Secure the backrest to the buckles behind the seat cushion

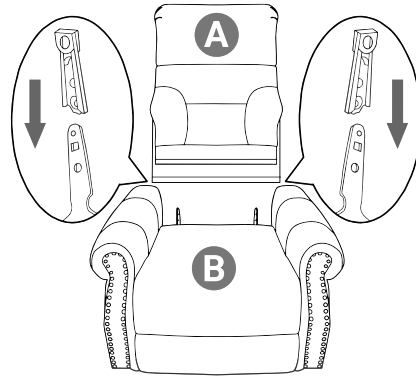

STEP 2

Fasten the backrest sides to the clips on both sides of the backrest

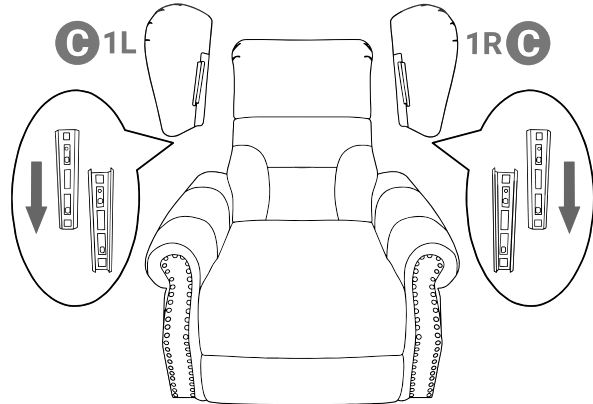

Assembly Instructions

STEP 3

Connect wires as per the diagram

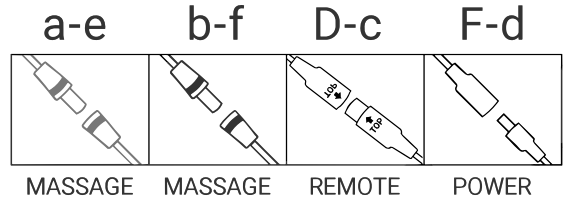
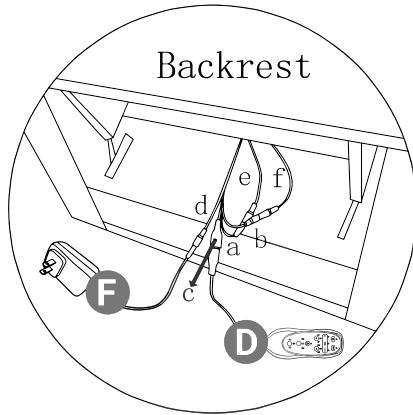

STEP 4

Connect wires as per the diagram

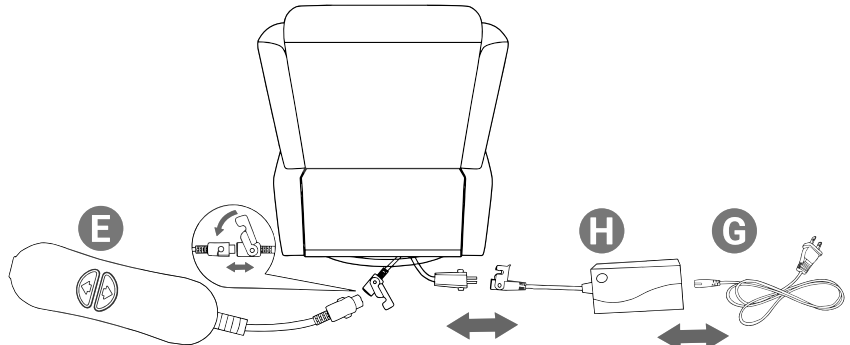

VOLTAGE PARAMETERS:

Voltage	AC110-240V DC 12V
Current	1A
Power	12W
Voltage Grade	Class III
Frequency	50-60Hz

PRODUCT FEATURES:

1. Heating massage and temperature three-gear
Adjustment:M1-M2-M3
2. Eight vibration motors
3. Three massage modes
4. Three massage intensities
5. Four massage zones, each zone can be operated individually
6. The default timing is 15, 30 and 60 minutes

Warning - Critical Safety Precautions

1. Before use, inspect the power cord and plug for damage. If the power cord is damaged, discontinue use immediately to avoid hazards and contact Culect.
2. Do not connect to power until the product is fully installed. Disconnect power before moving the product.
3. Avoid the risk of electric shock by never plugging or unplugging the power cord with wet hands.

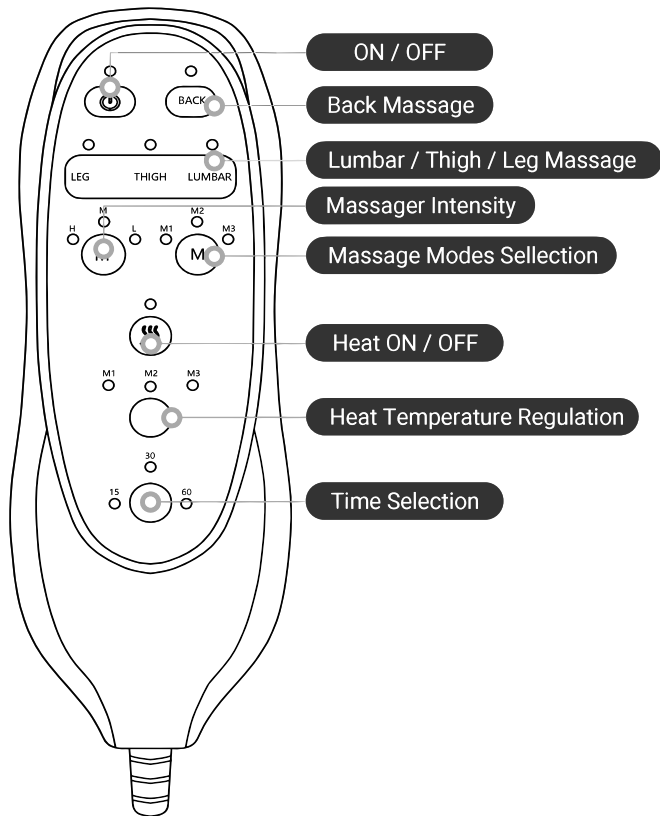

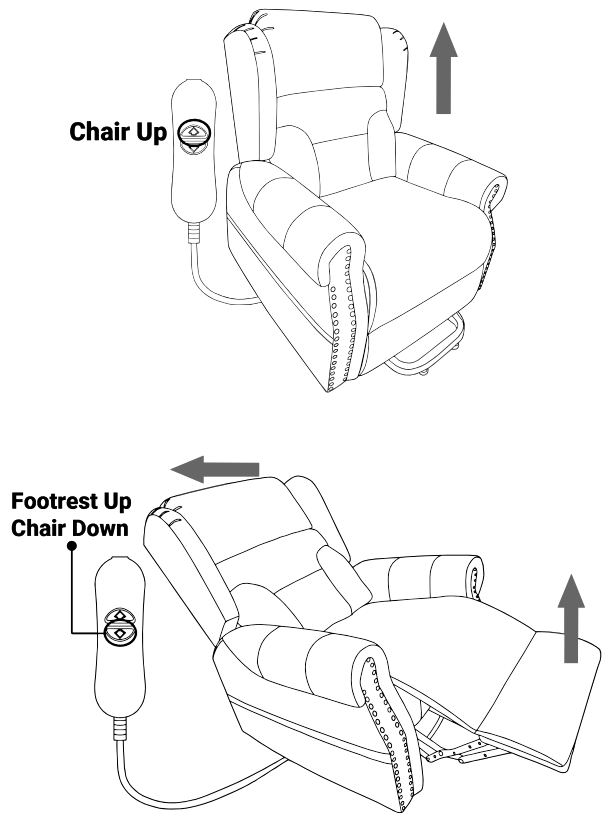
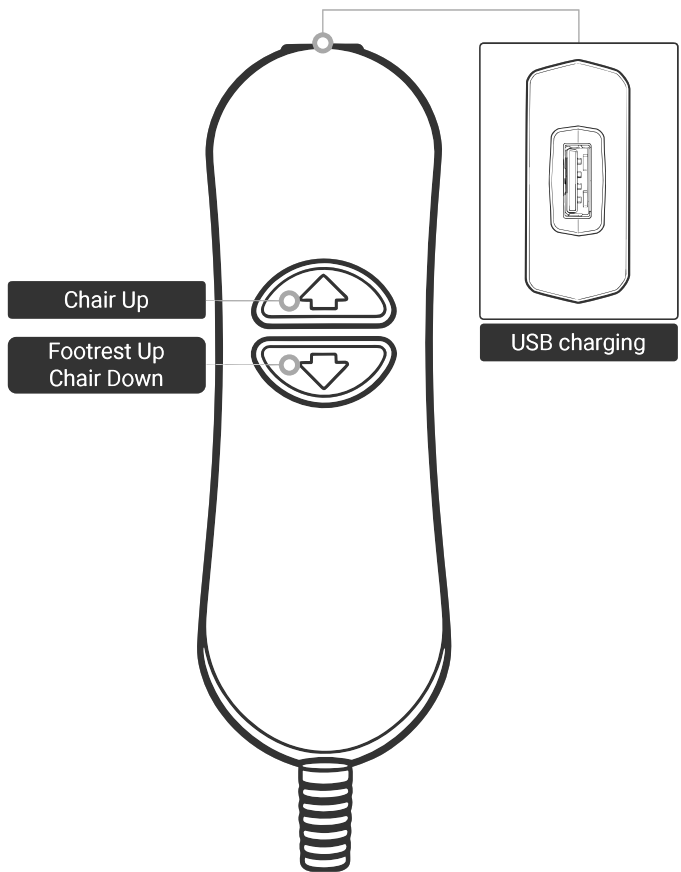

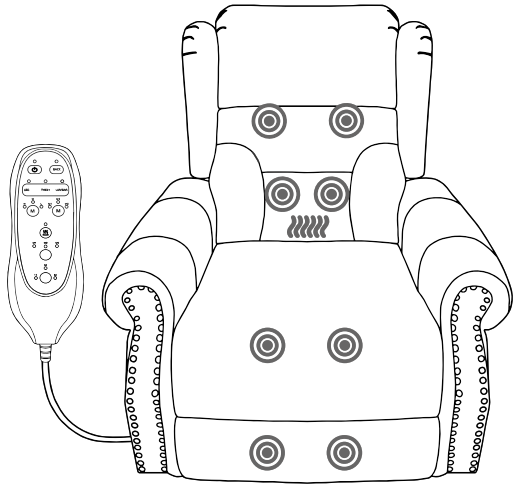

Cleaning Instructions

As the fabric cover is non-removable, gently wipe any soiled areas with a damp, soft cloth.

Special Notes

This product contains electrical cords/adapters/plugs. Avoid direct sunlight and prolonged use in high-humidity environments.

HOW TO USE

1. Insert the adapter jack into the socket on the back of the massage chair, then plug the adapter into a wall outlet.
2. Turn the unit on by pressing the 'POWER' button once-the LED will illuminate when powered on.
3. Turn on the massage for the zone you desire by pressing the 'BACK', 'LUMBAR', 'THIGH' or 'LEG' button. LED will illuminate the zone activated. To turn off a zone, press the button again.
4. To choose a massage mode, press the 'MODE' button. To change modes, press the 'MODE' button until the LED for the desired mode illuminates.
 - PULSE:** For deep tapping massage
 - PRESS:** Provides rapid tapping massage
 - WAVE:** For a gradual, side-to-side vibrating massage
5. Press the 'INTENSITY' button to change the massage intensity. The HIGH or LOW LED will illuminate for the intensity chosen.
 - NOTE:** Stop using immediately if you feel any discomfort or pain.
6. The massage chair includes an auto shut-off feature.
7. Do not use this chair continuously for more than 60 minutes.