

Owner's Manual



52" Dual Mount Ceiling Fan

5 BLADES

- Assembly & Installation
- Operation

CONGRATULATIONS!

You have chosen the best. Your new ceiling fan will provide you with many years of comfort and satisfaction.

TABLE OF CONTENTS

Safety Tips	2
Unpacking Your Fan	3
Tools and Materials Required	4
Electrical Outlet Box	4
Install Hanger Bracket	5
Installing the Fan	6
Electrical Connections	9
Blade Attaching	10
Install Light Kit	11
Operation	12
Trouble Shooting	13
Maintenance	14

TOOLS AND MATERIALS REQUIRED

- Phillips screw driver
- Blade screw driver
- Adjustable pliers or wrench
- Step Ladder
- Wire cutter
- Electrical tape



ELECTRICAL OUTLET BOX

- If there is an existing outlet box, ensure it is UL listed and clearly marked "Suitable for Fan Support". If not, it must be replaced with an approved one.
- Secure the outlet box (or make sure the existing box is secured) directly to the building structure. Use appropriate fasteners and building materials. Wood joist and outlet box must be able to support a minimum of 50 pounds.
- Figures 1, 2, and 3 are examples of different ways to mount the outlet box in different situations. A longer downrod may be required in sloped ceiling situations to maintain proper blade clearance.
- To hang the fan in locations where no ceiling joist is available, a hanger support bar may be required (Fig. 4).

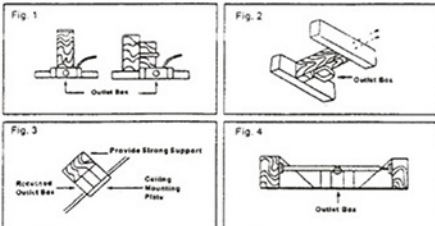

- 4 -

INSTALL HANGER BRACKET

- To avoid possible electrical shock, be sure electricity is turned off at the main power panel before wiring.
- All wiring must be in accordance with National and Local Electrical Codes, and the ceiling fan must be grounded as a precaution against possible electrical shock.
- Attach hanger bracket to outlet box using screws provided with the outlet box (Fig. 5). Install square rubber washers between bracket and outlet box to reduce vibration of metal to metal surfaces.

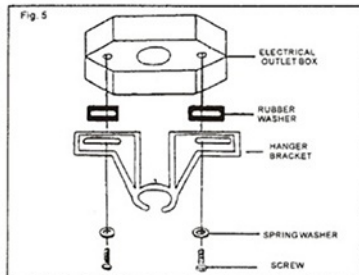

CAUTION: Electrical box must be wired to U. L. general use wall switch. To reduce the risk of injury, turn off power at wall switch or main fuse or circuit breaker before attempting installation or servicing.

WARNING: To avoid fire or shock, follow all wiring instructions carefully. Any electrical work not described in these instructions should be done or approved by a licensed electrician.

WARNING: To reduce the risk of fire, electric shock, or personal injury, mount to outlet box marked acceptable for fan support and use mounting screws provided with the outlet box. Most outlet boxes commonly used for the support of lighting fixtures are not acceptable for fan support and may need to be replaced. Consult a qualified electrician if in doubt.

- 5 -

SAFETY TIPS

- To avoid possible electric shock, turn off the electricity at the main fuse box or circuit panel before you begin the fan installation or before servicing the fan or installing accessories.
- Read all instructions and safety information carefully before installing your fan and save these instructions.
- Make sure all electrical connections comply with local codes or ordinances and the National Electrical Code. If you are unfamiliar with electric wiring, please use a qualified and licensed electrician.
- Make sure you have a location selected for your fan that allows clear space for the blades to rotate and at least seven (7) feet of clearance between the floor and the fan blade tips. The fan should be mounted at least thirty (30) inches from walls or other upright structures.
- WARNING:** The outlet box and ceiling support (just used) must be securely mounted, and capable of supporting at least 50 pounds. To reduce the risk of fire, electric shock or personal injury, mount to outlet box marked acceptable for fan support and use mounting screws provided with the outlet box. The box must be supported directly by the building structure.
- WARNING:** To reduce the risk of fire, electric shock or personal injury, mount to outlet box marked "acceptable for fan support" and use mounting screws provided with the outlet box. Most outlet boxes commonly used for the support of lighting fixtures are not acceptable for fan support and may need to be replaced. Consult a qualified electrician if in doubt.
- Electrical diagrams are for reference only. Light kits that are not packed with the fan must be U. L. listed and marked suitable for use with the model fan you are installing. Switches must be U. L. general use switches. Refer to the instructions packaged with the light kits and switches for proper assembly.
- After installation is complete, check that all connections are absolutely secure.
- After making electrical connections, spliced conductors should be turned upward and pushed carefully up into outlet box. The wires should be spread apart with the grounded conductor and the equipment-grounding conductor on one side of the outlet box.
- WARNING:** To reduce the risk of electrical shock and fire, do not use this fan with any solid-state fan speed control device, or thermostat.
- Do not operate the reverse switch until the fan has come to a complete stop.
- Do not insert anything into the fan blades while they are rotating.
- WARNING:** To reduce the risk of personal injury, do not bend the blade brackets (also referred to as "tangies") during assembly or after installation. Do not insert objects in the path of the blades.
- To avoid personal injury or damage to the fan and other items, be cautious when working around or cleaning the fan.
- Do not use water or detergents when cleaning the fan or fan blades. A dry dust cloth or lightly dampened cloth will be suitable for most cleaning.

NOTE: The important safety precautions and instructions appearing in this manual are not meant to cover all possible conditions and situations that may occur. It must be understood that common sense and caution are necessary factors in the installation and operation of the fan.

- 2 -

UNPACKING YOUR FAN

- Unpack your fan and check the contents. Do not discard the carton. If warranty replacement or repair is ever necessary, the fan should be returned in original packaging. Remove all parts and hardware. Do not lay motor housing on its side, the decorative casing may shift.
- Examine all parts. You should have the following:

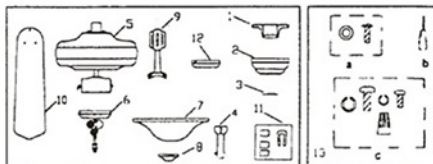

1. Hanger Bracket	1 piece	7. Glass Shade	1 piece
2. Canopy	1 piece	8. Decorative Cup	1 piece
3. Canopy Bottom Cover	1 piece	9. Blade Arm	1 set (5 pcs)
4. Downrod / Ball Assembly	1 set	10. Blade	1 set (5 pcs)
5. Fan Housing, Motor, and Switch Housing Assembly	1 set	11. Balancing Kit	1 bag
6. Light Kit	1 set	12. Extra Switch Cap	1 piece

13. Parts Pack Containing:			
a) Blade Screws and Fibre Washers	15 sets		
Extra Blade Screw and Fibre Washer	1 set		
b) Pull Chain / Fob	2 sets		
c) Hanger Bracket Hardware and Extra Screw			
Wire Nuts	3 pcs		
Extra Blade Arm Screw and Spring Washer	1 set		
Extra Yoke Screws and Spring Washer For Huger Style Use	3 sets		

Note: Blade Arm Screws and Spring Washers (10 sets) are already in fan motor.

- 3 -

INSTALLING THE FAN

SELECT TYPE OF INSTALLATION

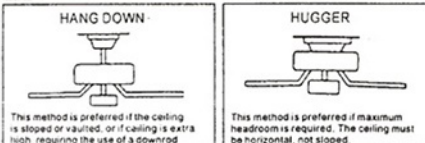

WARNING: The fan must be hung with at least 7" of clearance from floor to blades.

HANG DOWN STYLE

- Slide the canopy on the downrod (Fig. 6). Thread the power leads from the fan through the canopy, and downrod. Take extra care not to pull power wires damage and loose connections could result from any abnormal pressure on these wires. Set downrod into yoke. Rotate until the holes match. Be careful not to damage wiring. Insert connector pin through the holes (See Fig. 6A, 6B). Secure the pin by inserting the stop pin through the connector pin.

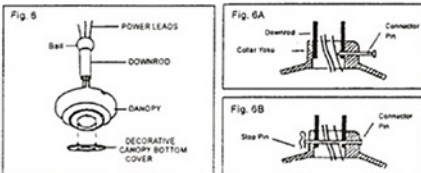

WARNING: Do not force connector pin through downrod. Use of force could cause damage to wires inside. Make sure the stop pin is properly engaged to prevent it from falling out. If failure to properly install locking pin as noted could result in fan loosening and possibly falling.

- 6 -

- Tighten the two downrod setscrews. Some models have locknuts for the setscrew to ensure the setscrews fully seat against the downrod. It is necessary to back off the locknut until it contacts the setscrew head prior to tightening the setscrew. When setscrew is tightened against downrod, locknut should then be tightened against connector yoke. Repeat for both (Fig. 7).

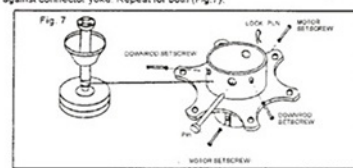

- Tighten motor setscrew. Check the strength of this connection (pre-tightened at factory) by holding the motor housing in position, and turning the downrod counter clockwise. If this connection slips, re-tighten motor setscrew and locknut. Follow the same procedure and mentioned above for downrod setscrews.
- Install ball in hanger bracket opening. The ball opposite of the hanger bracket opening should fit in ball opening (Fig. 8).

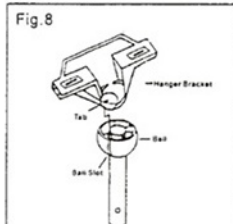

- Make wire connections. (Refer to section titled "Electrical Connections")
- Slide canopy up and fasten to hanger bracket with the 4 screws provided.
- WARNING:** To avoid damaging the blade arms and blades, do not install either until fan is fastened to ceiling. To avoid motor shift, handle fan by downrod or switch housing only.

- 7 -

HUGGER STYLE

1. Fasten the canopy directly to the top of the fan motor housing with the 3 screws provided (The downrod, ball and canopy bottom cover, and yoke cover are not used for this installation). (Fig. 9A) If a metal ring washer with 3 holes is provided, use it to install canopy.
2. Hang the canopy (with the fan motor housing attached) from the tab on the hanger bracket (Fig. 9B). This will allow you to make the electrical connections without having to touch the fan up.
3. Make the wire connections described in the "Electrical Connections".
4. Put 2 screws in the hanger bracket, leaving them partially out (Fig. 9C).
5. Place the canopy up on the hanger bracket by inserting the slotted opening of the canopy on the screws (Fig. 9D).
6. Insert the remaining screws through the remaining canopy holes and tighten all 4 screws.

WARNING: Failure to completely tighten the screws in step 1 could result in an loosening and possible falling.

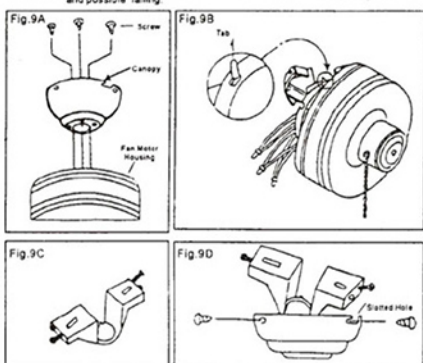

- 8 -

OPERATION

1. Restore electrical power by turning on the electricity at the main fuse box.
2. Turn on the wall switch.
3. Your fan has two controls on the switch housing, and one control on light kit.

SPEED CONTROL	LIGHT CONTROL		DIRECTION CONTROL
Put Chain Switch (lug gently)	Put Chain Switch (lug gently)		Reverse Slide Switch (up and down)
1 - High	1 - On	Up for upward air flow to circulate air upward	
2 - Medium	2 - Off	Down for downward air flow for a cooling effect.	
3 - Low			
4 - Off			

Turn the fan off and set the blades stop before changing setting of reverse slide switch. Your ceiling fan is a sensible choice to cool as well as help you warm your living area. You will have a reduction in both heating and cooling costs by regular use of your fan. In summer, put the reverse switch in the forward position so air is blown down, producing a cooling breeze. In winter, reverse the fan so an upward air flow will push warm air off the ceiling and balance the temperature in the room. In winter, run the fan at a lower speed than in the summer.

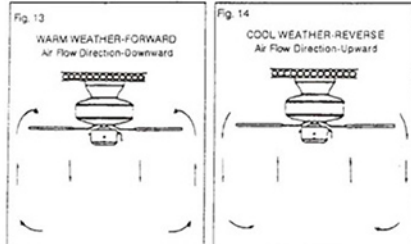

- 12 -

ELECTRICAL CONNECTIONS

1. Four wires are connected to the top of the fan.
 - Black: "Hot" Power for the Light
 - Blue: "Hot" Power for the fan and light
 - White: "Common" For the fan and light
 - Green: Ground Wire
2. If fan and light are to be connected to the same circuit, the black and blue wires should be connected together to the black wire in the ceiling using a wire nut to make the connection. If a light kit is not being installed the blue wire should be left unconnected.
3. The white wire from the fan should be connected to the white wire in the ceiling, using a wire nut to make the connection.
4. The green wire from the fan should be connected to the ground wire in the ceiling, using a wire nut to make the connection.
5. Tuck your completed wiring back up into the electrical box.

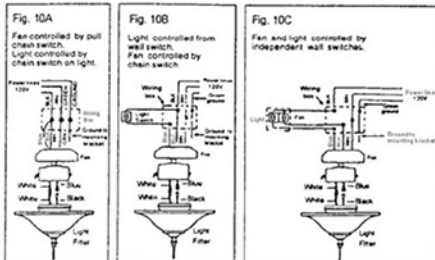

- WARNING:** To avoid possible electrical shock, be sure electricity is turned off at the main fuse box before wiring.
- NOTE:** If you are not sure the electrical box and fan are grounded, contact a licensed electrician for advice. They must be grounded for safe operation.
- WARNING:** Each wire nut (wire connectors) supplied with this fan is designed to accept up to one 12 gauge house wire and two wire from the fan. If you have larger than 12 gauge house wiring or more than one house wire, to connect to the fan wiring, consult an electrician for the proper size wire nut to use.
- WARNING:** Check to see that all connections are tight, and that no bare wire is visible at the wire nuts.

- 9 -

TROUBLE SHOOTING

FAN WILL NOT START:

1. Check all fuses or circuit breakers. Replace if missing.
2. Turn off electrical power and check all wire connections to fan and in switch housing.
3. Make sure pull chain switch is on, and reverse slide switch is up or down-not in the middle.

FAN IS NOISY:

1. Use of standard light rheostat or continuously variable fan speed wall control will always cause harmonic distortions, or a humming noise. Many fan motors do not work quietly with solid state variable controls. If a quiet wall control is desired, use only 3-speed UL approved wall controls.
2. Always allow a few days "break in" time for any new fan at medium or high speed. Try to diagnose the exact location of the noise by listening carefully from several sides. (Blades, Motor, Light kit, etc.) Fan noise can come from a light kit.
3. Make sure all screws in the fan assembly and light kit are tight and properly threaded. If not, back out and retighten. Tighten these screws at least once a year because they may loosen slowly over time and cause a clicking noise.
4. Make sure the light kit is securely fastened to the fan, and all glass screws are finger tightened only. Do not tighten with pliers or a screw driver.
5. Make sure mounting bracket is installed snugly to junction box.
6. Make sure wire nuts in switch housing for canopy are not rattling against each other or against wall of housing. Wrap with electrical tape if necessary.
7. Make sure the canopy is not touching the ceiling.
8. Assure that the screws fastening blade arm to motor are tight and the lock washers provided for that purpose have been used.
9. Make sure all light bulbs are fully screwed in.

FAN TURNS BUT DOES NOT MOVE MUCH AIR:

1. The fan may be running in reverse, so air is directed upward.
2. The room may contain items that obstruct the air flow.
3. The fan may be too small for size of the room.

FAN SHAKES OR WOBBLER:

1. A small amount of movement is considered acceptable and should not be considered a defect.
2. Make sure mounting bracket is tight at junction box/ceiling with not movement at all. Tighten screws if necessary.
3. Make sure all screws holding the blades to the blade arm and blade arm to motor are tight. Make sure light kit/glass screws are tight.
4. Some fan movement is normal. However, interchanging an adjacent (side-by-side) blade pair may redistribute the weight and result in smoother operation.
5. Most fan wobble problems are caused when blade levels are unequal. Check this level by selecting a point on the ceiling above the top of one of the blades. Measure this distance as shown in Figure 15. Measurements should always be within 1/8". Rotate the fan until the next blade is positioned for measurement. Repeat for each blade.
6. If a blade balancing kit is provided, use it if needed. If none is in canon, call Customer Service at 1-800-255-4446 and request a balancing kit.

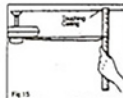

- 13 -

BLADE ATTACHMENT

1. Place fiber washer on screw. Insert this assembly through the blade and start the screw into the blade arm. Repeat this procedure without tightening the screw until all 3 screws have been started into the blade arm (Fig. 11).
2. Tighten each screw starting with center screw.
3. Fasten blade assembly to motor with provided screws and metal lock washers. Repeat procedure for remaining blades (Fig. 11B).

NOTE: Failure to follow above procedure could result in fan wobble.

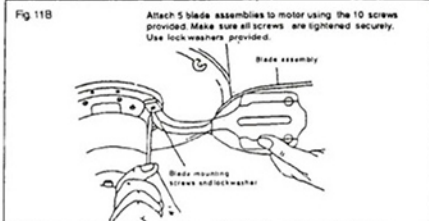
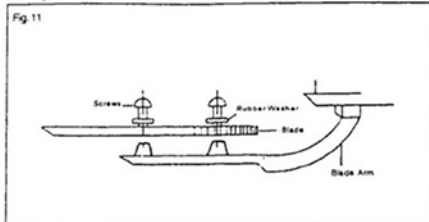

- 10 -

INSTALLING LIGHT KIT

1. Locate two single wires in the switch housing (white and blue labeled "for light").
2. Connect them to the light kit wires. Make sure they fasten together tightly (Fig. 11).
3. Secure all splices with electrical tape to prevent connectors from vibrating loose during fan operation.
4. Install two (40 watt max.) light bulbs (not provided).
5. Install the glass back onto light kit.
6. Restore power and your light kit is ready for operation.
7. If the light kit does not work, turn off the electricity and lower either the canopy or decorative housing on your ceiling fan. Make sure the blue wire is connected to black household wire. (Please refer to the electrical connections section in this manual.)

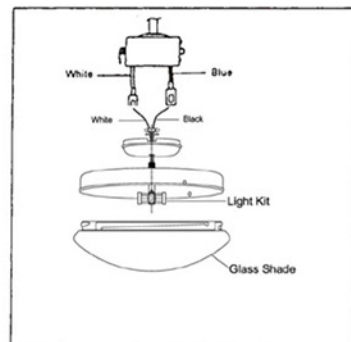

- 11 -

MAINTENANCE

1. The fan's natural movements may cause some connections to work loose. A clicking or rattling noise is a certain sign of loosening screws. Check the support connections, brackets, and blade attachments twice a year, and tighten all screws as necessary. Make sure all screws attaching the glass to the filter on the light kit are finger tight. Do not use a screw driver or pliers to tighten glass screws.
2. Clean your fan periodically. Use only a cloth dampened with a mild detergent solution. Never use solvents. Dust with a soft cloth or brush. Metal finishes are finished with a lacquer to prevent tarnishing.
3. You will never need to oil your fan. Its permanently sealed bearings will provide silent trouble free operation for many years.
4. Make sure the power is turned off at the main fuse or circuit panel before you attempt any repairs.

- 14 -