

# ALEKO

INSTALLATION & INSTRUCTIONS

INSTRUCTIONS



W5700

RV AWNING

# CONTENTS

Package Components.....	3
Preparation.....	5
Installation.....	6
Motor limit position adjustment.....	11
Operation.....	12
Maintenance.....	15

## WARNING



Please read and insure you understood this instruction before install, adjust, service and maintain the awnings. This awning must be installed and serviced by qualified person.

Please be sure to take good care of this manual for daily maintenance !

# Package Components

□ W5700

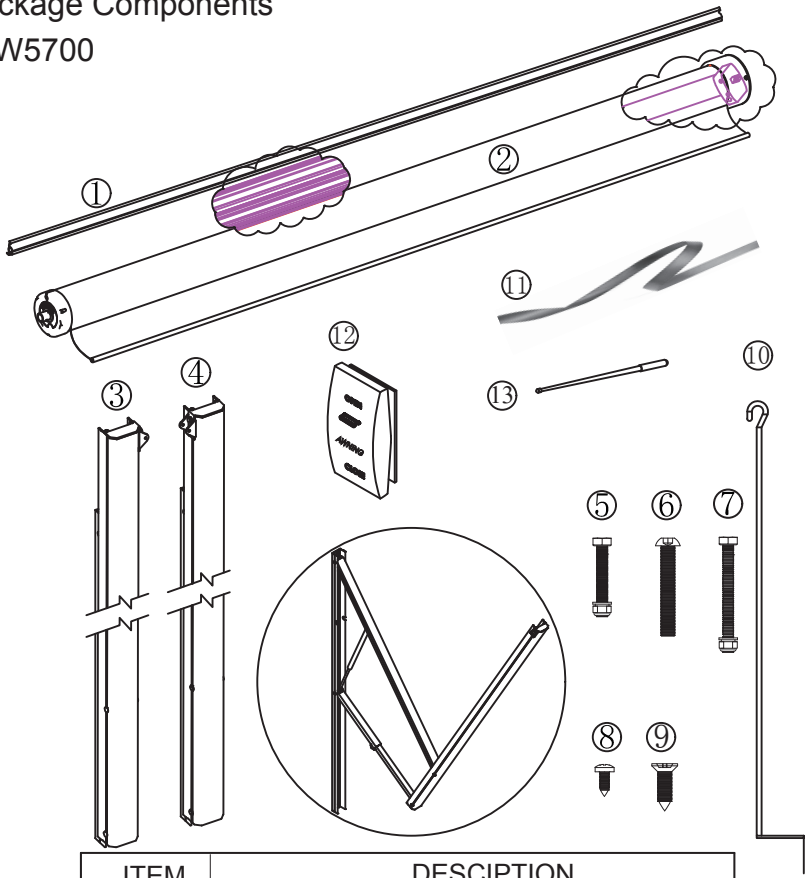

ITEM	DESCRIPTION
1	Fabric lock rail
2	Fabric tube
3	Left arm
4	Right arm
5	M5x40 Hex head screws
6	M6x50 Screw
7	M6x60 Hex head screws
8	Ø4.2x13.5 Self-tapping screw
9	M6X16 Screw
10	Hand crank
11	belt
12	Switch
13	Adjustable rod

# Package Components

□ W5700C

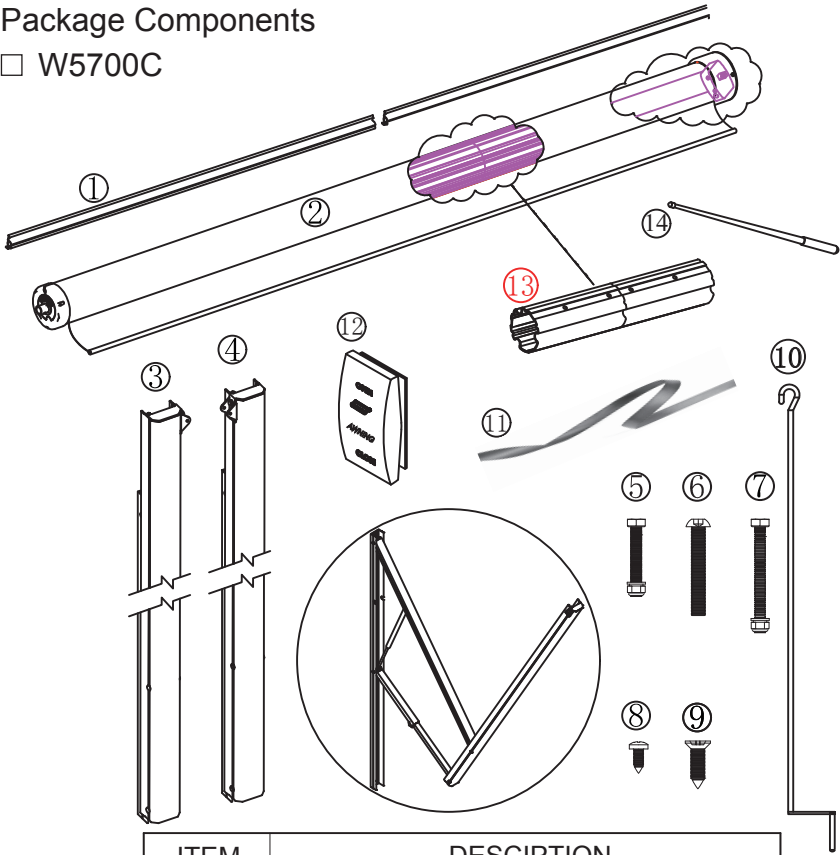

ITEM	DESCRIPTION
1	Fabric lock rail
2	Fabric tube
3	Left arm
4	Right arm
5	M5x40 Hex head screws
6	M6x50 Screw
7	M6x60 Hex head screws
8	Ø4.2x13.5 Self-tapping screw
9	M6X16 Screw
10	Hand crank
11	belt
12	Switch
13	Fabric tube connector
14	Adjustable rod

## Preparation

1. Please open the package, and check all the accessories according to the part list are complete.
2. Please confirm that install tools are ready, such as hand drill, tape measure, screwdriver, marker pen and Ladders Etc.
3. According to your purchased awning size, mark the 6 fixation points for installation.  
(The six fixation-points positions should be calculated according to the calculation formula bellow)

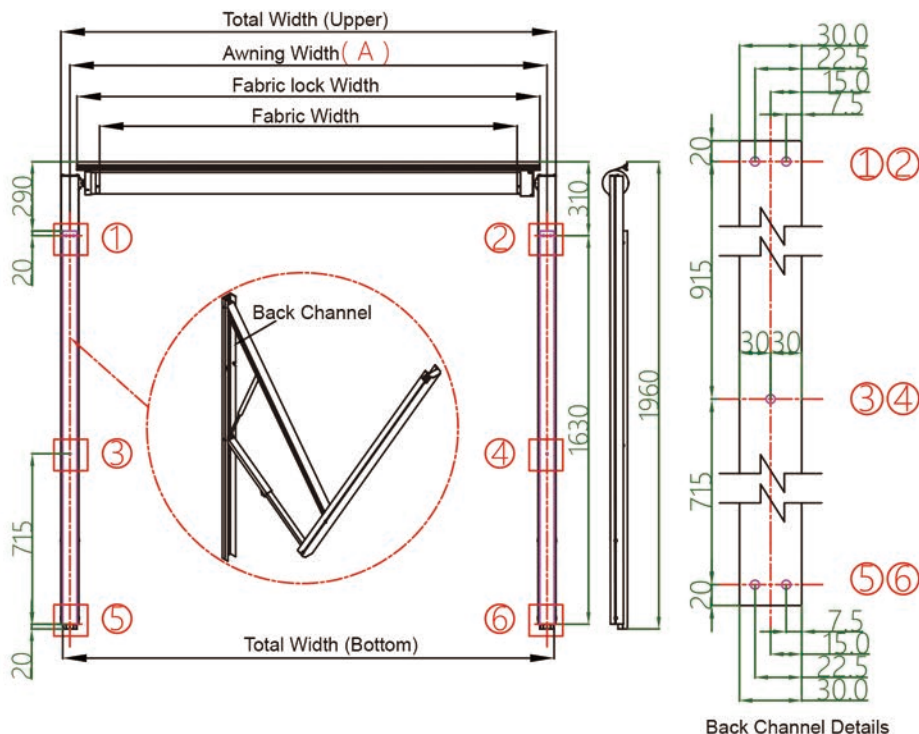

- Note:** The 6 mounting points must be in the position of RV body which have strong bearing force  
 Installation points ① & ②, ③ & ④, ⑤ & ⑥ must be in the same horizontal position  
 Installation points ① & ⑤, ② & ⑥ must be in the same vertical position

### Metric size

Measurement position sheet							Unit : m	
Awning Width (A)	2.5	3.0	3.5	4.0	4.5	5.0	5.5	6.0
Total Width (Upper)	A+0.075							
Fabric lock Width	A-0.13							
Fabric Width	A-0.25							
Total Width (Bottom)	A+0.06							
Folded arm Height	1.96							
Extension (Max.)	2.5							

# Imperial Size

Measurement position sheet														Unit:ft/in	
Awning Width (A)	8'	9'	10'	11'	12'	13'	14'	15'	16'	17'	18'	19'	20'	21'	
Total Width (Upper)	A+2.95''														
Fabric lock Width	A-5.12''														
Fabric Width	A-9.84''														
Total Width (Bottom)	A+2.36''														
Folded arm Height	77.17''														
Extension (Max.)	8''														

## REMARK:

“A”=Awning width (Left arm center to right arm center)

Please check the above measurement sheet carefully, and calculate the correct installation position accordingly.

## Installation Steps

### Step.1

1. Please open the plastic protection sleeve from two arms first. (**Attention:** This is gas piston arm, it will open automatically when the sleeve is released, when you take out sleeve, please firmly grasp the arms and observe your surroundings, to avoid personal injury and product damage), see Pic.1

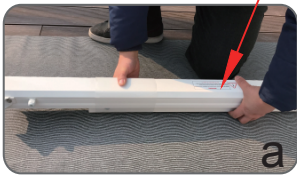

protect sleeve cover

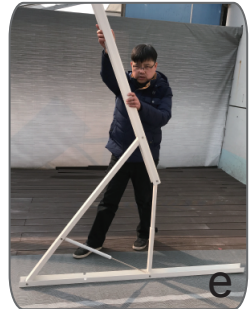
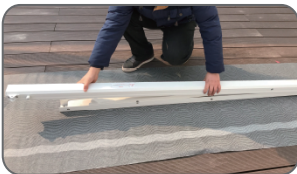

2. Install the open arm in the pre-marked installation position, as shown in Pic.2 & Pic.3-a. Please put the belt behind the arm before installation, see Pic. 3-b.

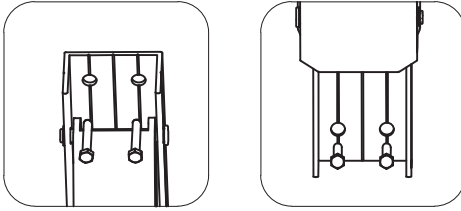

Pic.2



Pic.3

3. After arms are fixed, please use offered belt tie up the left & right arm, avoiding private injure see pic.3-c

### ATTENTION !

If you choose our modular type(W5700C)  
Please connect the fabric tube first before  
you start Step 2

### 1. Connect the fabric tube

Please find the fabric roller tube (right side cover with a motor and wire, left side only have a cover, and the rest is the middle tube). And take out the tube connector from the roller tube then connect all tubes with M6X16 Screws piece by piece. see bellow pics.( please be sure all three sides tube fix tight, or the tube will be curved easily during operation).

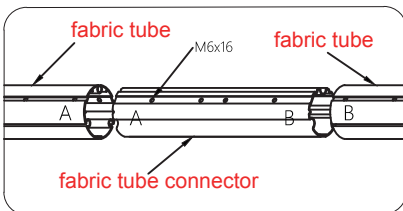

a

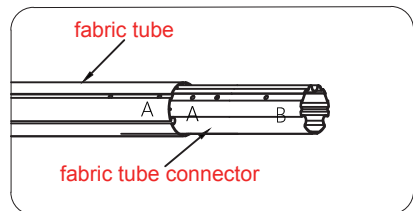

b

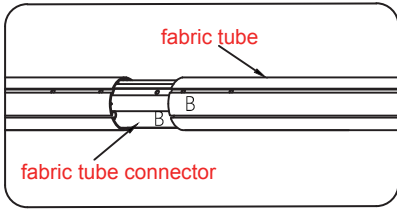

c

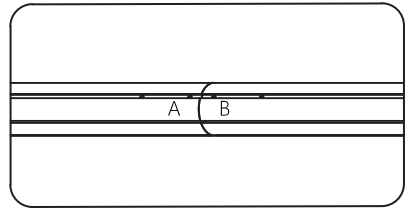

d

## 2. Roller tube fabric fixation

- Insert the poly cord into valance fabric slop. See Pic.a
- Finished step "a" and slide the valance fabric into groove No.1. See Pic.b
- Pull the fabric to hole No.2 direction.
- Fold the fabric and then insert it to punched hole No.2
- Slide the poly cord to hole NO.2 and then fix roller tube fabric well.
- Rolling the fabric towards the roller tube clockwise direction( Groove NO.1 direction).

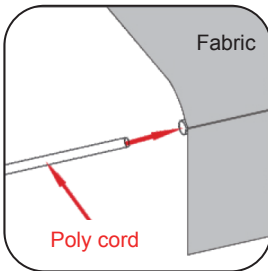

a

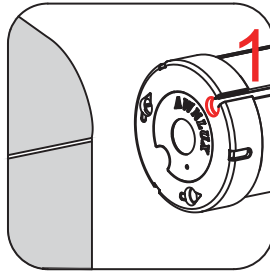

b

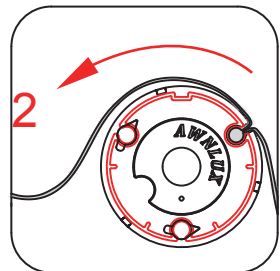

c

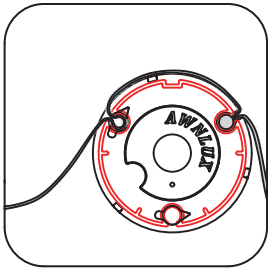

d

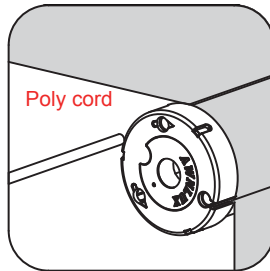

e

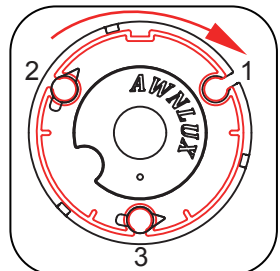

f

## Step.2

Please fix the fabric lock rail on the wall of the car, see pic.4

**Remark:** After installing, please use structural glue on the back of fabric lock rail in case of water leakage

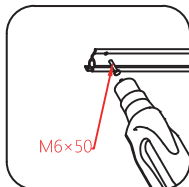

Pic.4



### Step.3

#### Fabric fixation on Car

Find out the poly cord and get across fabric loop, then put the fabric into the fabric lock rail, see Pic.5

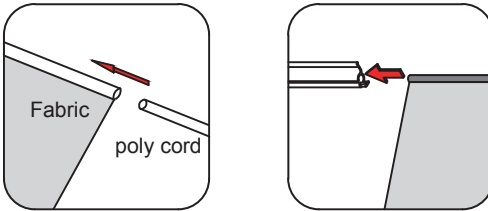

Pic.5

### Step.4

Please install the roller tube on the left arm and right arm , see PIC.6

**Remark:** Please Be sure the connect motor part is on right arm.

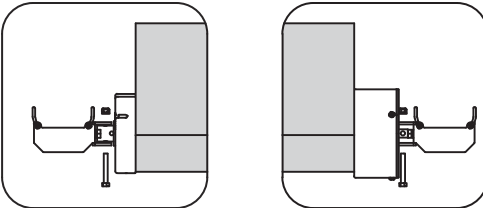

Pic.6

### Step.5

After installing the roller tubes, loosen the ropes on the arms (the arms will be slightly opened but not completely opened), in this case, temporarily connect the motor, switch and power supply, operate method as Step9.

Adjust the motor limit position when power on, operate method Step10.

### Step.6

After Done Step 5, please open and close the awning normally, and ensure if the fabric is plan & smooth. If not, please pull the fabric to adjust it well. After you confirm fabric is ok, please use the self-tapping screws to fix fabric on both end of fabric locking rail,see Pic.7

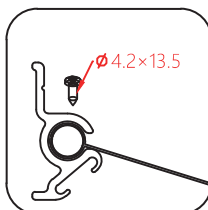

Pic.7

## Step.7

After adjust motor limit position, Please open the awning completely, and remove the temporary wires. Please Connect the power cord of the motor from the hole on the right side arm, then connect with cable which put inside of the arm, and then hide the connector in the protection shell, See Pic.8.

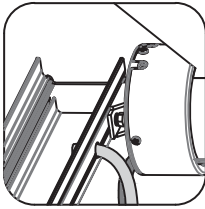

motor cable

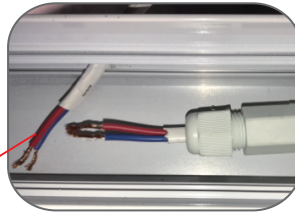

Pic.8

## Step.8

Connect the motor to the car power cord and hide the connector in the protection shell to prevent water intake. See Pic.9

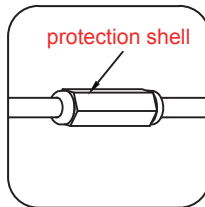
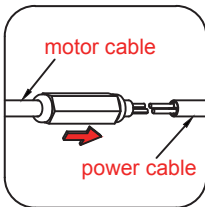

Pic.9

## Step.9

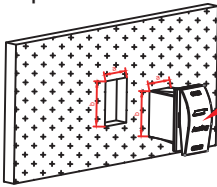

Pic.10

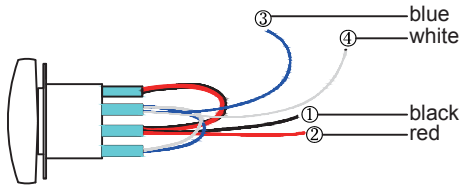

## Switch installation

Please open the hole in the car wall according to the switch bottom shell size.

## Wiring instructions

### 1. Without LED light

- ① wiring (+) & ② wiring (-) for the power cord, please connect with the car power supply.
- ③ wiring & ④ wiring are for motor, please connect with motor cable (motor cable no "+", "-" differences)

### 2. With LED light stripe

- ① wiring (+) & ② wiring (-) for the power cord, please connect with the car power supply.
- ③ wiring & ④ wiring are the parallel wires for controlling the motor and LED light, please connect with motor and led light cable (motor and LED light cable need parallel connection)

## Step.10

Motor (DC 12V) limit position adjustment.

**Motor limit position:** To control awning close or open max. position by adjusting the winding number of the motor's positive and negative direction

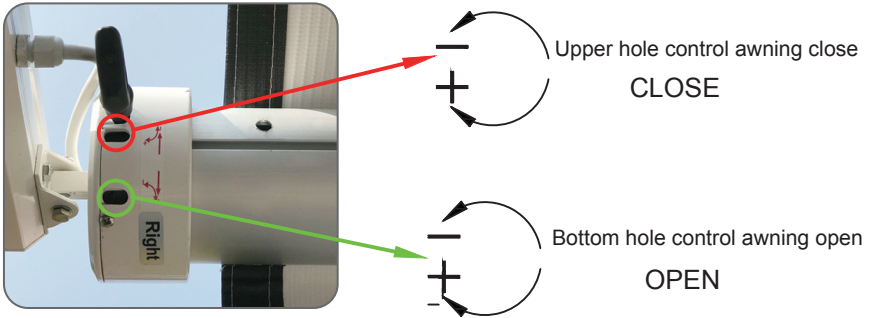

Pic.11

### Remark:

In the following adjustment processing, please always pay attention to the state of awning, not too much adjustment motor, only adjust slowly (0.5-1 turns every time), otherwise the motor will completely lose its function.

## Max.OPEN Position

1. Turn the switch to "OPEN" position , as shown in Pic.12  
The awning begins to open;
2. When the awning can not be fully opened, insert the adjusting rod into the bottom hole of motor, and adjust it to "+" direction until it is completely open.
3. When the awning is fully open but the motor is still running, insert the adjusting rod into bottom hole of motor and adjust to the "-" direction until the motor stop running.

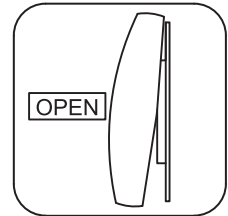

Pic.12



Pic.13

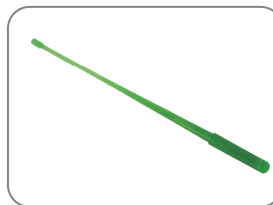

## Completely Close Adjustment

1. Completely Close Adjustment
2. Turn the switch to the CLOSE position, as shown in Pic.14,  
the awning starts to close;
3. When the awning can not be fully closed, insert the adjusting rod into upper hole of the motor, and adjust to "-" direction. Until awning completely close
4. When the awning is completely closed ,but the motor is still running, insert the adjusting rod into upper hole of the motor and adjust to "+" direction until the motor stop running.

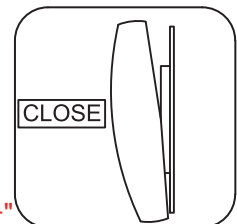

Pic.14

# How to operate awning

## OPEN AWNING

**Attention:** Maintain a horizontal distance of at least 2.5m between fully open awning and any permanent object. Do NOT face awning toward permanent objects that may interfere with awning operation. Failure to obey this caution could result in injury.

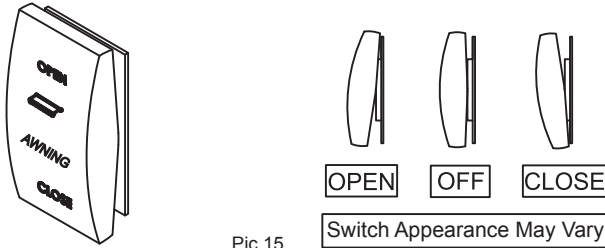

Pic.15

## Switch instructions

1. With LED light

OPEN: Open the awning

OFF: 1. Awning will stop when button is released no matter how far awning extend/retracted

2. Turn off the LED lights

COSE: close awning

2. Without LED light:

OPEN: Open the awning

OFF: .Awning will stop when button is released no matter how far awning extend/retracted

COSE: close awning

## Adjust Awning Pitch (Optional)

The FRTA (fabric roller tube assembly) will be lower than RV's awning rail when hardware is fully extended. This pitch (slope) will help accommodate water run off. If a steeper pitch is desired, the FRTA must be lowered

### To lower FRTA:

1. With awning fully extended, loosen adjustable knob on adjustable pitch arm assembly (bottom arm).

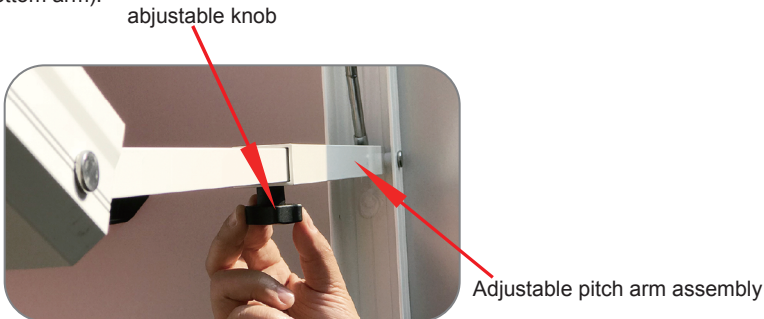

Pic.16

2. Keep CLEAR of openings around adjustable pitch arm assembly while adjusting awning pitch (slope). Adjustable pitch arm assembly (bottom arm) will telescope. Failure to obey this caution could result in injury. Do NOT allow corner of entry door to contact awning fabric. Otherwise, abrading wear or tearing of awning fabric could be occurred. Pull top arm assembly down to lower FRTA to desired height. While holding top arm assembly in place, tighten adjustable knob to set pitch (slope).

top arm assembly

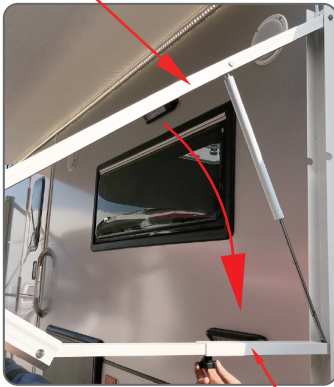

Adjust-able pitch arm assembly

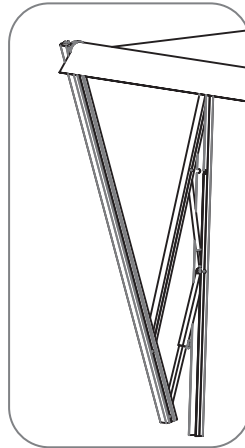

Pic.17

3. Do NOT allow water to pool or snow to accumulate on awning fabric. Or the awning will become unstable, and could bend or collapse. When it has heavy rain or snow is expected, place awning in stowed (closed) position. Lowering one arm assembly into water shed position (to create a slope from other arm assembly) will allow water run-off during light rain.

- a. With awning fully extended, verify top arm assembly nearest entry door is fully extended, and that adjustable knob is tightened.
- b. Pull top arm assembly (farthest from entry door) down until awning slopes approximately 15° maximum from other arm assembly. After adjusting the tilt angle you want, lock the knob to use the awning 15° degrees (with the horizontal angle).



Pic.18

## 4. Close Awning

- Loosen adjustable knobs to allow awning to reset to original position. Then lightly tighten knobs on both arm assemblies to help ensure rattlefree travel. Pull top arm assembly down to verify knob is NOT too tight. Adjustable pitch arm assembly MUST still slide as normal. see Pic.15
- Keep CLEAR of arm assemblies while closing awning. Arm assemblies will [fold / close] against back channel. Failure to obey this warning could result in death or serious injury.
- Press and hold toggle to retract (ON) position on (fixed/wired) remote awning switch until awning is fully closed. Awning will automatically stop when button is released no matter how far awning is extended/retracted.

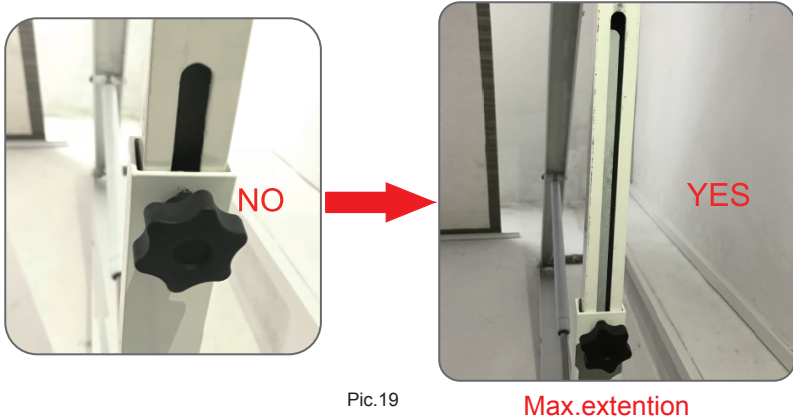

## 5. Emergency function-Manual control

- In particular case, if there is a power cut or motor damage, but the awning needs to be used, the manual control system can be worked. Each awning is equipped with a motor crank at the motor right side, Use our handle crank to hook the black crank and turn it clockwise or anti-clockwise to close or open awning
- Note that there should be no object to block the awning when it closed or opened. If the awning is blocked and the manual function continues, it will be damaged, which is not covered by the warranty.

**Remarks:** Manual control just an emergency function, please do not use this function when motorized function on.



## ATTENTION

Failure to obey the following notices could damage product or property!

### 1. Precautions: Failure to obey the following notices could damage product or property

- a. Do NOT use insecticides or other sprays near awning fabric. These could cause stains, and could adversely affect fabric's ability to repel water.
- b. Do NOT expose awning to adverse environmental conditions, corrosive agents, or other harmful conditions.
- c. Do NOT allow corner of entry door to contact awning fabric. Otherwise, premature wear or tearing of awning fabric could occur.
- d. NEVER close awning (for storage) when wet. The combination of moisture and dirt could result in mildew, discoloration, and stains. If it is necessary to roll up awning (temporarily) while it's wet, make sure you roll it out and let it dry (as soon as conditions allow) before rolling it up again.
- e. Do NOT allow dirt, leaves, or other debris to accumulate on awning, which could cause abrasion and stains. Mildew could grow on dirt and organic debris causing permanent discoloration, stains, and odors to awning fabric.
- f. Do NOT use strong chemicals or abrasives to clean parts. To prevent damage to the surface of the protective layer, neutral detergent can be used.

### 2. Fabric Care & maintenance:

Vinyl fabric offers the advantage of durability and water resistance. Wrinkling may be more noticeable when retracted, and after prolonged periods of stowage (rolled up). In warm weather, open it up for a period of time to minimize the wrinkling. Leave awning open during warm weather to minimize the wrinkling over time.

- a. To clean the fabric  
Do NOT use abrasive or cor-rosive cleaners, mildew removers, or hard bristle brushes on awning fabric. Liberally drench open awning fabric with cleaning solution. Close awning, let it soak for 10 minutes, then open awning again. Remove solution COMPLETELY from awning fabric. Bleach will degrade awning fabric if NOT completely rinsed off. Thoroughly hose off top and bottom of fabric with clean water.
- b. To repair a pinhole, or if a spot of coating flakes off from top layer of vinyl fabric  
Apply a very small dab of VLP (Vinyl Liquid Patch) on tip of cotton swab. Gently roll cotton swab around pinhole. The VLP will melt the coating (on fabric) and that will quickly fill in pinhole and blend with all colored vinyls. NEVER close (roll up) awning when vinyl liquid patch is wet. Otherwise, damage to other parts of awning fabric (melting through layers) will occur. Allow VLP to dry thoroughly before stowing (rolling up) awning.



W20180130EN