

■ ASSEMBLY INSTRUCTIONS:

STEP 1:

Remove & discard the red plastic cap covering the tip of the gas spring:

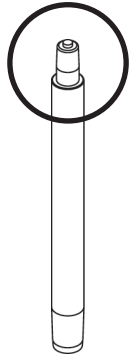

STEP 2:

Insert the gas spring (C) into the base (D). Once aligned correctly, press down firmly

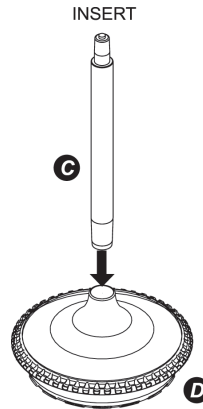

STEP 3:

Connect the Plastic Collar (B) to the Seat (A) by resting the Seat on the cushion and firmly pressing the Plastic Tube against the seat.

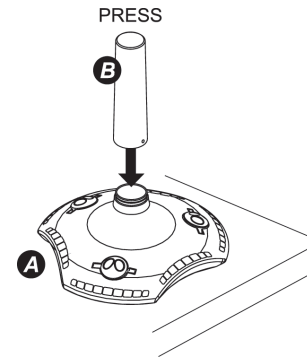

STEP 4:

Gently slide the seat onto the gas spring. Once aligned properly, press down firmly on the seat.

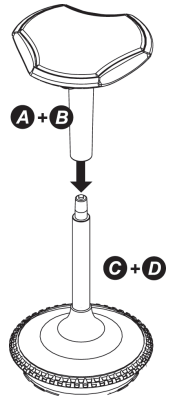

WARNING! The red plastic cap must be removed before use. Failure to remove it will make Wobble Stool malfunction.

■ OPERATING INSTRUCTIONS:

1. To raise the seat, gently press any 1 of the 3 underseat buttons.

2. To lower the seat: Gently press any 1 of the 3 underseat buttons and simultaneously press down on the seat (or sit on the seat).

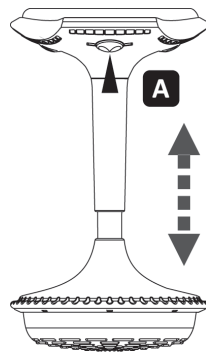

TIP! If the seat does not raise easily:

1. Be sure the red plastic cap on top of the gas spring has been removed.
2. If Wobble Stool is assembled correctly, add additional pressure to the seat by pushing down or sitting on it to secure the connection for proper use.

■ SITTING INSTRUCTIONS:

1. Wobble Stool's base is unstable. Wobble Stool rocks, tilts, tips and the seat swivels 360°. It is not a stationary chair. Extreme care must be used when sitting on the Wobble Stool.

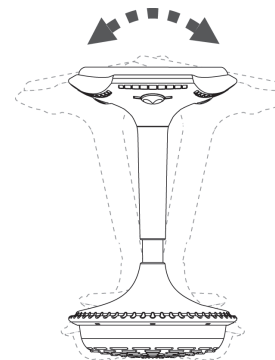

2. Only sit on Wobble Stool if both of your feet are planted firmly on the ground supporting your entire bodyweight.

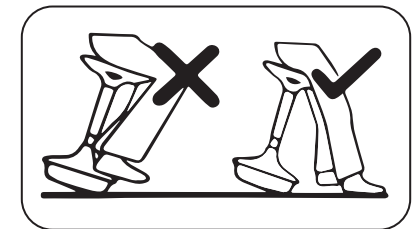

WARNING! DO NOT LEAN BACK. To reduce fall risk, do not tip Wobble Stool past vertical.
WARNING! Not for use by children.
WARNING! Do not use with only 1 foot or no feet on the ground.