











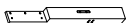

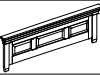





# ASSEMBLY INSTRUCTION

## DESCRIPTION: Queen Decorative Panel Headboard / Panel Footboard & Bed Rails

Thank you for purchasing this quality product. Be sure to check all packing material carefully for small Hardware which may have come loose inside the carton during shipment. Identify and count all Hardware and compare with the Hardware List Below.

PARTS LIST			
No.	Description		Qty.
①	Headboard Panel		1 Pc
②	LSF Leg		1 Pc
③	RSF Leg		1 Pc
④	Bottom Rail		1 Pc
⑤	Panel Footboard		1 Pc
⑥	Slats		4 Pcs
⑦	Slat Support		4 Pcs
⑧	Bed Rails		2 Pcs

⑨			
ASSEMBLY HARDWARE PACK OF HEADBOARD			
No.	Description	Hardware	Qty.
Ⓐ	JCBC Screw $\varnothing 1/4"$ x 45mm		14 Pcs
Ⓑ	Spring Washer $\varnothing 1/4"$		14 Pcs
Ⓒ	Flat Washer $\varnothing 1/4"$ x 19mm x 2mm		14 Pcs
Ⓓ	Allen Key M4		1 Pc
⑩			
ASSEMBLY HARDWARE PACK OF RAILS			
Ⓔ	Hanger Bolt $\varnothing 5/16"$ x $3*1/2"$		8 Pcs
Ⓕ	Hexagon Nut $\varnothing 5/16"$		8 Pcs
Ⓖ	Spring Washer $\varnothing 5/16"$		8 Pcs
Ⓗ	Flat Washer $\varnothing 5/16"$ x 14mm x 1mm		8 Pcs
Ⓚ	Wrench 12mm		1 Pc
⑪			
ASSEMBLY HARDWARE PACK OF FOOTBOARD			
Ⓛ	Screw M4 x 32mm		8 Pcs

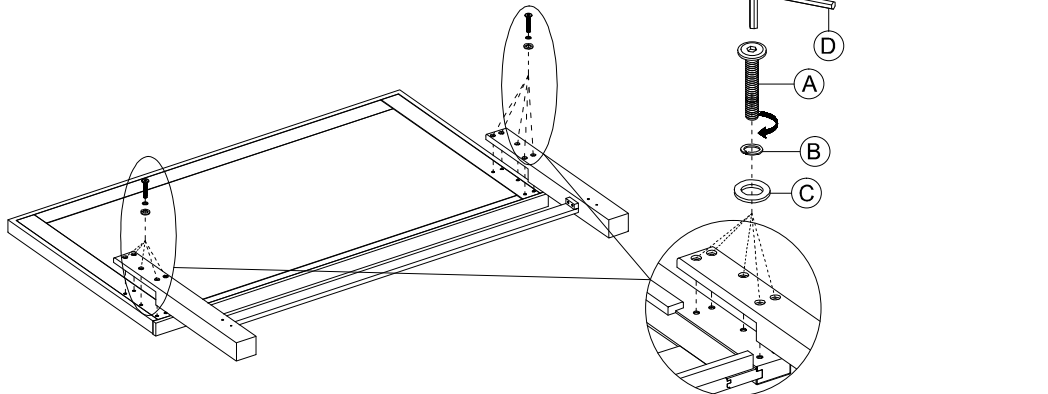
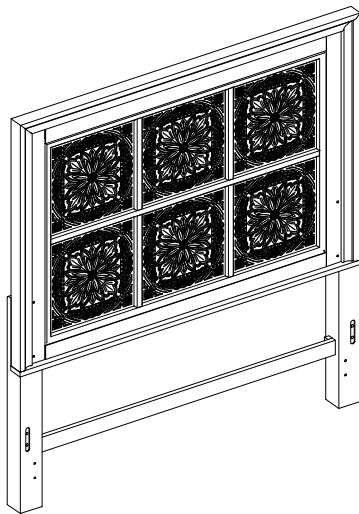

# ASSEMBLY INSTRUCTION

DESCRIPTION: Queen Decorative Panel Headboard /  
Panel Footboard & Bed Rails

