

# ASSEMBLY INSTRUCTIONS

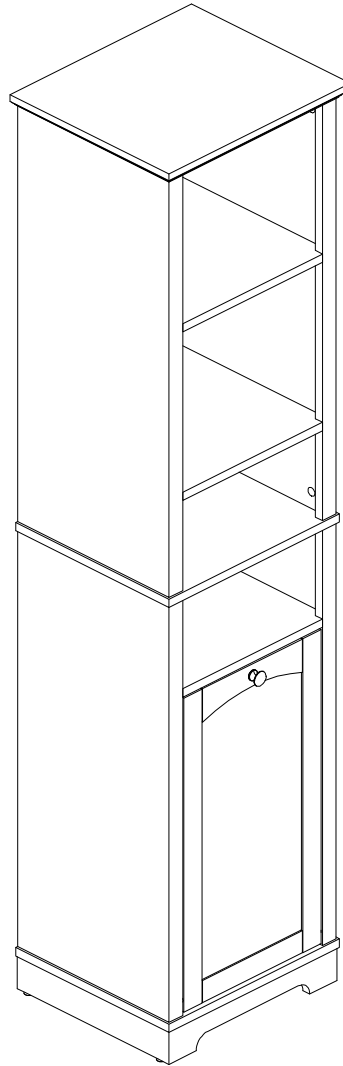

## Notice:

1. Follow the installation instructions. Please confirm all accessories are preset before installation.
2. Do not fully tighten the screws during initial assembly. Fully tighten screws only once all pieces which are correctly assembled.
3. If you encounter any problems during installation, please contact our customer service.
4. Please unbox the item from the side with an open-label and put a carpet on the floor to avoid scratching it.

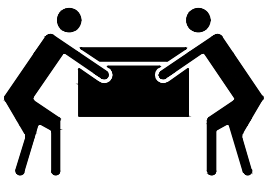

Recommended installers:2

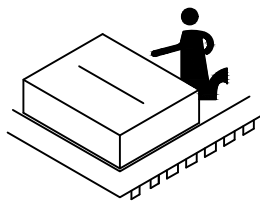

Put a carpet on the floor  
before unpacking

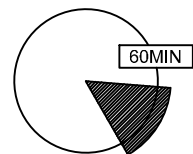

Estimate installation time:  
60minutes





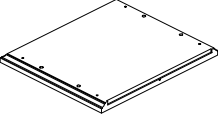
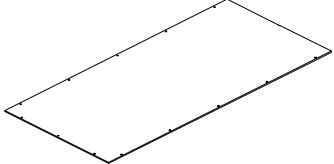
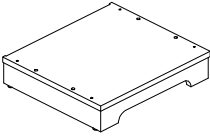
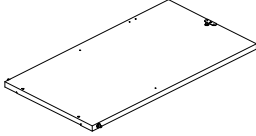
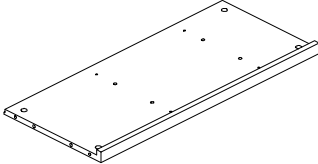
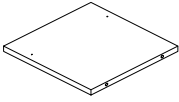
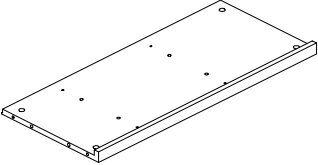
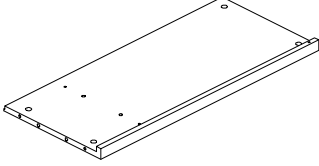
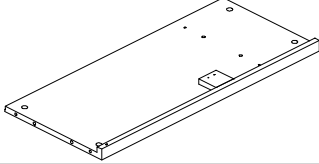
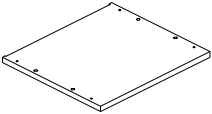
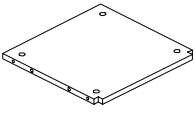
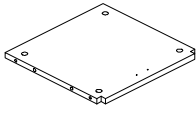

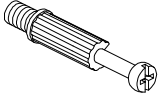
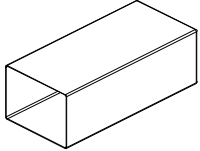
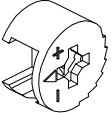

# ASSEMBLY INSTRUCTIONS

## PART LIST

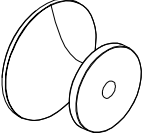
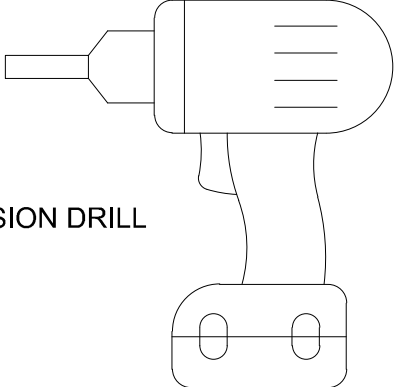
Item no.	Reference Image	Qty	Item no.	Reference Image	Qty
(A)		X1	(J)		X2
(B)		X1	(K)		X1
(C)		X1	(L)		X1
(D)		X1			
(E)		X1			
(F)		X1			
(G)		X1			
(H)		X2			
(I)		X1			

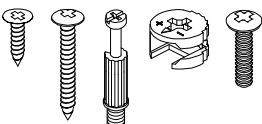
# ASSEMBLY INSTRUCTIONS

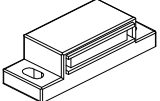
## HARDWARE LIST

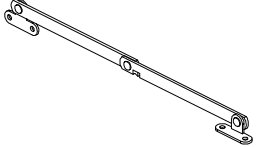
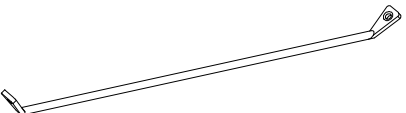
Item no.	Reference Image	Qty	Item	Reference Image	Qty
1		X30+3	11		X1
2		X30+3	12		X1
3		X1	<p><b>The following tools are needed. But not included.</b></p>  <p>PERCUSSION DRILL</p>  <p>SCREW DRIVER</p> 		
4	 Ø5/32"x3/4"	X1			
5	 Ø8x30mm	X28+2			
6		X1			
7	 Ø6xØ3x14 mm	X8			
8	 Ø6.5xØ3x15 mm	X29+2			
9		X1			
10		X2			

# ASSEMBLY INSTRUCTIONS

---

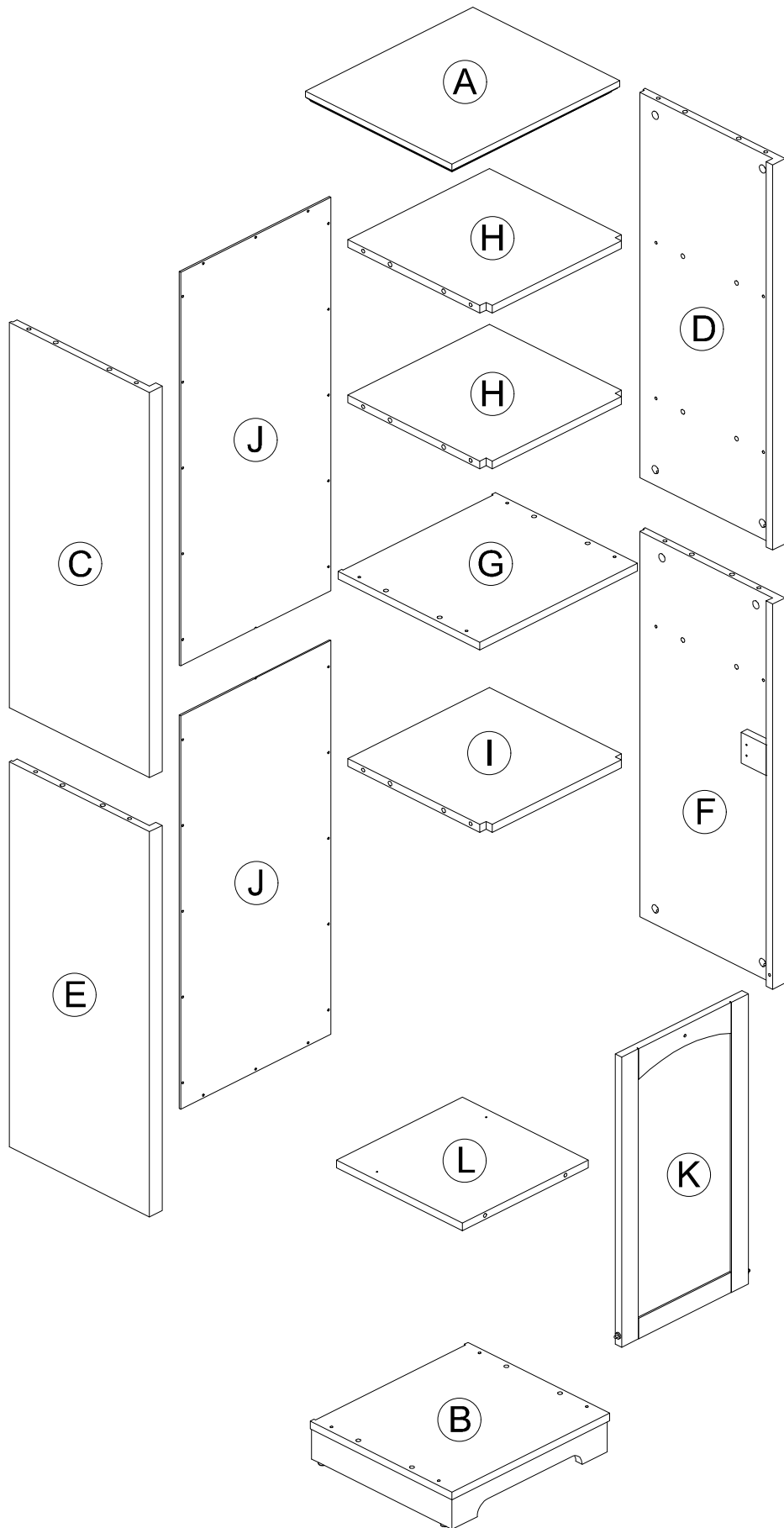

# ASSEMBLY INSTRUCTIONS

1

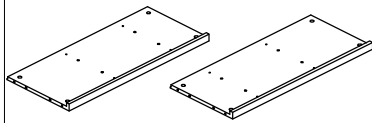

C 1pc

D 1pc

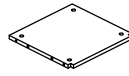

H 2pc

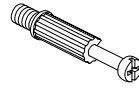

1 8pc



2 8pc



5 8pc

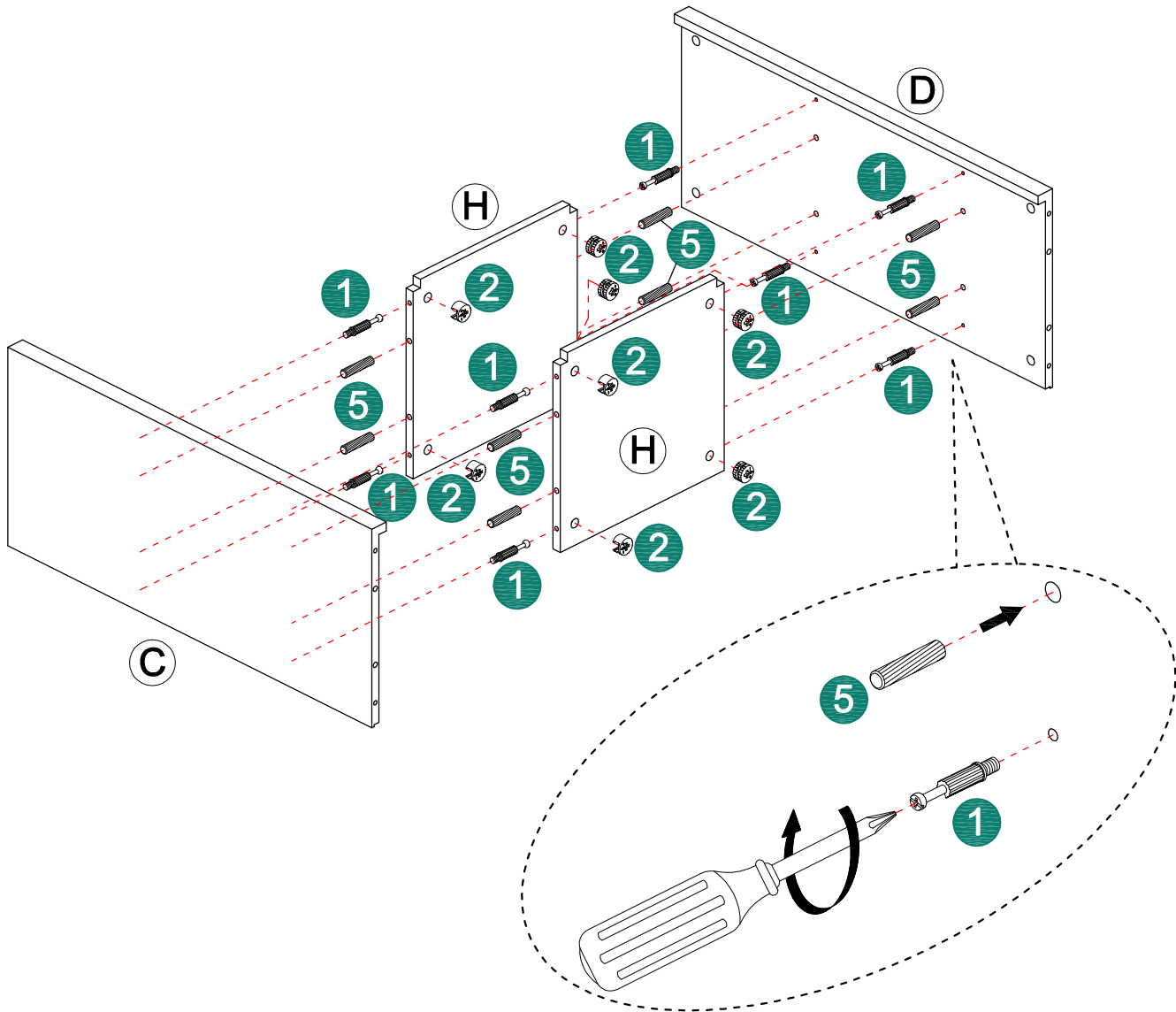
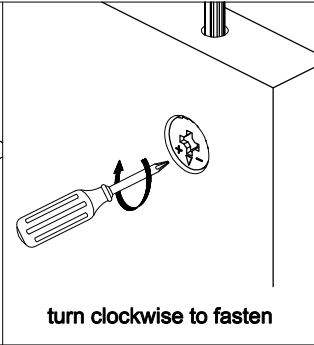
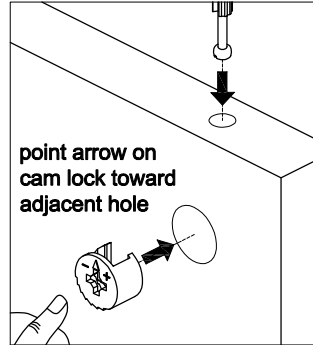

# ASSEMBLY INSTRUCTIONS

2

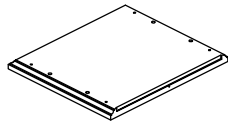

A 1pc

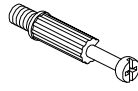

1 4pc



2 4pc

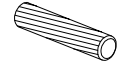

5 4pc

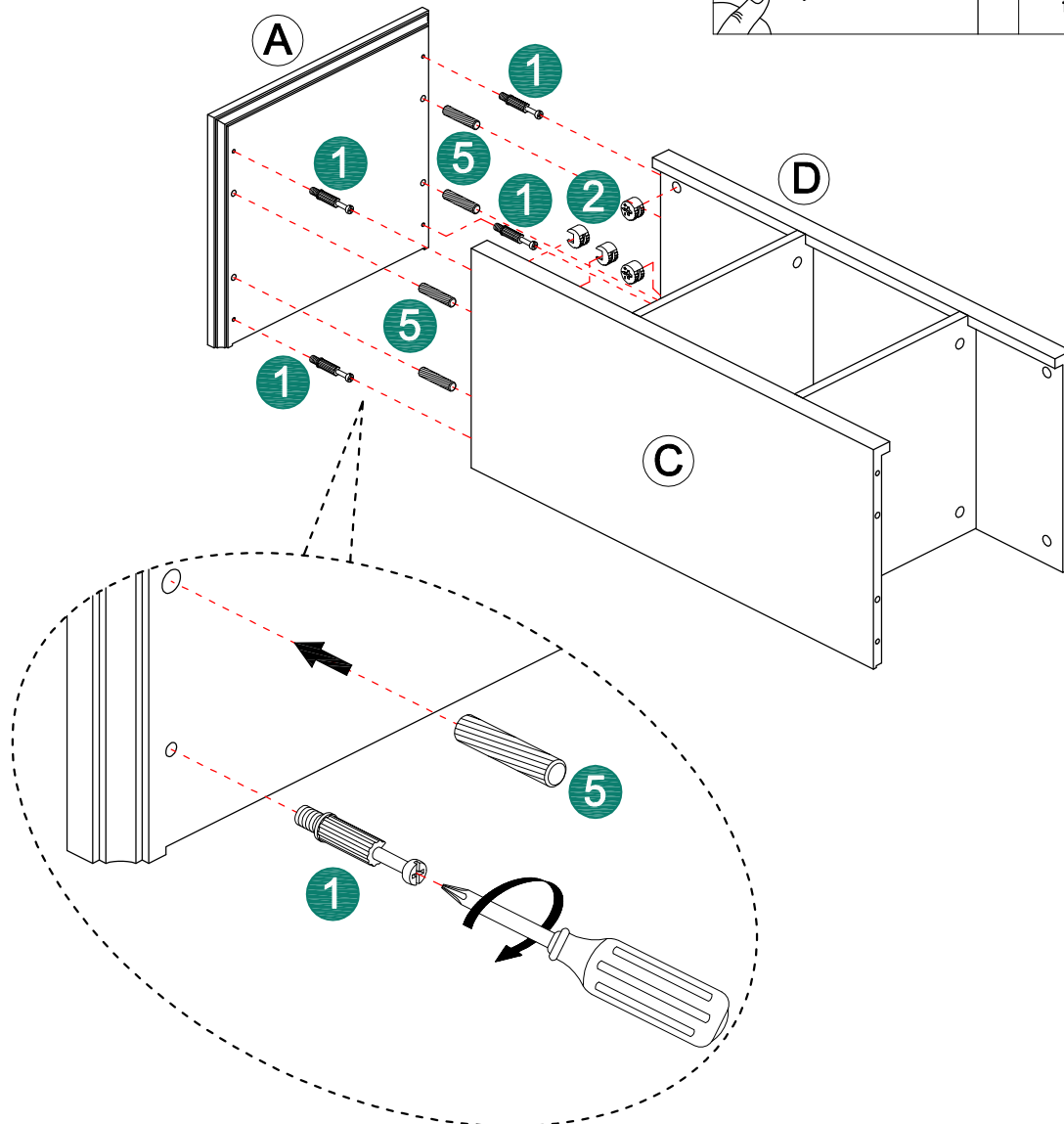
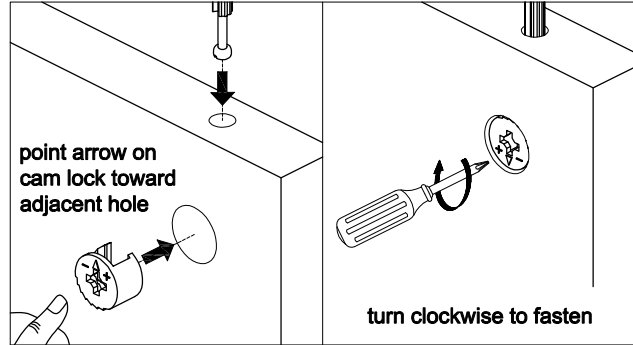

# ASSEMBLY INSTRUCTIONS

3

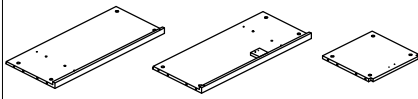

ⓔ 1pc

ⓕ 1pc

ⓖ 1pc

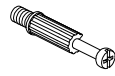

① 4pc



② 4pc



⑤ 4pc

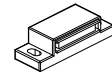

⑥ 1pc



⑧ 2pc

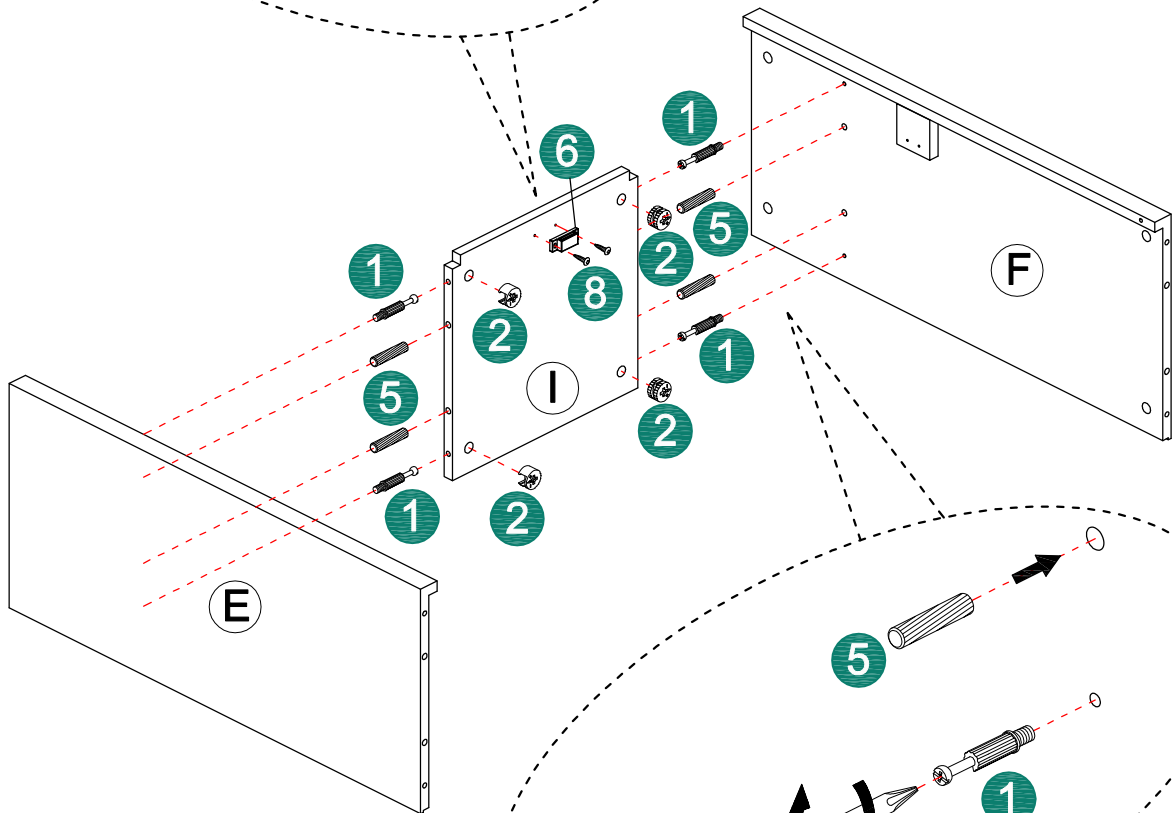
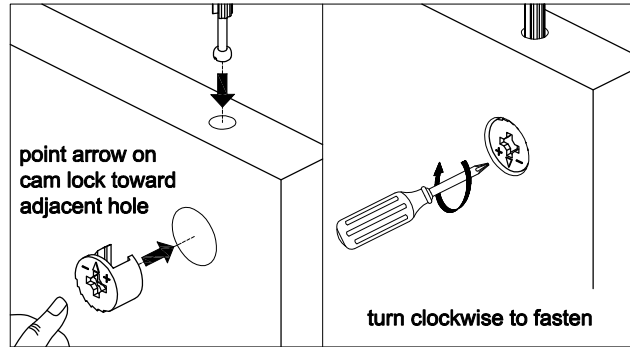
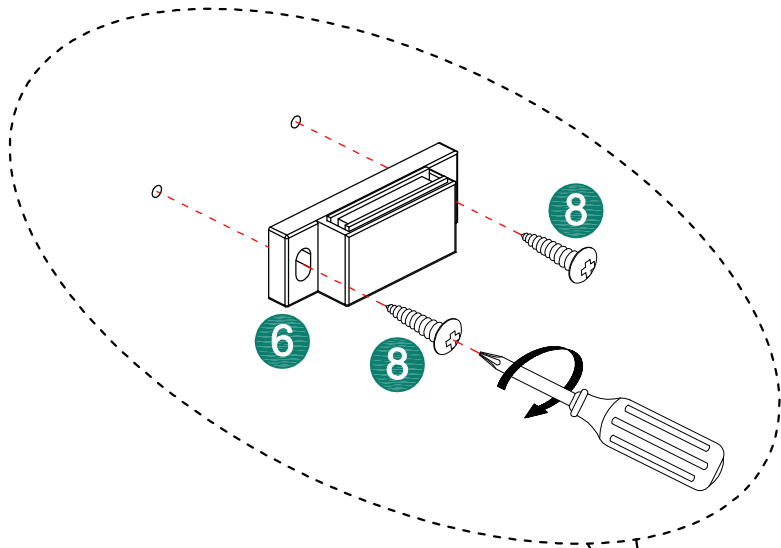

# ASSEMBLY INSTRUCTIONS

4

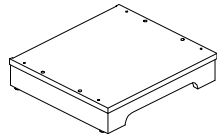

(B) 1pc

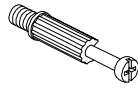

(1) 4pc



(2) 4pc

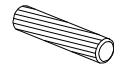

(5) 4pc

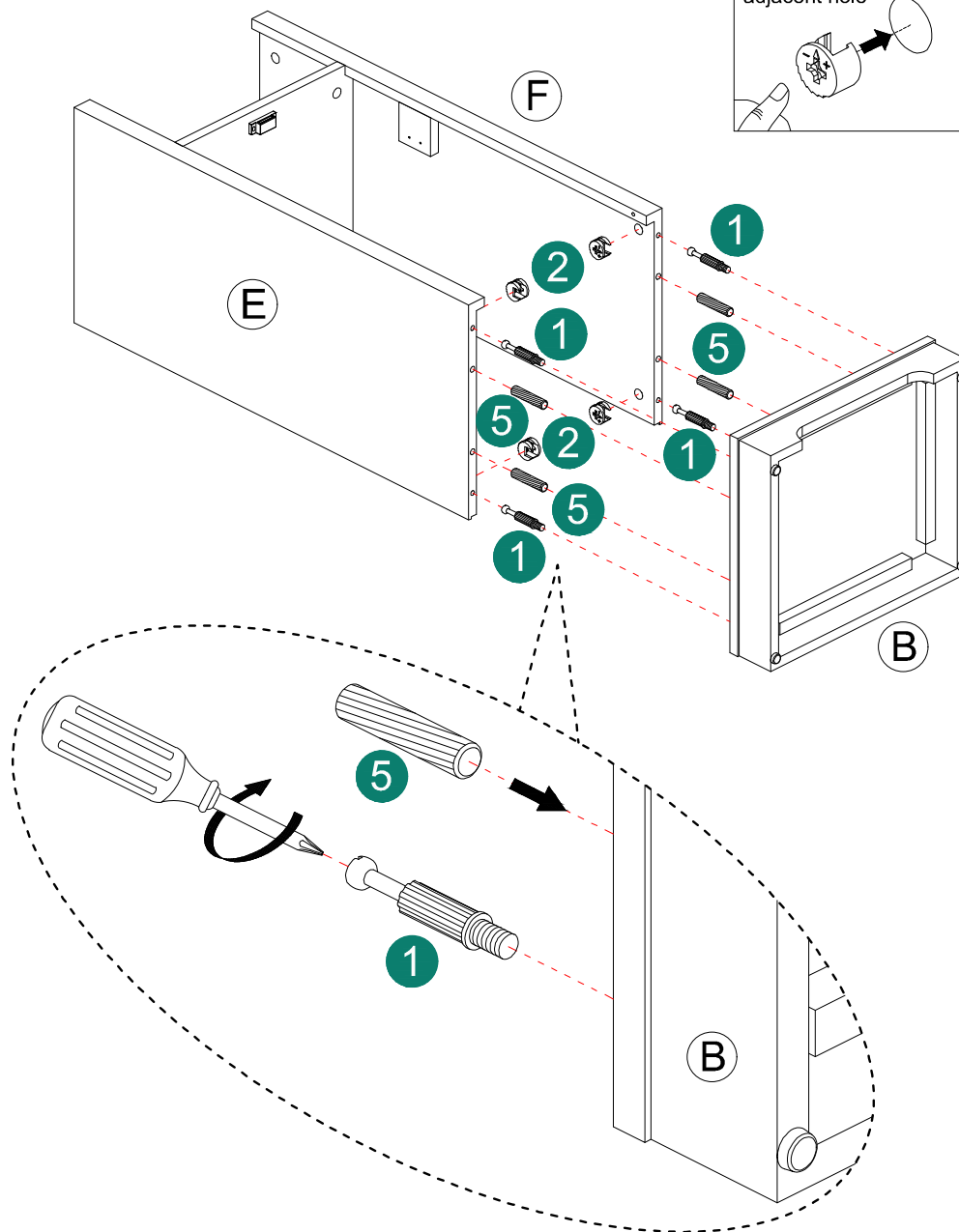
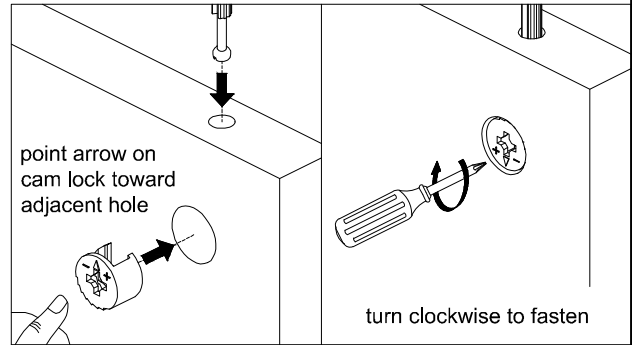

# ASSEMBLY INSTRUCTIONS

5

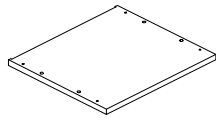

G 1pc

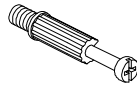

1 4pc



2 4pc

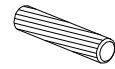

5 4pc

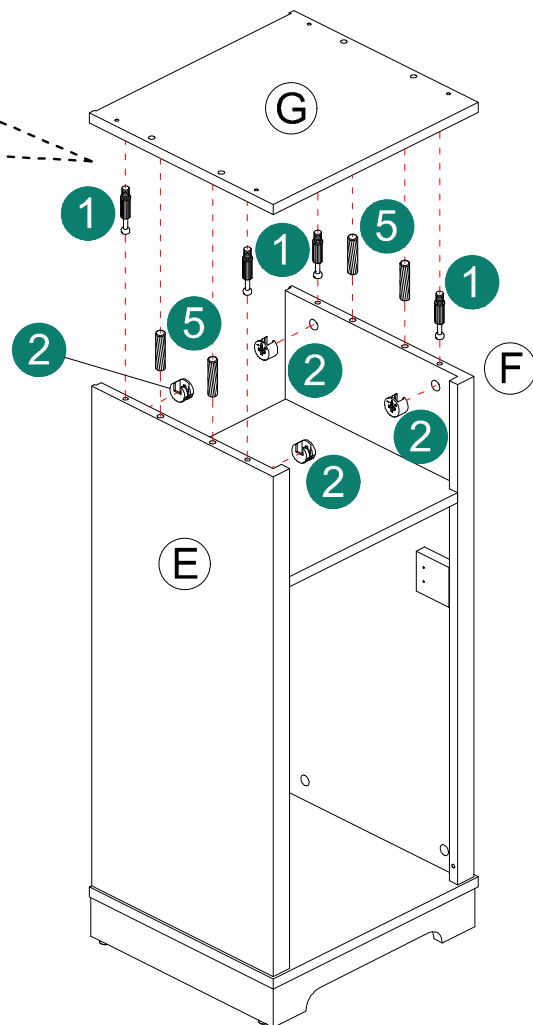
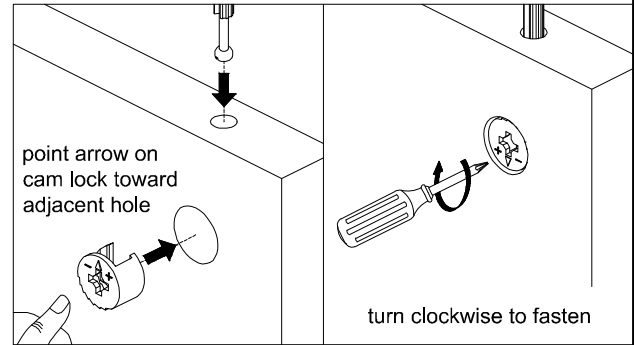
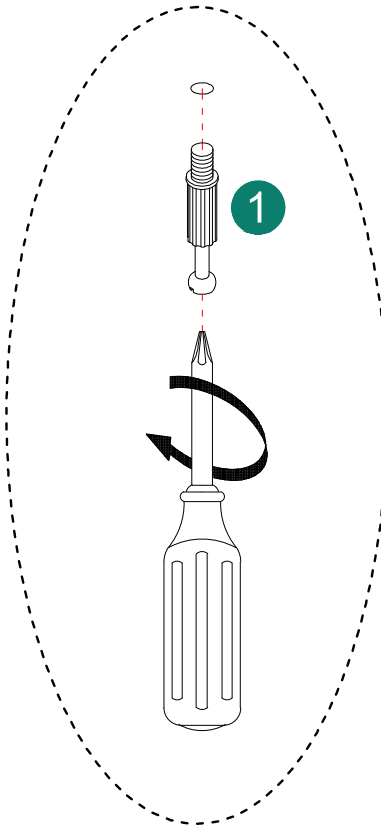

# ASSEMBLY INSTRUCTIONS

6

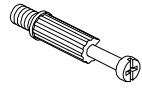

1 4pc



2 4pc

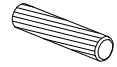

5 4pc

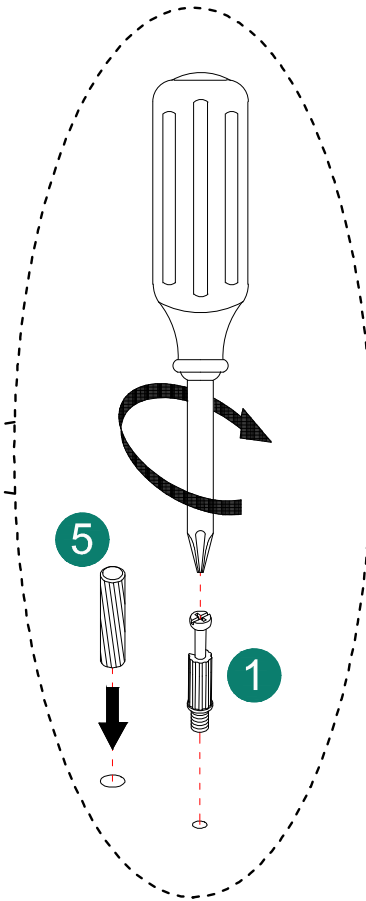
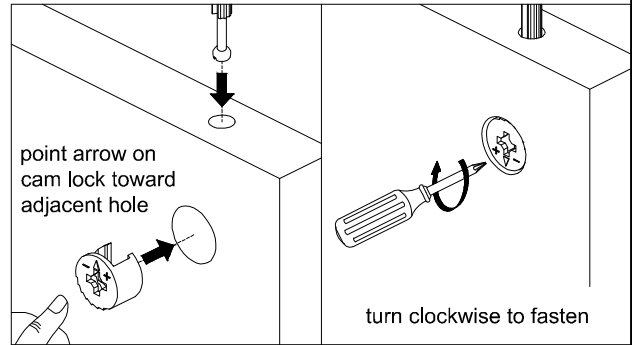
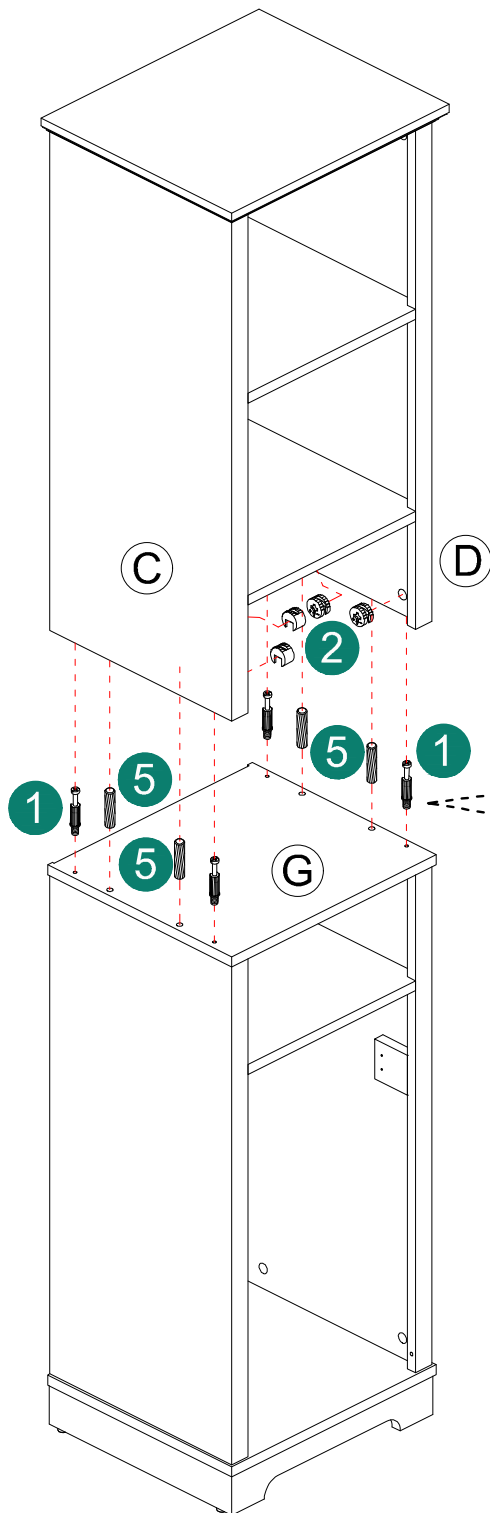

# ASSEMBLY INSTRUCTIONS

7

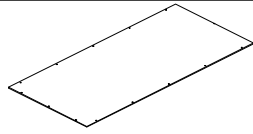

J 2pc



8 27pc

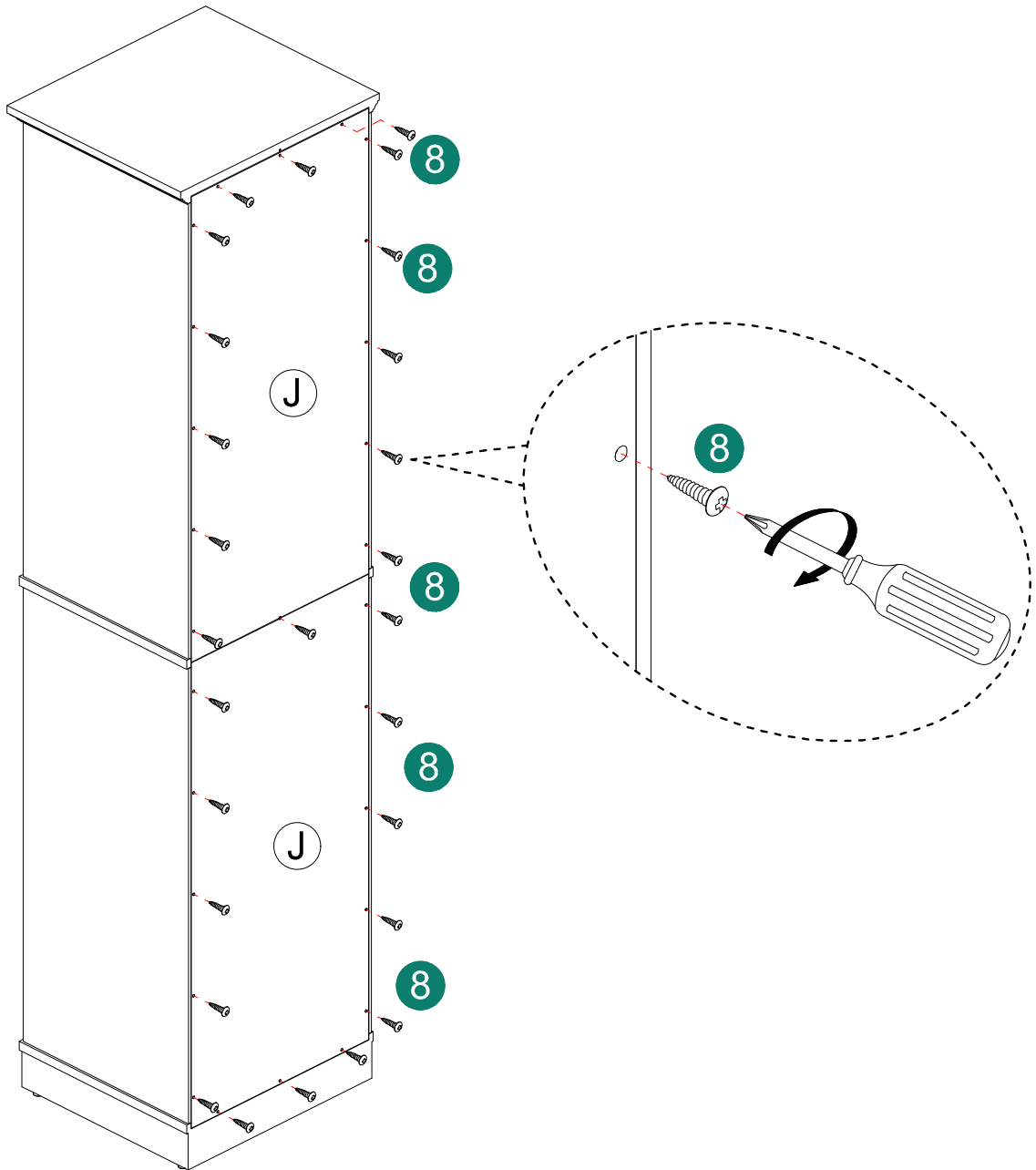

# ASSEMBLY INSTRUCTIONS

8

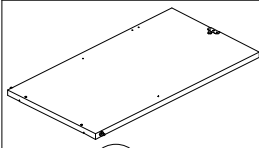

(K) 1pc

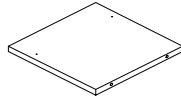

(L) 1pc

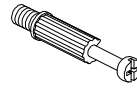

(1) 2pc



(2) 2pc

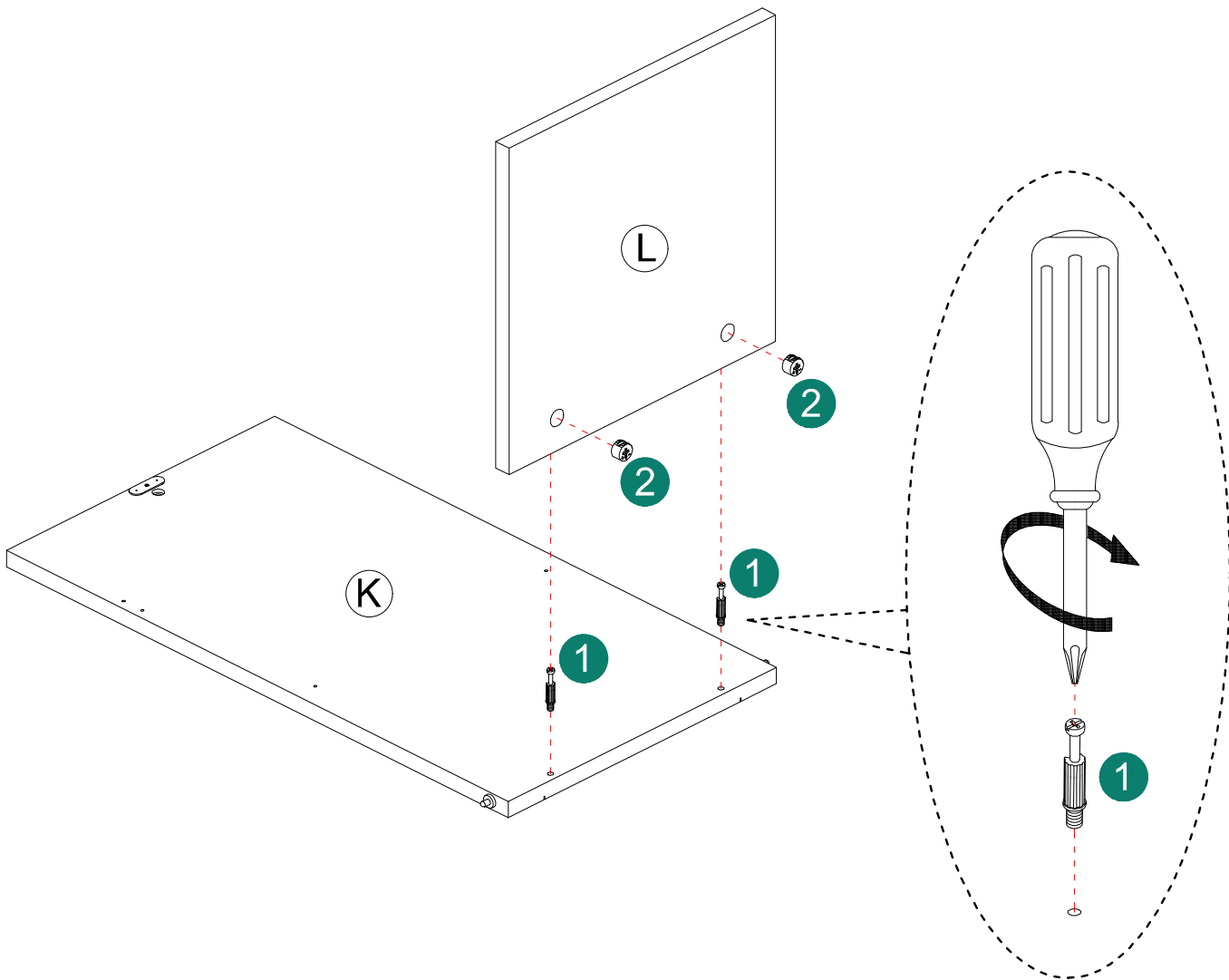
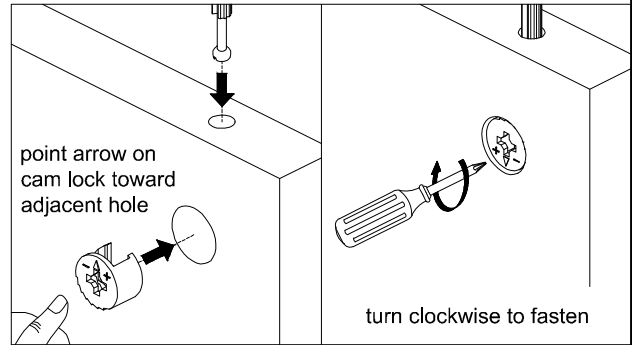

# ASSEMBLY INSTRUCTIONS

9

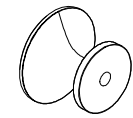

3 1pc



4 1pc



7 4pc

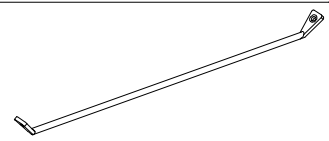

10 2pc

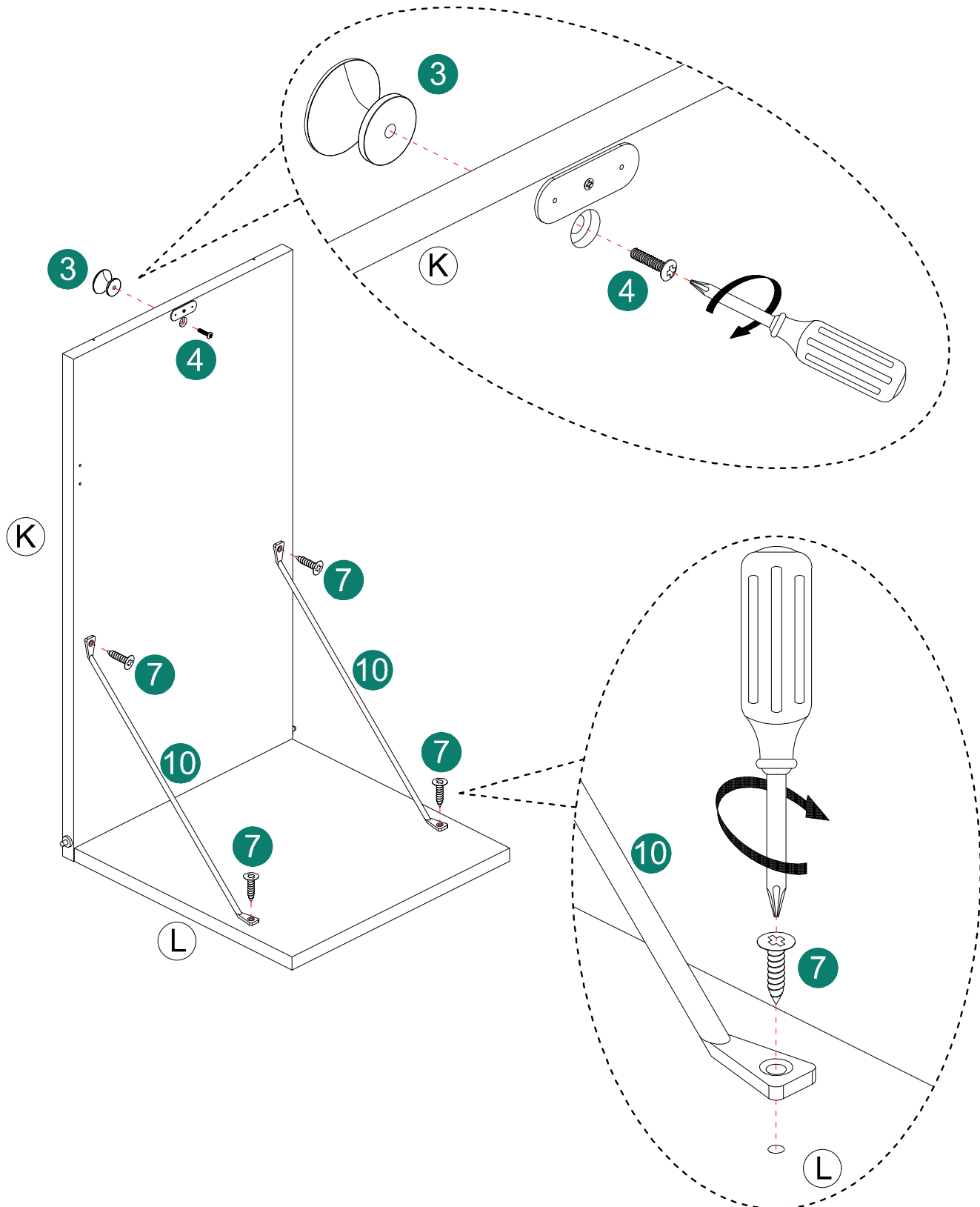

# ASSEMBLY INSTRUCTIONS

# 10

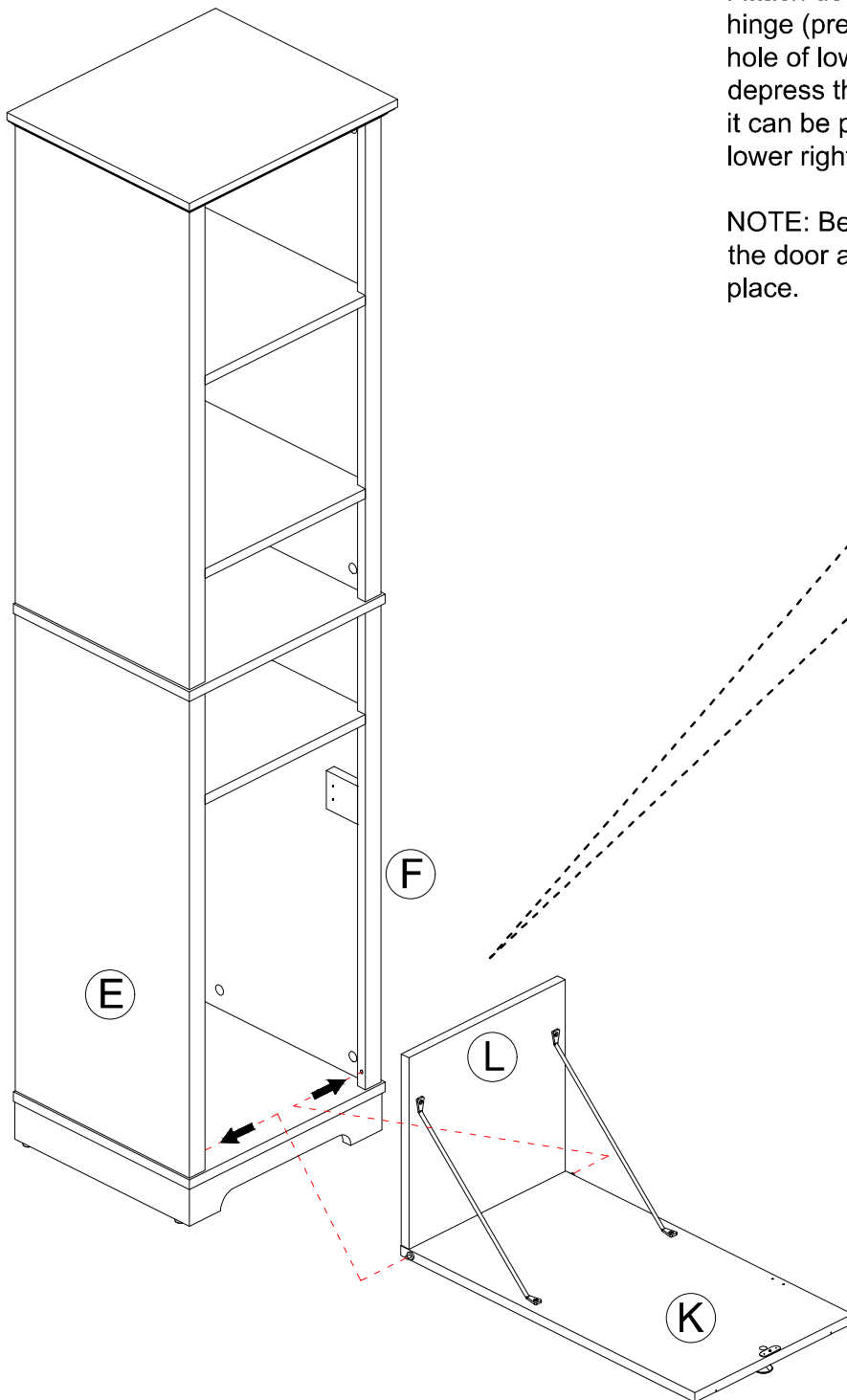

Attach door panels (part K) by placing left pin hinge (pre-installed in door) in the pre-drilled hole of lower left side panel (part E). Then depress the right spring-loaded pin hinge so it can be placed in the pre-drilled hole of lower right side panel (part F).

NOTE: Be sure top and bottom pin hinges of the door are fully extended to secure door in place.

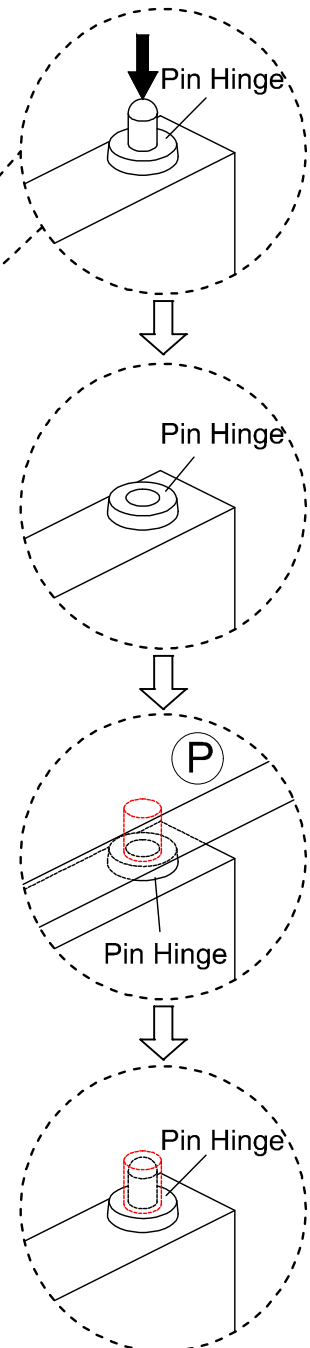

# ASSEMBLY INSTRUCTIONS

11

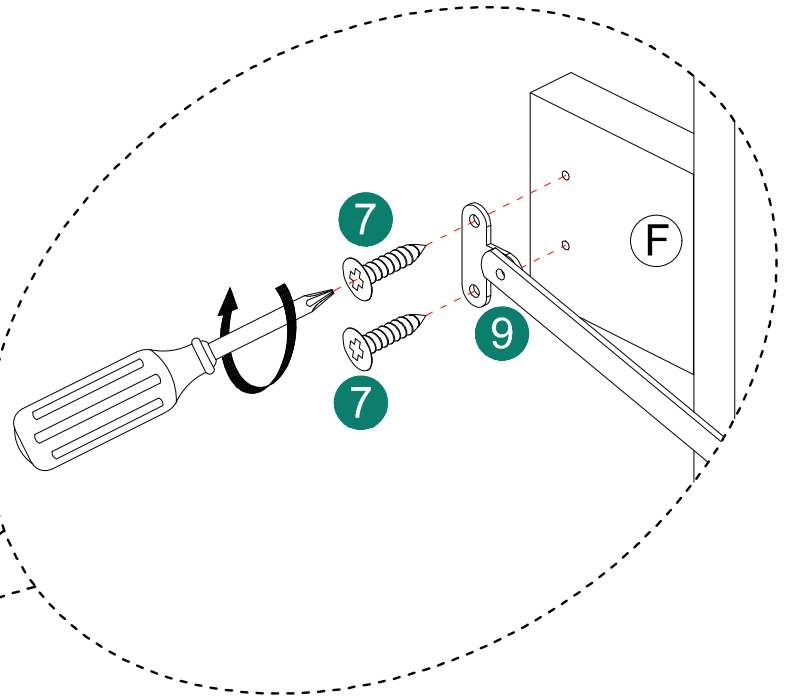
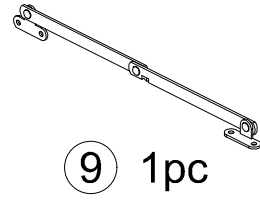
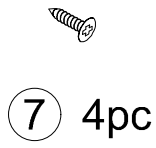

# ASSEMBLY INSTRUCTIONS

12

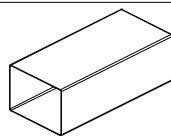

11 1pc

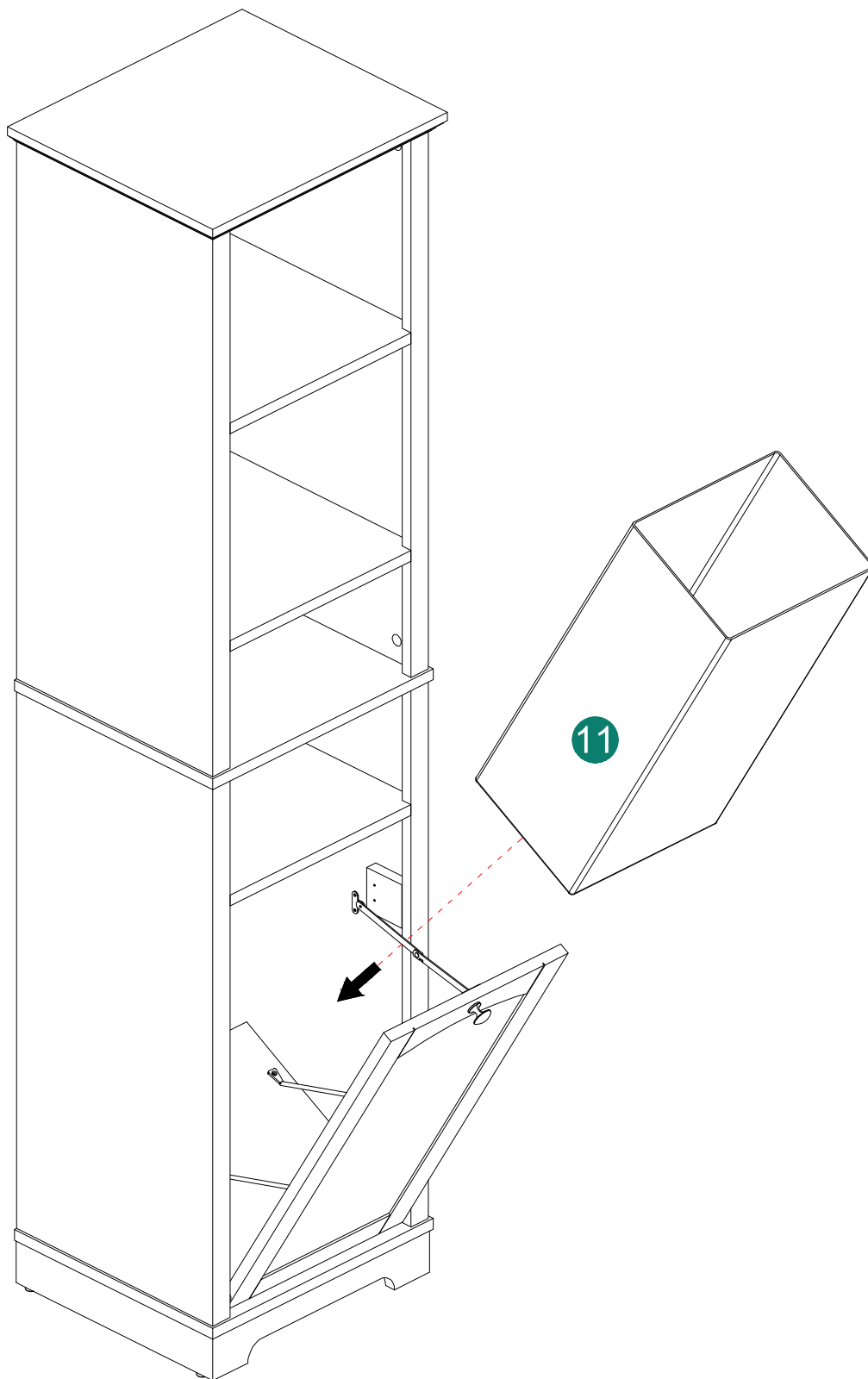

# ASSEMBLY INSTRUCTIONS

# 13

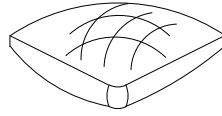

12 1set

A

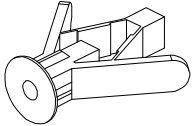

1pc

B

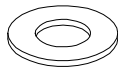

2pcs

C

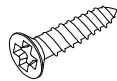

Ø8\*Ø4mm\*3/4"

1pc

D

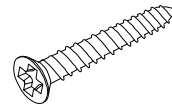

Ø8\*Ø4mm\*1-1/2"

1pc

E

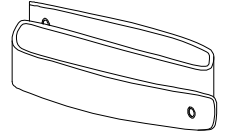

1pc

WALL

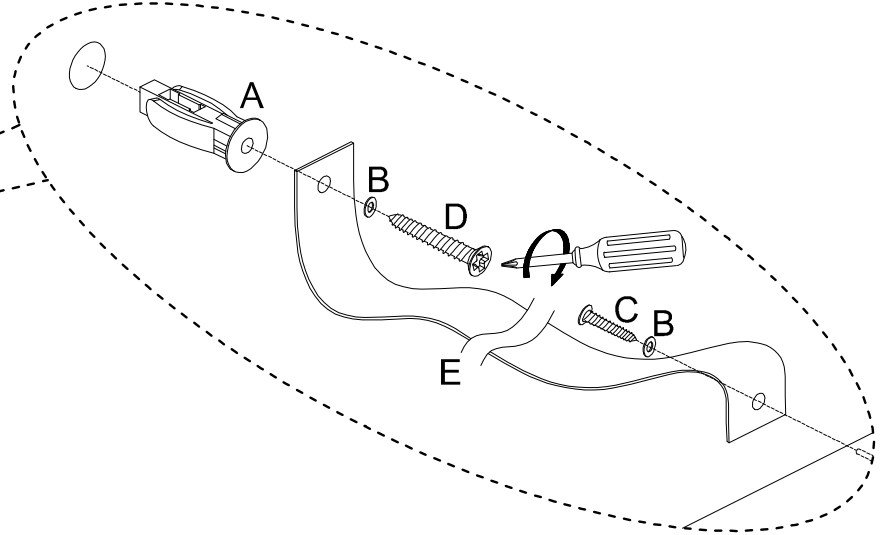
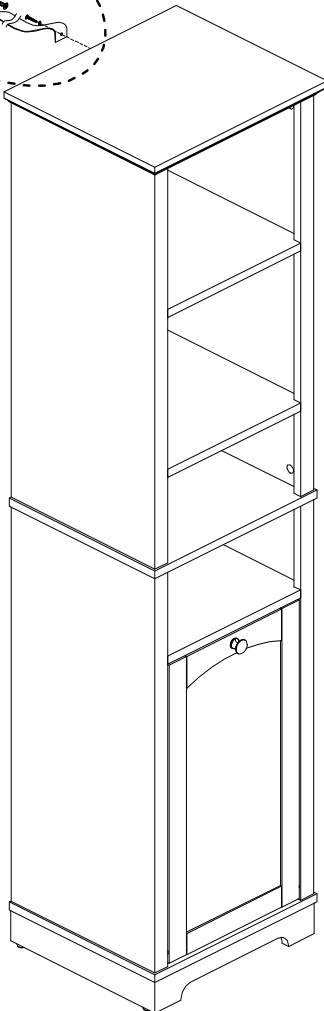

## ⚠ WARNING

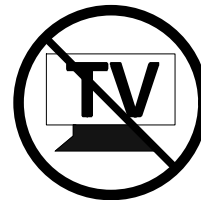

Children have died from furniture tipover. To reduce the risk of furniture tipover:

- ALWAYS install tipover restraint provided.
- NEVER put a TV on this product.
- NEVER allow children to stand, climb or hang on drawers, doors, or shelves.
- NEVER open more than one drawer at a time.
- Place heaviest items in the lowest drawers.

*This is a permanent label.  
Do not remove!*