













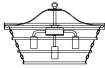



Assembly Instructions

56004258

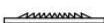
Parts and Tools

A	Mounting Bracket		X 1
B	Canopy		X 1
C	Chain		X 1
D	Open Ring		X 1
E	Lamp Body		X 1
F	Glass		X 85
G	Glass		X 28
H	Glass		X 57
I	Wire Connector		X 3
Z1	Nut for A (Spare Parts)		X 1
Z2	Nut for A (Spare Parts)		X 2
Z3	Non Slip Washer for A (Spare Parts)		X 1
Z4	Non Slip Washer for A (Spare Parts)		X 2
Z5	Glass for F (Spare Parts)		X 2
Z6	Glass for G (Spare Parts)		X 1
Z7	Glass for H (Spare Parts)		X 3
Z8	Clips (Spare Parts)		X 12

Before beginning

- 1) Check and open the numbered packaged bags.
- 2) Read this Assembly Instructions from beginning to end before starting to assemble.
- 3) Take an inventory of the required parts to ensure all are available.
- 4) Assemble the separated parts according to the illustration with the providing tools.
- 5) To prevent accidental choking hazards, keep all packing materials away from small children.
- 6) Only tighten hardware until ALL hardware are fully engaged on their locations. Overtighten bolts will damage the bolt threads.
- 7) Use only factory provided hardware to assemble. Unapproved hardware can damage product or jeopardize the structural integrity of the product.
- 8) The use of power tool to assemble is not recommended due to high risk of over-torque, which can damage the product.

WE RECOMMEND INSTALLATION OF THIS LIGHTING FIXTURE BE DONE BY A LINCENSED ELECTRICIAN.

WARNING*SWITCH OFF THE MAIN ELECTRICAL SUPPLY FROM THE MAIN FUSE BOX/CIRCUIT BREAKER BEFORE INSTALLATION.**

Please make sure power is shut off!

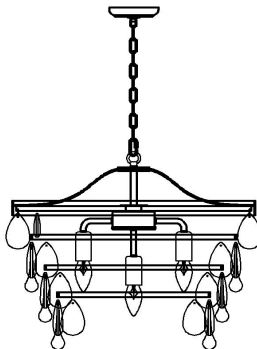

ASSEMBLY REQUIRES
TWO PEOPLE



20 MINUTE
ASSEMBLY TIME



KEEP INSTRUCTIONS
FOR FUTURE USE

Assembly Instructions

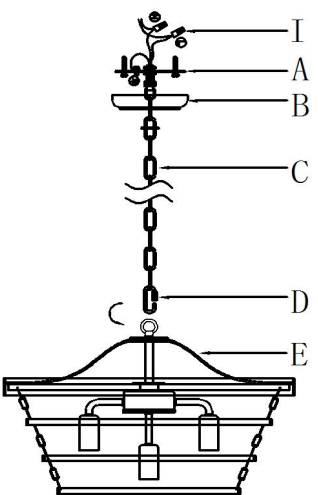
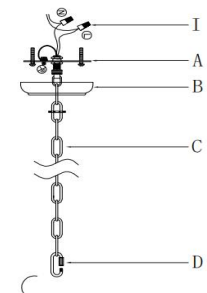

56004258

1

1) Remove the mounting bracket (A) from the canopy (B) by loosening the lock collar.
 2) Use the open ring (D) to link the chain (C) and the loop, then put the cable and naked earth cable through the chain (C) in every 3-4 rings until through the ceiling loop .
 3) **INSURE THE ELECTRICITY SUPPLY IS TURNED OFF**
 4) Affix the mounting bracket (A) on the outlet box.
 5) Wrap both safety cable with wire connector (I) , push the cable into the outlet box.
 6) Attach the canopy (B) to the mounting bracket (A) and secure with lock collar.

2

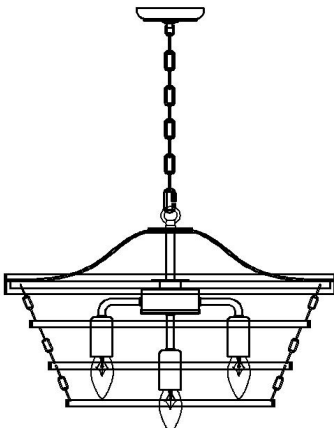
E12 Max 40W

1) Install the bulbs (Not Included), gently hold the bulb firmly and turn clockwise until secured.

3

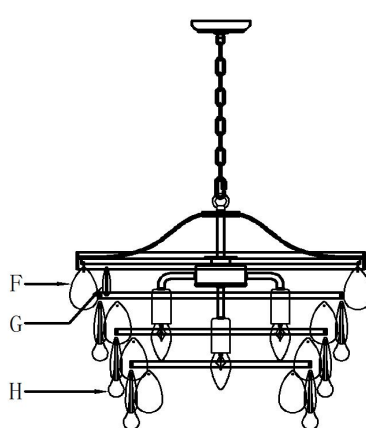

1) Install the glass ornaments (F)/(G)/(H) in the right places according to the illustration.
 2) Installation is finished, turn on power at fuse or circuit breaker.
*****Clean with a dry, soft cloth only, use no harsh abrasives or chemical agents*****