

ASSEMBLY INSTRUCTIONS

SPU: 9002 loveseat

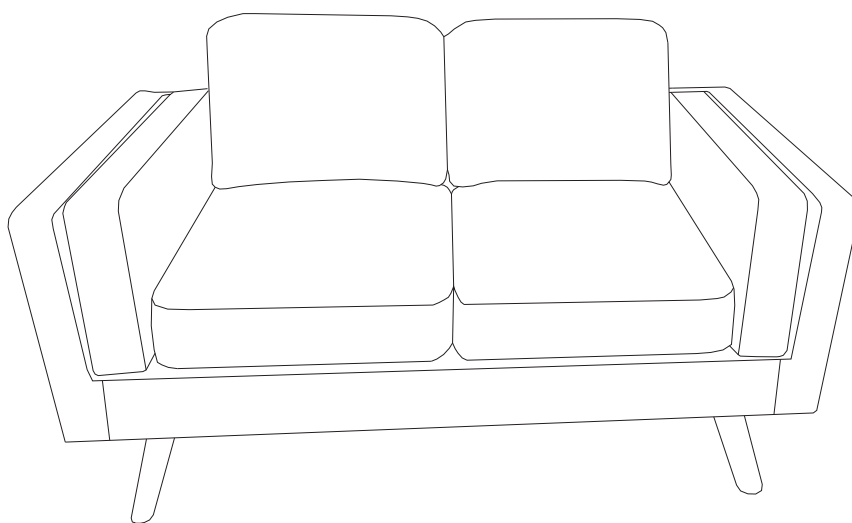

TIME



2 OF PEOPLE



DIFFICULTY

NOTICE

Instruction Booklet - Important Safety Information

Thank you for choosing our product. Please review this booklet carefully for essential safety information and keep it for future reference.

- Upon receiving the product, ***ensure all parts are present and intact*** before proceeding with installation. Follow the entire installation instructions provided.
- During installation, exercise caution and refrain from immediately tightening screws. Secure all screws to 80% before final tightening.

Returns are accepted only for items in their ***original, unopened condition***.



Before installation, please check that the parts are all included !

Carton

Materials ▾

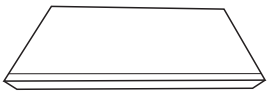

A*1

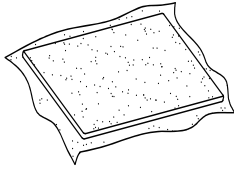

B*2



C*2

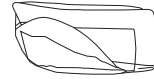

D*1



E*1

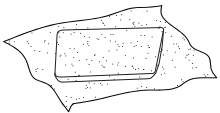

F*2

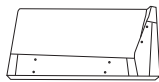

G*1

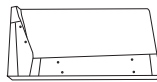

H*1

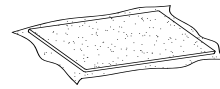

I*2



J*2

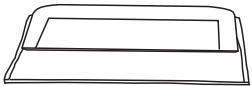

K*1



L*4

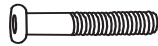

M8*70

①*4



②*4



③*1

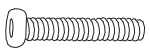

M8*60

⑤*12



⑨*12



⑩*1

Installation Steps

Materials

STEP1

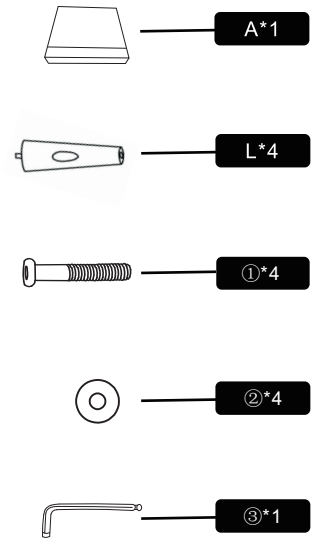
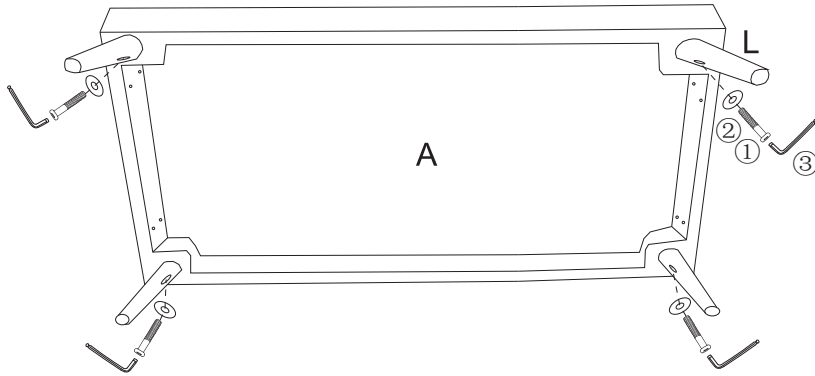

Install the sofa legs: Use screws as shown in the installation diagram for installation.

STEP2

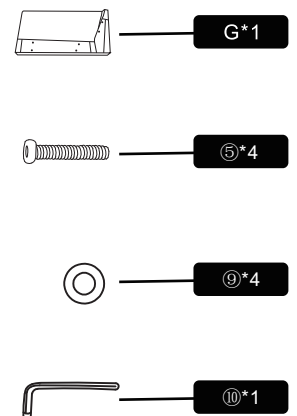
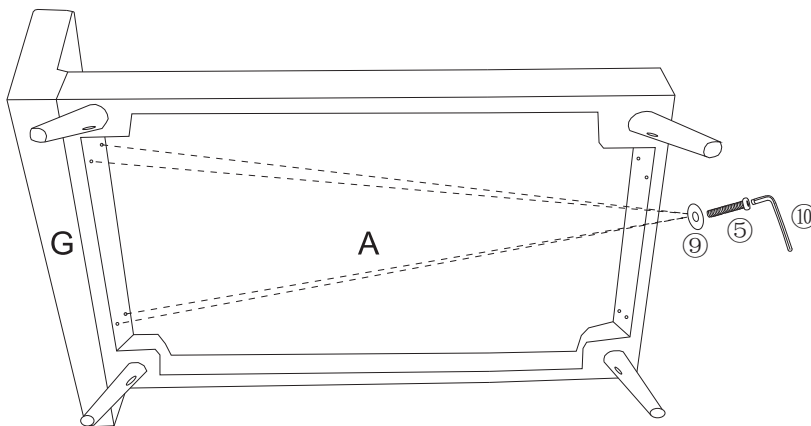

Connect the left armrests with screws, but do not fully tighten them—this will leave room for installing the iron back frame behind.

Installation Steps

Materials

STEP3

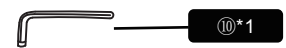
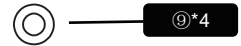
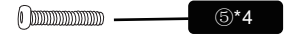
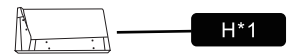
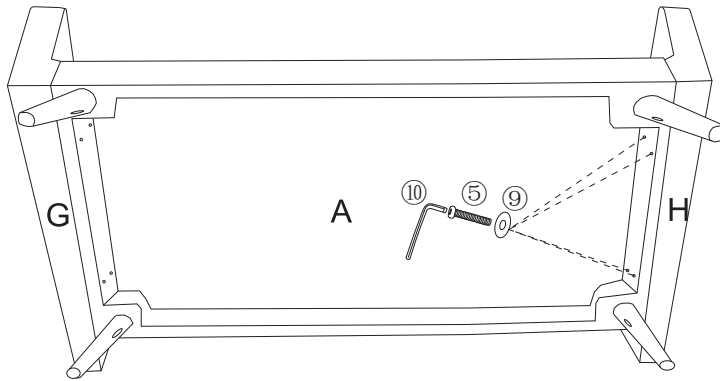

Connect the right armrests with screws, but do not fully tighten them—this will leave room for installing the iron back frame behind.

STEP4

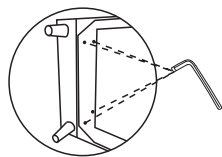

After locking the back frame, lock the left and right armrests again.

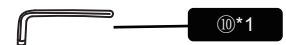
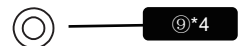
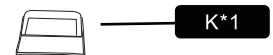
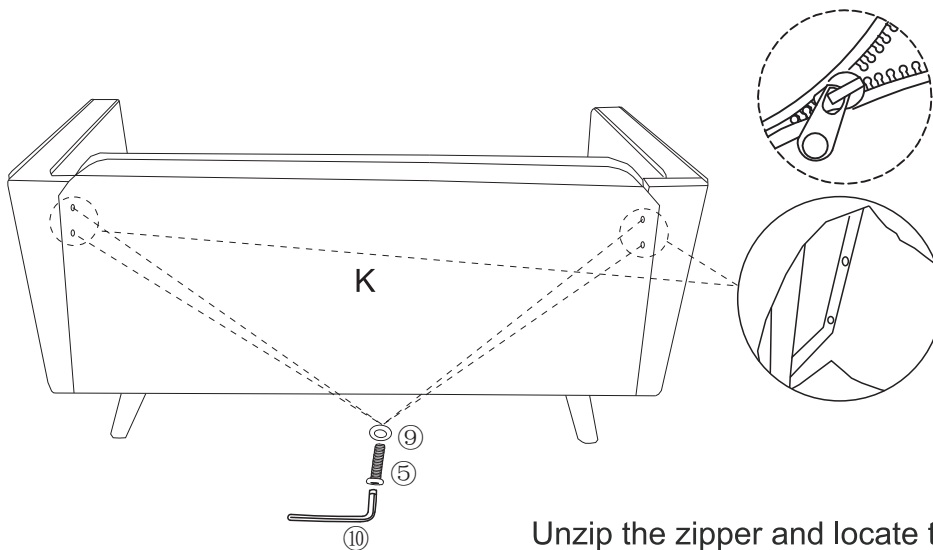

Unzip the zipper and locate the hole position. Lock the iron back frame and lock the armrest.

Installation Steps

Materials ▾

STEP5

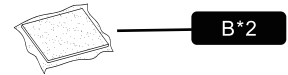

B*2

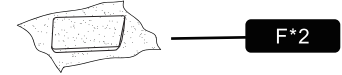

F*2

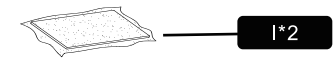

I*2

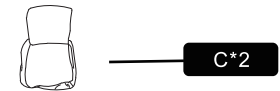

C*2

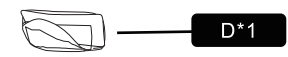

D*1

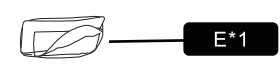

E*1

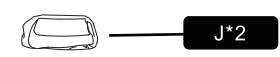

J*2

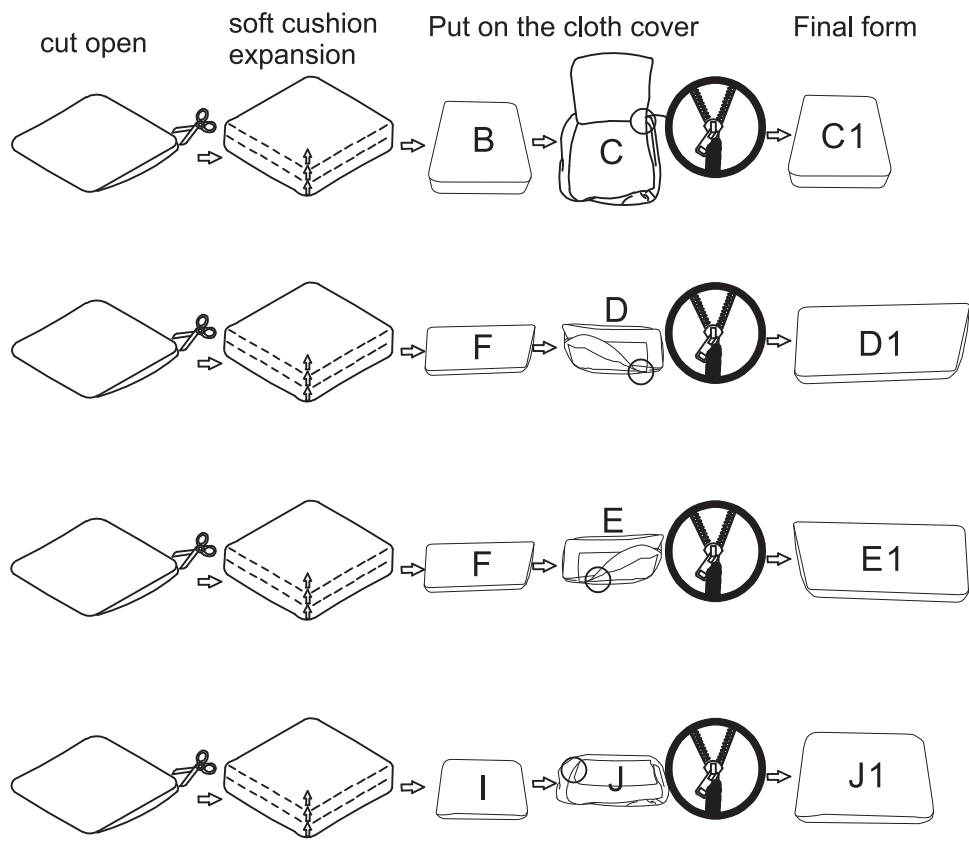

The cushion are compressed and require a recovery period after opening, with a maximum recovery time of 48 hours.

Installation Steps

Materials ▶

STEP 6

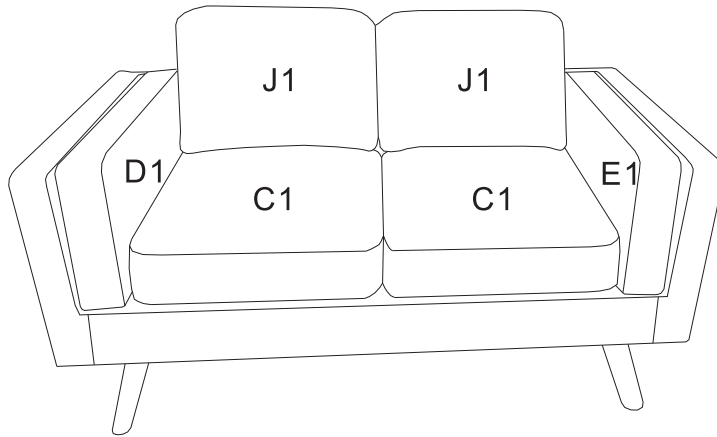

Place the soft cover according to the illustration.

COMPLETE

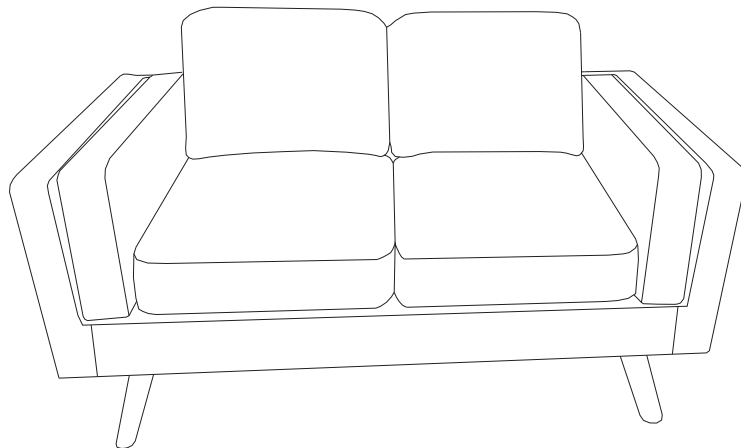

Frequently Asked Questions

We understand that receiving damaged or defective products can be disappointing, and we're here to assist you every step of the way. Here's how to address common concerns and initiate a damage claim:

1.What should I do if my shipment is damaged or products received are defective?

We're genuinely sorry to hear about any inconvenience caused. Please reach out to us promptly, and our team will prioritize resolving the matter swiftly and effectively, please retain the original box in case a return is required.

2.Can I return the product if I'm not satisfied?

While we uphold stringent quality standards and collaborate with experienced manufacturers, we acknowledge that dissatisfaction may arise. If you're still unsatisfied, of receiving the product. Simply message us with your reasons for return, and we'll facilitate the process.