









Door Canopy

Note to Customers:

- Please ensure that you check all the contents of your delivery packaging against the contents list on the enclosed Instruction Manual.
- Keep all the packaging including internal fittings until you have successfully put together and installed your purchase.
- We will only accept a return of this product if it is repacked in the original packaging
- Should you require further details or assistance, please contact our customer care line on 01562 753040

List of Components:

Part	Component	Quantity	Part	Component	Quantity	Part	Component	Quantity
A	 Canopy	1	B	 Front Fixing Bar	1	C	 Bracket	2
D	 Back Fixing Bar	1	E	 Expansion Bolt	4	F	 Rubber Sealant	1
G	 Fixing Screw	4	H	 Expansion bolt head cover	4			

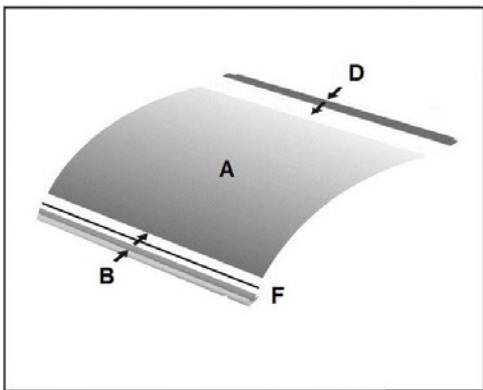

- Put the rubber seal(F) across all sides of the Canopy (A),
- Slide on the front bar (B).
- Slide on the back bar (D).



A good tip here is to tape the rubber seals into place with the long edge seals going to the end of the sheet and the short edges going between the rubbers on the long sides

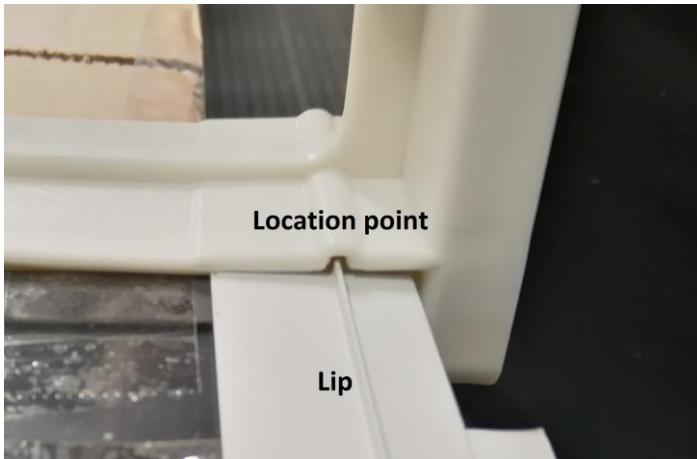

- Insert into brackets,
- Make sure the lip on the back bar goes into the location point on the bracket



Feed the canopy down the location groove,

Don't worry at this stage if the canopy appears to be short, the next step will make good.



Using two people hold the canopy sheet in the groove and **GENTLY** tap the end of the bracket. Until the metal front bar locates into the bracket

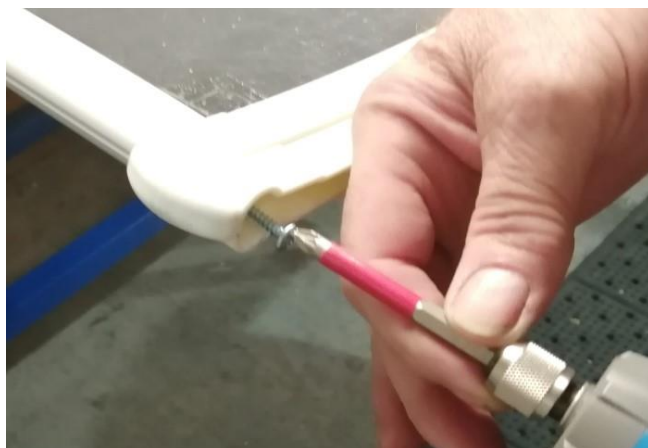

Using the long screws fix through the bracket into the front and back bars.

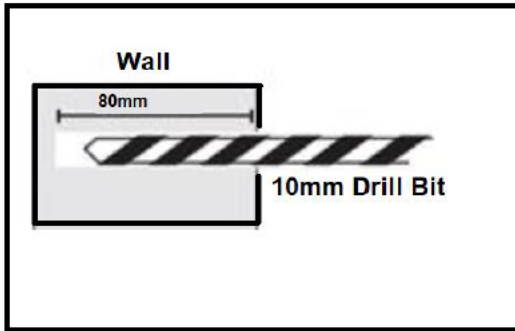

- Mark the position of the four holes you need to drill, these will be dependent on the height and position you want to fix the canopy.
- Using a 10mm masonry drill bit make the holes.
- Once the holes are drilled you will need to line the assembled door canopy up with the drilled holes.

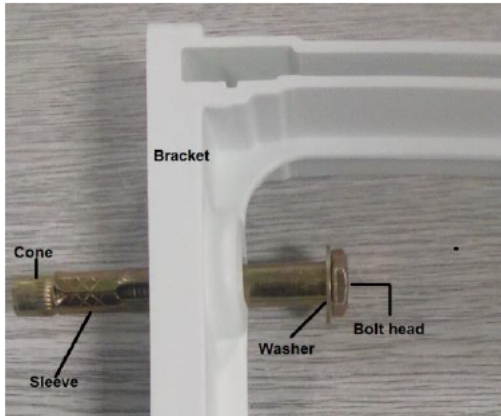

- Insert the complete expansion bolt through the bracket holes into the drilled hole in the wall.
- Use a spanner to tighten the expansion bolt, this will pull the cone/nut through the sleeve on the expansion bolt causing the sleeve to expand and clamp to the wall and fix the canopy into position.
- Once the nuts are tightened cover the head of the expansion bolt using Part H.

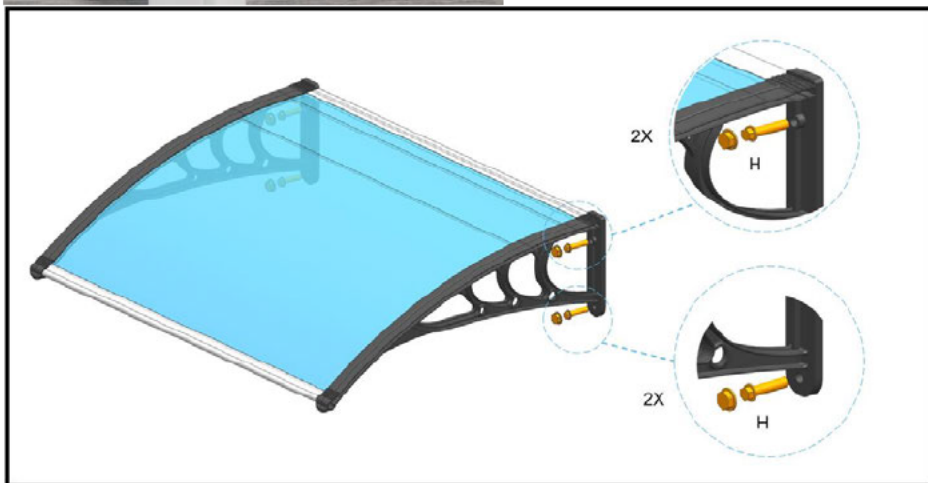

How an Expansion Bolt Works.

- Expansion bolts can be used to secure heavy objects to walls or floors.
- Can handle vertical and horizontal loads.
- By tightening the bolt, the nut on the opposite end pulls into the sleeve, expanding the split to flange outward and wedging it inside the hole in the wall or floor.
- Requires a spanner or socket wrench to fasten or undo the bolt.
- The hole for the bolt needs to be the same depth as the bolt.

