

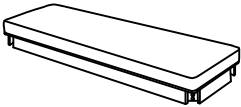



ASSEMBLY INSTRUCTION

ESPRESSO FINISH BENCH

| | | | | |
|---|---|---|--|---|
| A Bench | B Leg | C Lock Washer | D Flat Washer | E Bolt 5/16"x2-1/2" |
|  |  |  |  |  |
| 1pc | 4pcs | 8pcs | 8pcs | 8pcs |

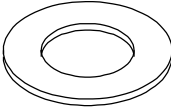
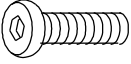
| |
|---|
| F Allen Wrench |
|  |
| 1pc |

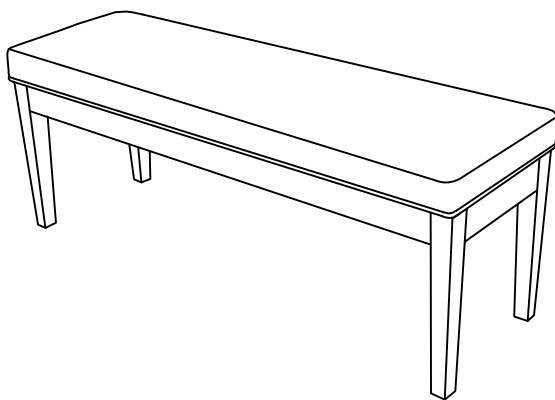

This page lists all the contents included in the box. Please take the time to identify the hardware as well as the individual components to this product. As you unpack and prepare for assembly, place the contents on a carpeted or padded area to protect them from damage.

1

Put the bench (A) on a smooth flat surface, attached one leg (B) to the bench (A) use bolt (E), lock washer (C) and flat washer (D) on both of hole of bench. Turn the allen wrench (F) in bolt (E). But not too tight.

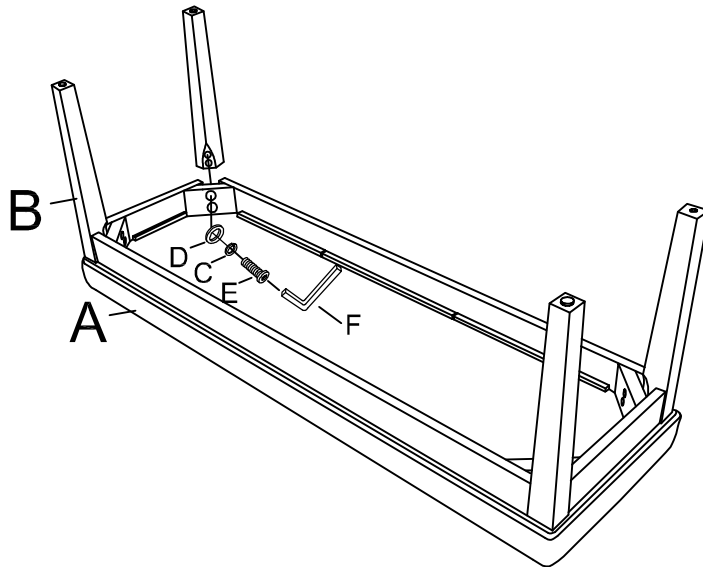

Cleaning & Care

Treat surface with care. Surface is resistant to scratches but is not scratch resistant. Clean surfaces with a dry or damp soft cloth. Do not use abrasive cleaners. Hardware may loosen over time. Periodically check that all connections are tight.