

Top View

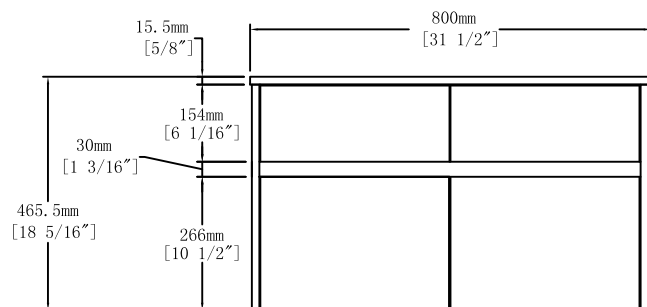

Front View

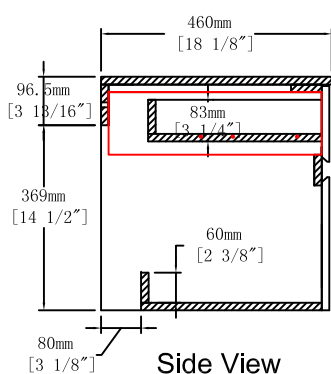

Side View

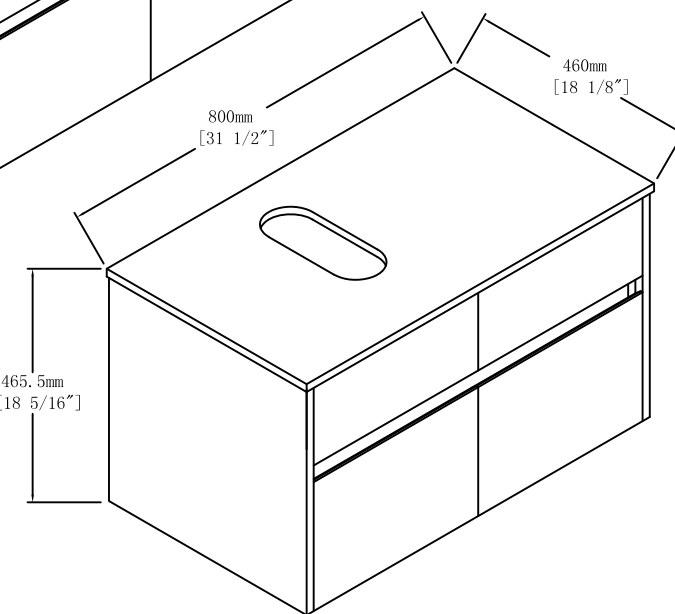
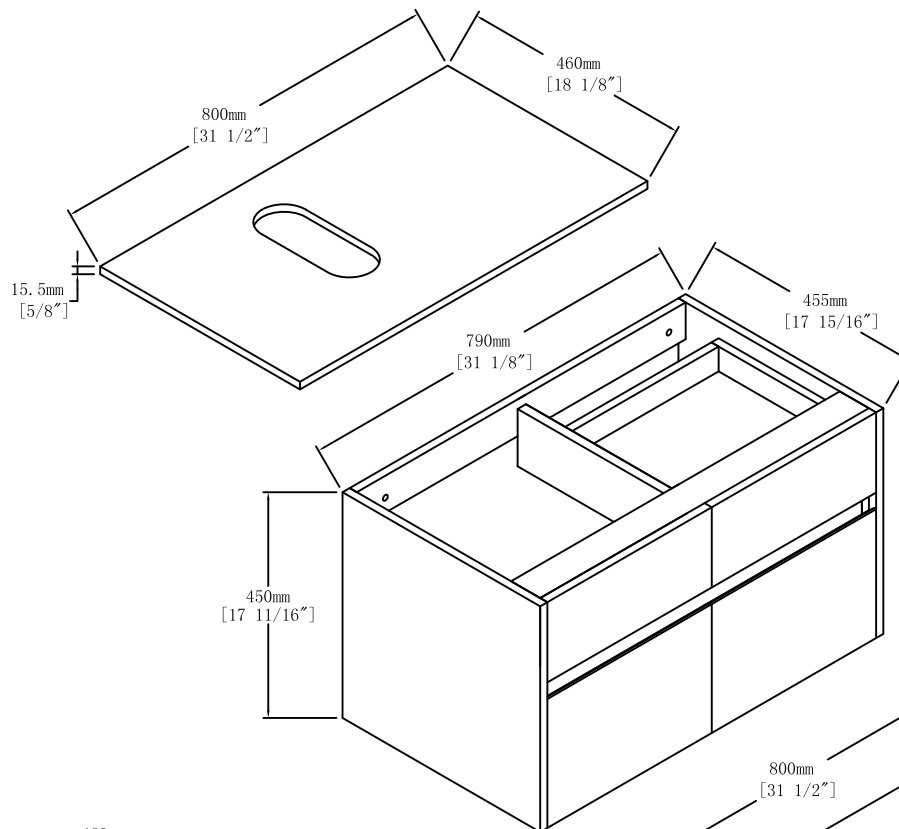

Item NO.

BV B13432

Version

V1

Project

Date

2025-4-14