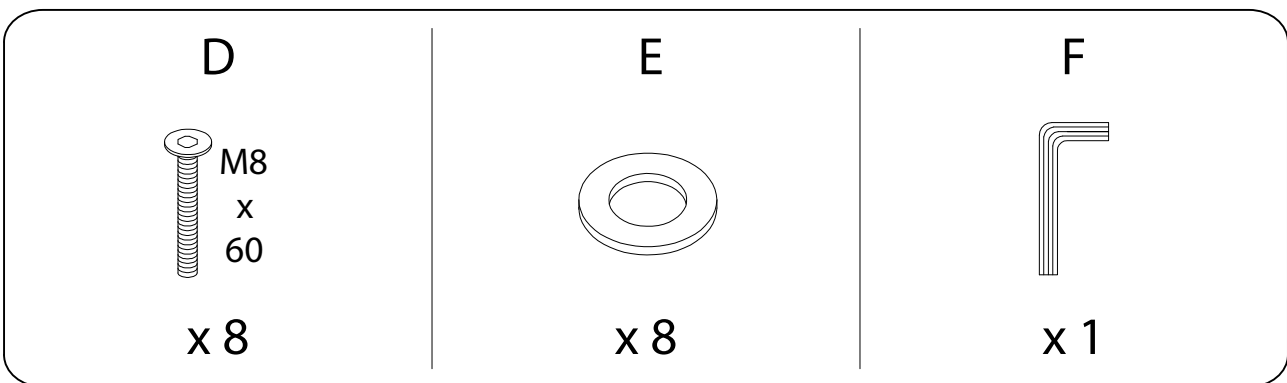
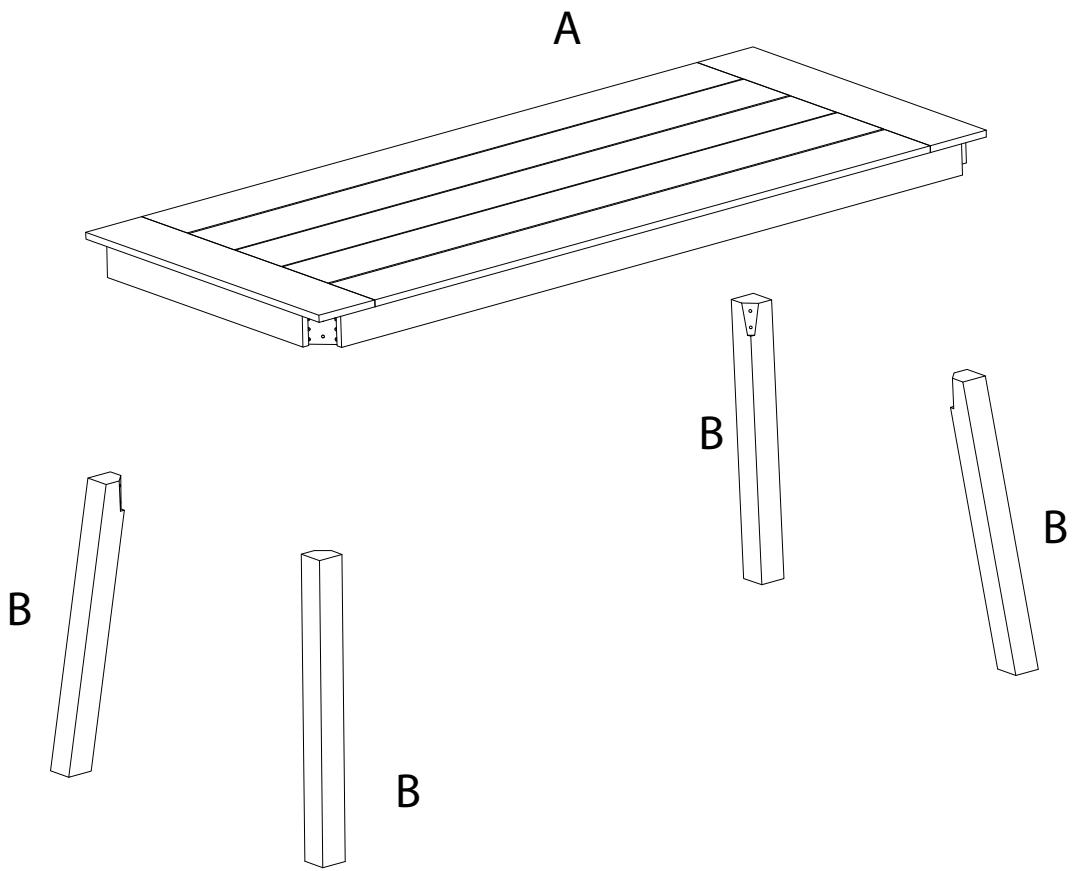
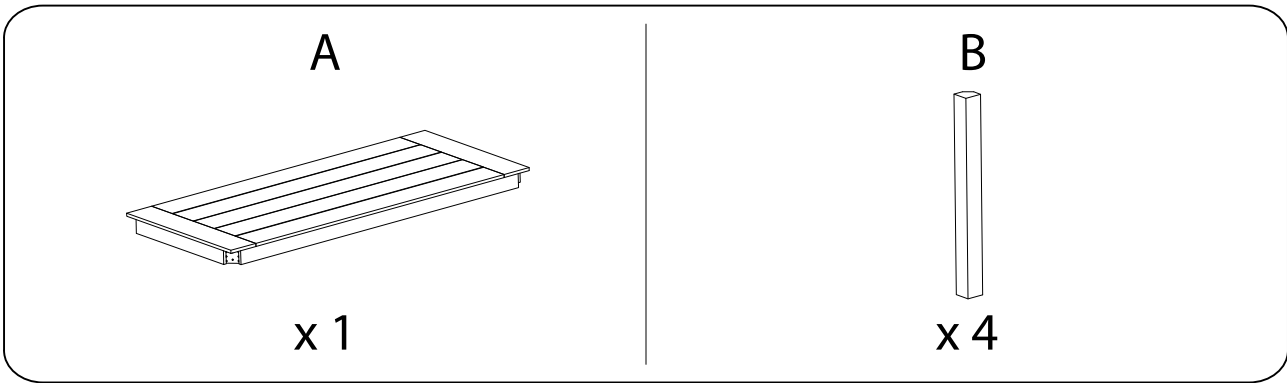
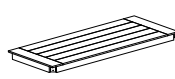

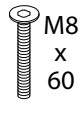

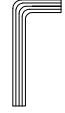

Diagram illustrating assembly steps and safety warnings:

- Step 1:** Shows an L-shaped bracket being inserted into a hole in the table leg. A power drill is shown with a slash through it, indicating that a power drill should not be used for this step. A warning triangle with an exclamation mark is positioned to the right.
- Step 2:** Shows a rectangular block being placed on a surface. A power drill is shown with a slash through it, indicating that a power drill should not be used for this step. A warning triangle with an exclamation mark is positioned to the right.
- Time:** A clock icon is shown, indicating a time requirement of 20 minutes.
- Personnel:** An icon of a person is shown, indicating that 2 people are required for assembly.



1

<p>A</p>  <p>x 1</p>	<p>B</p>  <p>x 4</p>	<p>C</p>  <p>M8 x 60</p> <p>x 8</p>	<p>D</p>  <p>x 8</p>	<p>E</p>  <p>x 1</p>
-------------------------------------------------------------------------------------------------------	-------------------------------------------------------------------------------------------------------	------------------------------------------------------------------------------------------------------------------------------	---------------------------------------------------------------------------------------------------------	---------------------------------------------------------------------------------------------------------

