

# ASSEMBLY INSTRUCTION

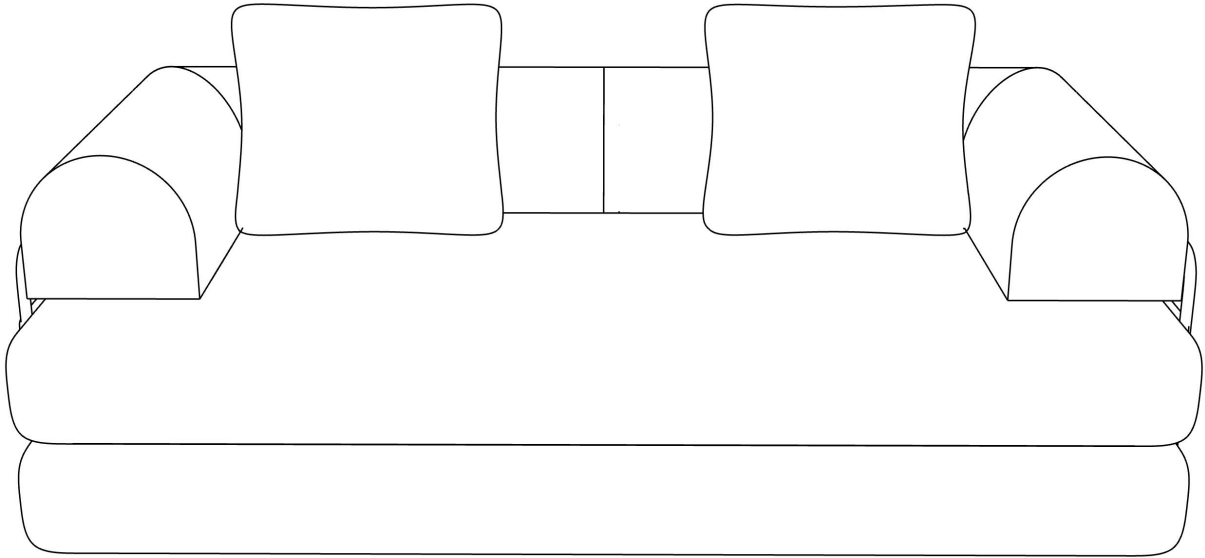

## Your Satisfaction, Our Priority

We are committed to providing top-quality products and doing our utmost to ensure every customer is fully satisfied, offering replacement parts or services as needed.

## TIPS

1. Due to differences of light effects, the actual color of the upholstery may vary slightly from what is shown in the pictures.
2. No Assembly Required. This sofa bed saves you from the common hassle of complicated furniture assembly.
3. Due to package compression for better shipment, the upholstery may have wrinkles upon arrival.
4. After unboxing, take all parts out and gently pat them to help the sponge rebound and regain its original fluffy appearance.
5. Safety Warning - Keep children away from plastic bags for safety.
6. If your item arrives damaged or defective, please do not return it directly to the store. Instead, contact us as soon as possible, and we will provide a prompt and satisfactory solution, including replacement parts or a refund.

 (24H/7DAYS): [service@kmcglobe-us.com](mailto:service@kmcglobe-us.com)  
 (only us) +1 213-816-4788(24H/7DAYS)

# PACKING LIST

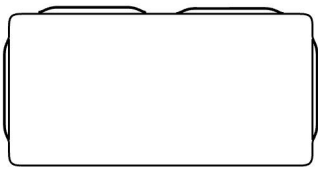
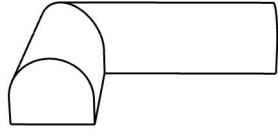
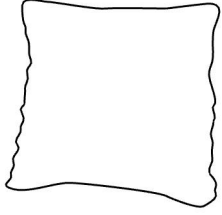
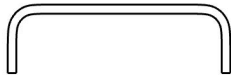
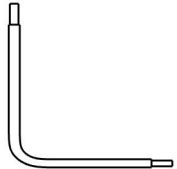
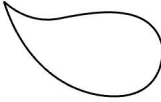
1.  <b>Cushion (2PCS)</b>	2.  <b>Armrest and backrest (2PCS)</b>
3.  <b>PILLOWS (2PCS)</b>	4.  <b>U-BRACKET (8PC)</b>
5.  <b>L-BRACKET (8PC)</b>	 <b>PLASTIC BOX OPENER (1PC)</b>

## ASSEMBLY INSTRUCTION

**STEP 1.** Take all the parts out of the Paper box.

Use the included plastic box opener to cut open the first package layer.

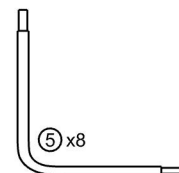
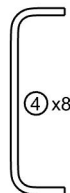
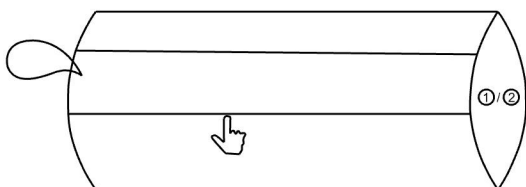
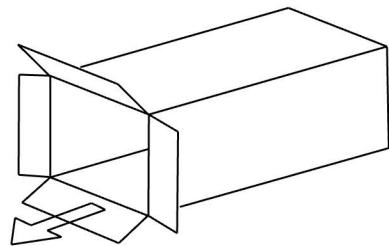
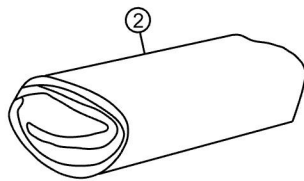
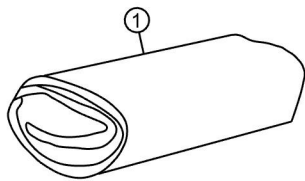

## ASSEMBLY INSTRUCTION

**STEP2.** Use the box opener again to cut open the second package layer.

Attention: The sofa will be released from the vacuum state and begin to inflate.

Please ensure safety during this step to avoid injury from the expanding sofa.

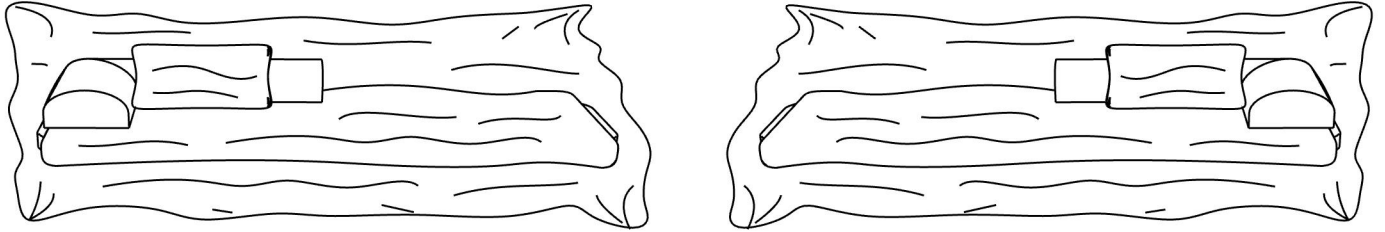

## ASSEMBLY INSTRUCTION

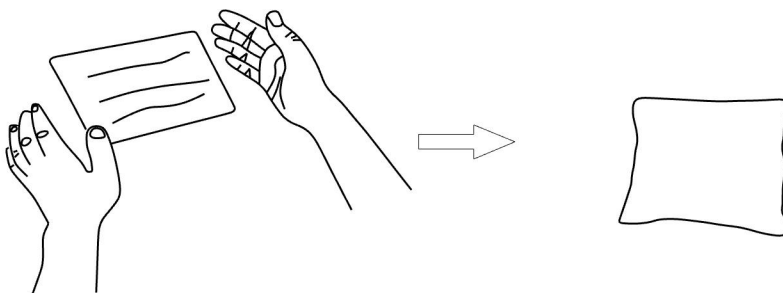

Fluff up the pillows for comfort.

## ASSEMBLY INSTRUCTION

**STEP3:** Use the box opener again to cut open the second package layer.  
Attention: The sofa will be released from the vacuum state and begin to inflate.  
Please ensure safety during this step to avoid injury from the expanding sofa.

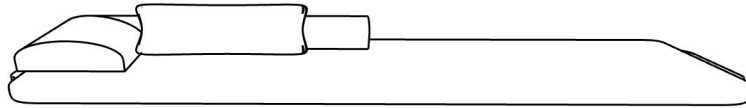

## ASSEMBLY INSTRUCTION

**STEP4:** After opening the package, leave the bean bag undisturbed for 72 hours to allow the foam to fully expand to its original shape.

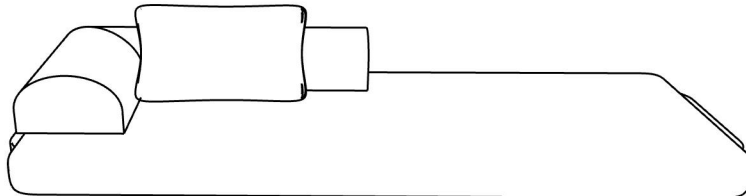

## ASSEMBLY INSTRUCTION

**STEP5:**Lazy sofa form.

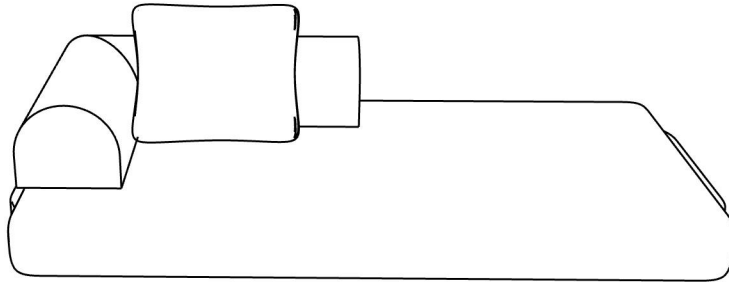

## ASSEMBLY INSTRUCTION

**STEP6:**Assemble the iron frame.

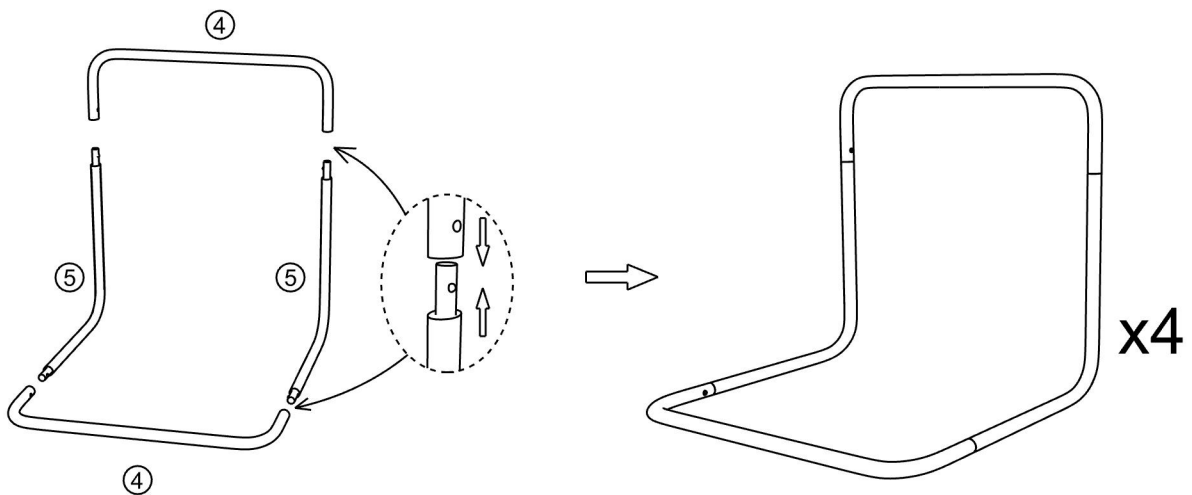

## ASSEMBLY INSTRUCTION

**STEP7:**Install the assembled iron frame onto the sides and back of the sofa.

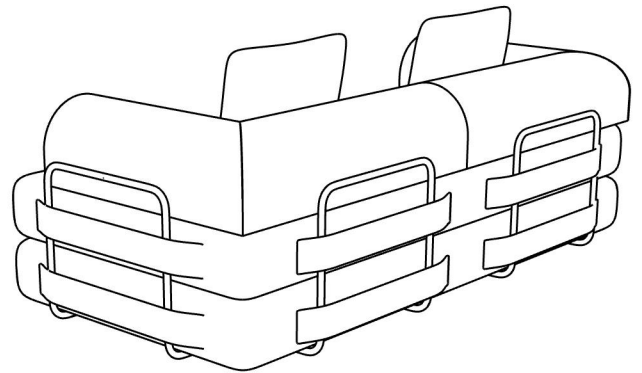
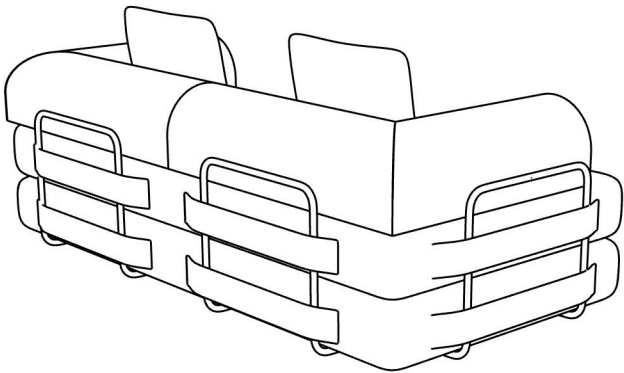

## ASSEMBLY INSTRUCTION

**STEP5:**Lazy sofa form.

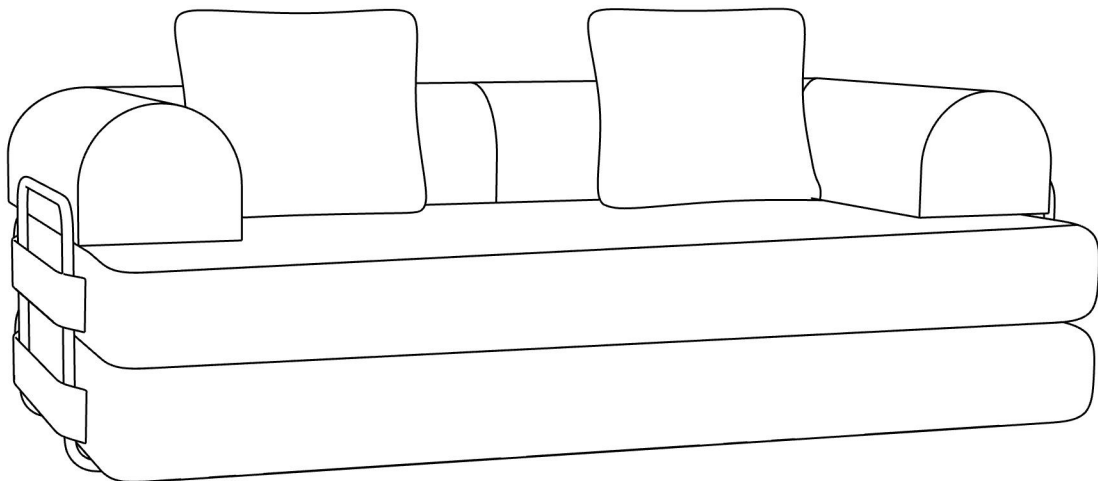

**COMPLETE!**

## Attention

When you find wrinkles on the sofa, you can use a steam electric iron (set to no more than 212°F) to smooth them out. Below is an example for reference.

