

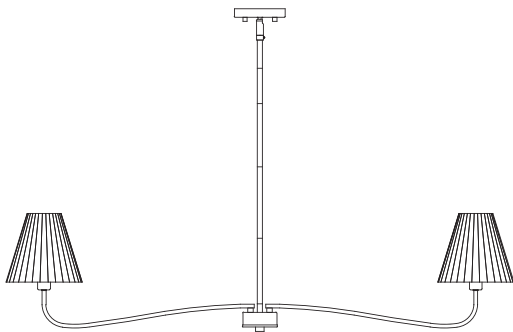

Chandeliers

SKU: HCDL15A
[Instruction Manual]



Please pay attention to the warning signs
Read the instructions with caution before operating
and keep it properly

Warning:

Risk of fire. Min 167°F/75°C supply conductors. Consult a qualified electrician to ensure correct installation. Before installation, please turn off the main power of the circuit breaker to prevent possible electric shock.

Installation Instructions

FIG.1. Turn the wall switch to the "OFF" position. Depending on which type of fuse box in your home:

FIG.2. Either turn the main (Master) switch to the "OFF" position to cut off the power supply of the entire home, or turn off the individual switch that supplies power to where the fixture will be installed.

OR

FIG.3. Either turn the main (Master) switch to the "OFF" position to cut off the power supply of the entire home, or unscrew the fuse that supplies power to where the fixture will be installed.

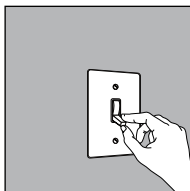

FIG.1 WALL SWITCH

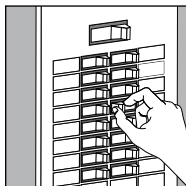

FIG.2 BREAKER PANEL

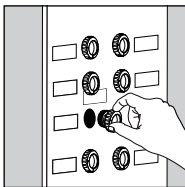
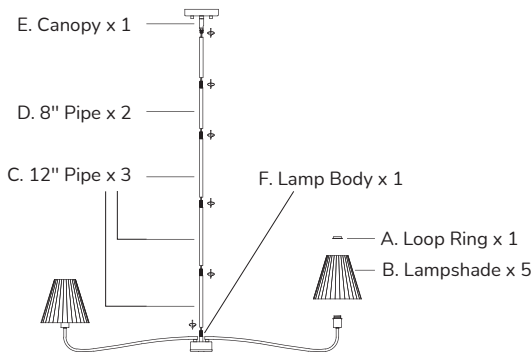







FIG.3 FUSE BOX

PACKING LIST



1. Pass the power cord of Lamp Body (F) through 12" Pipe (C), 8" Pipe (D) and Canopy (E).
2. Tighten the ends of the Pipe (C/D) with Lamp Body (F) and Canopy (E).
3. Put the Lampshade (B) part onto the lamp cup of F, and then use Loop Ring (A) to tighten and fix Lampshade (B) at the lamp cup position.

INSTALLATION KIT

<p>AA x1</p>  <p>Mounting Bracket</p>	<p>BB x2</p>  <p>Mounting Bracket Screw</p>	<p>CC x1</p>  <p>Ground Screw</p>	<p>DD x3</p>  <p>Wire Nut</p>
<p>EE x2</p>  <p>Knurled Nut</p>			

1. Ground Screw (CC) and Mounting Bracket Screw (BB) have been pre-installed on Mounting Bracket (AA).

INSTALLATION

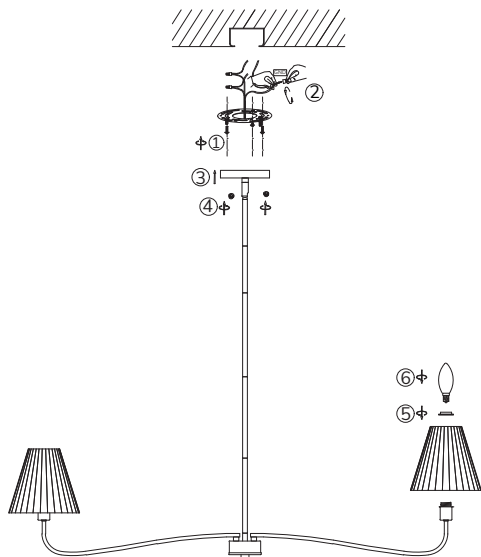

Step 1:

1. Loosen the Knurled Nut (EE) from Canopy (E), and take out the Mounting Bracket (AA).
2. Take off the screws from the outlet box, and secure the Mounting Bracket (AA) onto the box with the screws taken off or Outlet Box Screw (BB).

Step 2:

1. Wrap the ground wire from the outlet box around the Ground Screw (CC) on the Mounting Bracket (AA), and then connect the ground wire from the fixture to the ground wire from the outlet box.
2. Connect the wires from the fixture to the house supply wires, neutral wire (white) to neutral wire, and hot wire (black) to hot wire.
3. Spread apart the wires so that the hot wires are on one side of the

outlet box and the neutral wires are on the other side.

Step 3-4:

Fix the Canopy (E) onto the Mounting Bracket (AA) with the Knurled Nut (EE).

Step 5:

Put the Lampshade (B) part onto the lamp cup of F, and then use Loop Ring (A) to tighten and fix Lampshade (B) at the lamp cup position.

Steps 6:

E12 Bulbs X 5

(Max 40W each, not included)

Specifications

- Input Voltage: 120VAC 60Hz
- Max.load Power: Incandescent Bulb 40w
- Socket Type: Standard Medium E12

One Year Limited Warranty

Supported by our professional R&D team and QC team, we provide One Year Warranty for materials and workmanship from the purchase date. Please note that the warranty does not cover damage caused by personal misuse or improper installation.

Please attach your Order ID and Name so that our dedicated customer service team can help you better.



Made in China