

600w Macerating Toilet System

Product Manual

MT-1



Safety Precautions

Prior to installation, we kindly request you to carefully review the instruction manual.

- If you encounter any difficulties during installation, we recommend consulting a certified plumbing professional for expert assistance.
- Exercise caution while handling heavy components and tools to prevent potential injuries.
- During installation and maintenance, ensure that children are kept away from the toilet area.
- Prevent the entry of chemical solvents, strong acids, and strong alkalines into the machinery.
- The toilet is designed exclusively for sanitary paper, waste, and wastewater disposal. Please refrain from disposing of any other types of waste into the toilet.
- The installation process requires the inclusion of a check valve.
- Maintain a dry environment for the equipment and avoid exposing it to humid conditions.
- Prevent children from interacting with the machinery for safety reasons.
- Maintenance should only be carried out by qualified professionals.
- Install outlets with Ground Fault Circuit Interrupter (GFCI) protection and ensure proper grounding.
- Discharge pipe insert the check valve is only 3/10~7/10inch, avoid too much insert which could result in insufficient air flow and interfere with pumping.

Should you have any inquiries or concerns, please don't hesitate to reach out to our customer support department or consult a certified plumbing expert.

Product List

Pump Accessories



Inlet cover x2

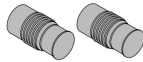

Attachment Fitting x2



Cover Plate x1



Check valve elbow assembly x1



Stainless Steel Screws x2

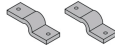

Floor Fitting x2



32-50 Hose Clamps x7



90-100 Hose Clamps x1

Toilet Accessories



Toilet Bowl x1

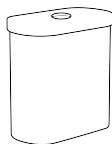

Water Tank x1

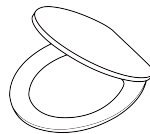

Soft-Close Seat x1



Water Fittings x1

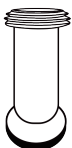

Extension Pipe x1



Macerating Pump x1

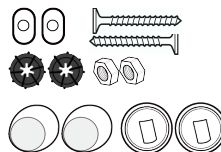

Anchor Bolts x1

After-Sales Support and Appreciation: Our Commitment to Your Satisfaction.

Thank you for choosing our toilet and entrusting us with your bathroom upgrade. As you embark on this journey with our product, rest assured that our commitment to your satisfaction continues beyond your purchase. We value your experience, and we are dedicated to providing exceptional after-sales support.

- **Expert Assistance:** Your satisfaction is paramount to us. If you encounter any challenges during installation or usage, our professional after-sales support team is ready to help you. Contact us for prompt and accurate guidance tailored to your needs.
- **Swift Resolutions:** In the unlikely event that you face any issues with your toilet, we are here to address them swiftly. Our technical experts are equipped to diagnose and provide solutions efficiently, ensuring minimal disruption to your routine.
- **Warranty Protection:** Your peace of mind is paramount. Our products come with a comprehensive warranty, with a 2-year warranty on the toilet and a one-year warranty on the macerator pump. In the event of any manufacturing defect, we stand by our products and work hard to resolve the issue, ensuring your satisfaction is always our top priority.
- **Maintenance Guidance:** Proper maintenance is key to prolonging your toilet's life. Our included maintenance guide offers step-by-step instructions to help you keep your toilet in optimal condition. Maximize performance and enjoy long-lasting reliability.

- **Feedback-Driven Improvements:** Your feedback drives our growth. Your insights, suggestions, and experiences help us refine our products and services. Through your engagement, we continuously enhance our offerings to better cater to your needs.
- **Genuine Parts Availability:** Should you ever require replacement parts, we offer genuine components to ensure seamless integration and continued performance. Our commitment to quality extends beyond the initial purchase.

Appreciation and Gratitude

We extend our heartfelt gratitude for choosing our toilet. Your decision underscores our shared commitment to quality, innovation, and a better bathroom experience. As you embark on this journey with our product, remember that you are not just a customer but a valued member of our community.

We are here to support you every step of the way. Your satisfaction is our success, and we are dedicated to exceeding your expectations. Thank you once again for choosing our product. We look forward to accompanying you on this remarkable journey of comfort, convenience, and excellence.

Problems you may encounter

- **In-wall Installation:** If you choose to install the macerator pump inside the wall, be sure to leave an access opening to allow for easy inspection and repair in the event of any problems.
- **Extension Pipe Connection:** If you need to connect an extension pipe, it is recommended that the length of the connection does not exceed 31-1/2 inches. If the extension exceeds 11-4/5 inches, adding a slope to ensure that water can flow into the unit quickly.

- **Leakage from Extension Pipe:** If you notice leakage at the green end of the extension pipe connection, please contact us, and we will replace the extension pipe for you. If leakage occurs at the other end, check that the hose clamp connection is correct.
- **Vent Pipe Connection:** You have the option to connect or not connect the vent pipe, but we do not recommend connecting it to avoid potential issues. The product comes equipped with activated carbon cotton and generally odorless. If you must connect the vent pipe, make sure the diameter of the pipes is larger than the vent outlet and minimize the length of the pipe and bends in the pipe to prevent airflow obstruction.
- **Water Supply Pipe Size:** Compatible water supply pipe size is approximately 3/4 inches; please use 3/4-inch fittings.
- **Flushing Issues:** If you encounter problems with the toilet not flushing, you can open the maintenance port at the top of the pump to check for any obstructions inside. If you find any blockages, please clear them and then attempt to flush the toilet again to confirm if the issue has been resolved.
- **Continuous Pumping/Backflow of Sewage:** Check if a bend pipe is installed (this should not be the case). Please install the check valve provided with our product. Ensure the check valve is not inserted too deeply to prevent air intake issues.
- **Toilet Damage:** In case of damage to the toilet, please contact us, and we will provide a replacement or a full refund as a solution.

Pump Installation

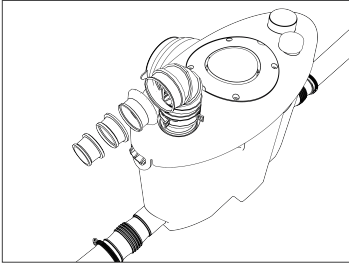

- 1 You can tailor the attachment fitting attached to the maceration pump's inlet and the check valve elbow assembly on the outlet to be compatible with your specific pipe dimensions.

(If one of the inlet ports is not needed, you can use an inlet cover for effective sealing.)

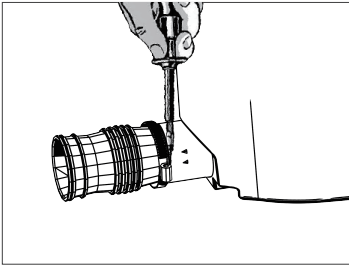

- 2 Insert the attachment fitting into the maceration pump water inlet and secure it in place using a hose clamps.

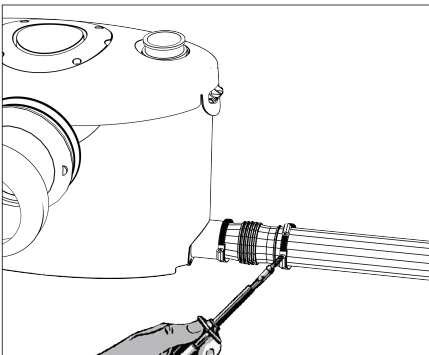
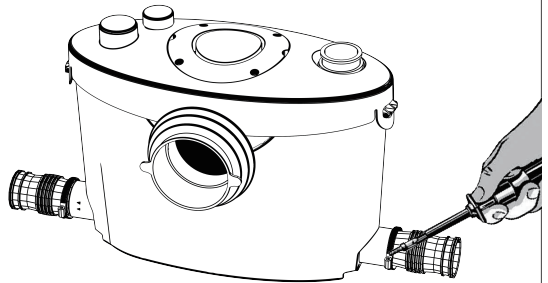

- 3 Connect the household water pipe to the other end of the attachment fitting pipe and secure it with a hose clamps.

Pump Installation

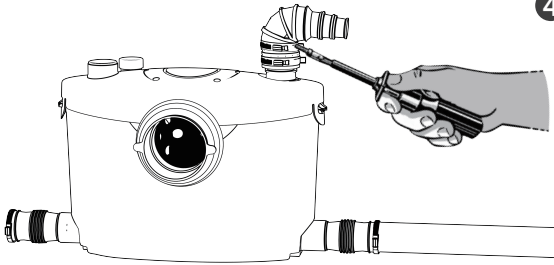

- 4 Start by placing the hose clamps at the outlet, then insert the black end of the check valve elbow assembly into the outlet and secure it in place using hose clamps.

- 5 Connect the household water pipe to the other end of the attachment fitting pipe and secure it with a hose clamps.

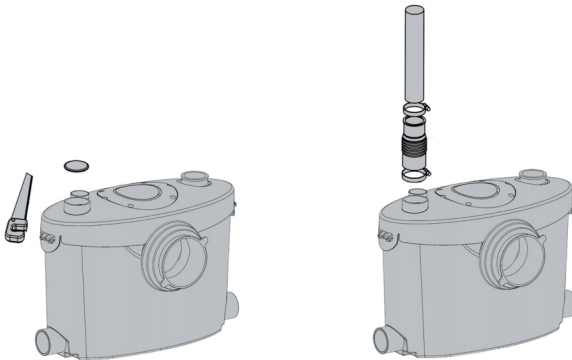
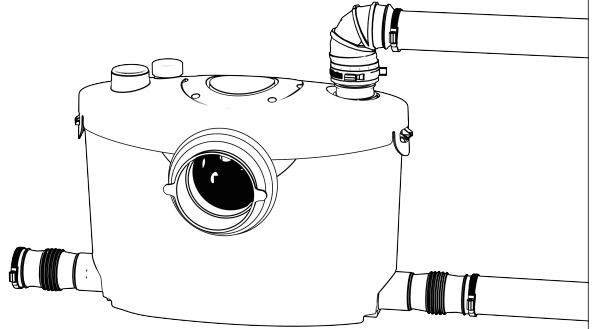

Our maceration pump have built-in vents with activated charcoal filters and are equipped with activated charcoal pads, with the option of using activated charcoal pads or connecting the vent to your home ventilation system for odor control.

Toilet installation

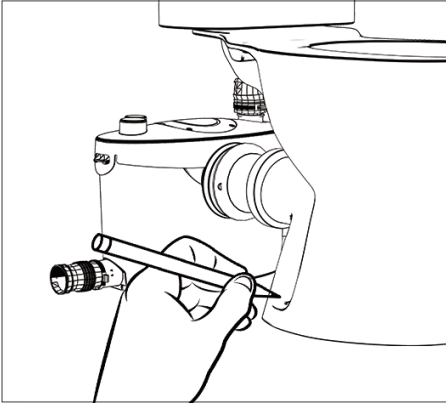

- 1 Confirm the precise toilet installation position and indicate the spots on either side of the toilet's base using a pen.

- 2 Shift the toilet away, confirm the marked spots, and utilize an electric drill to make two small holes.

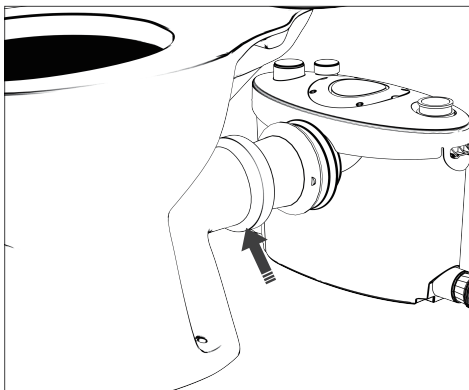
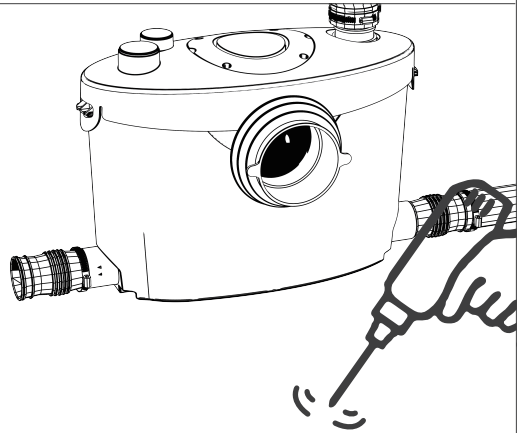

- 3 Align the toilet with the rear outlet and place it in the desired position.

Toilet installation

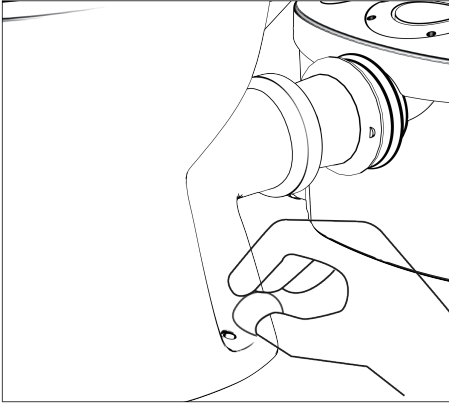

- 4** Put the screws into the small holes on both sides of the bottom of the toilet, and tighten it with the screws to secure it, then put the screw caps on.

- 5** Join the toilet's rear outlet and the maceration pump using an extension pipe, and then fasten them securely using a hose clamps.

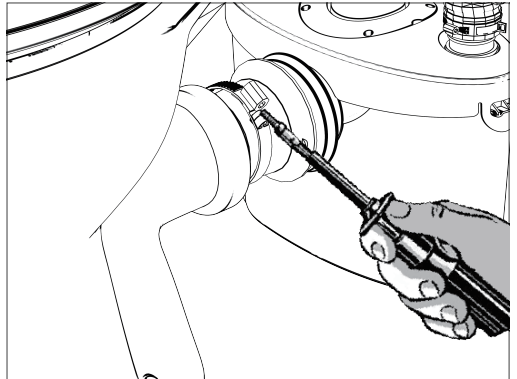

Toilet installation

Two installation methods



1

Behind the toilet



2

Behind the Wall

You can flexibility to decide whether to install the macerating pump inside the wall or position it behind the toilet, depending on your bathroom's size and your personal preferences.

Toilet tank installation

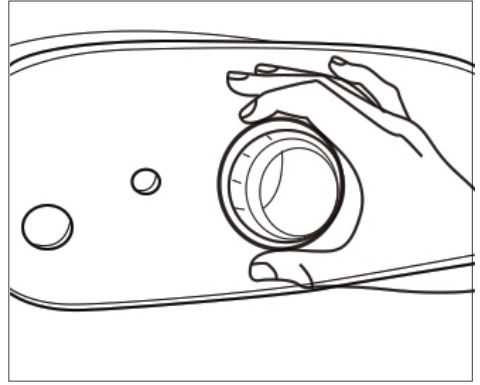
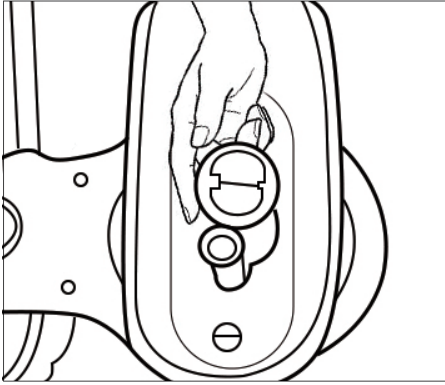

- 1 Place the flush valve into the corresponding hole in the tank, making sure it is properly aligned. Also, place the tank gasket over the tank nut ensuring there are no gaps between the gasket and the chinaware.

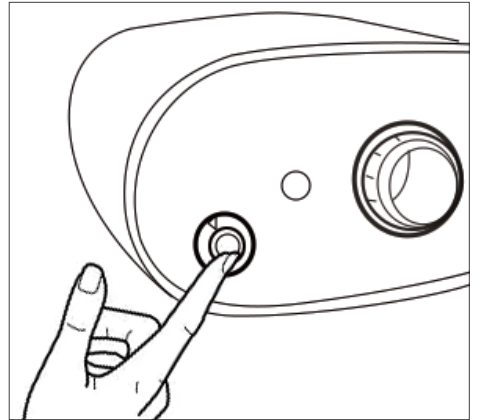
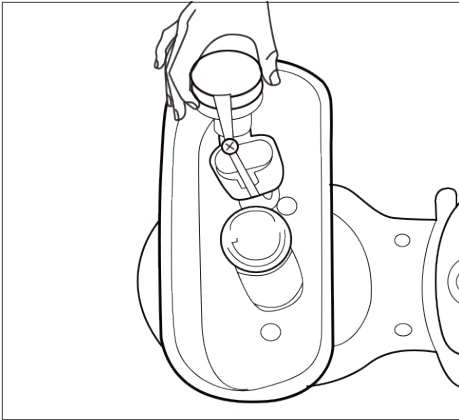

- 2 Place the water inlet valve into the corresponding hole in the water tank, making sure it is properly aligned, and tighten the bolts.

Toilet tank installation

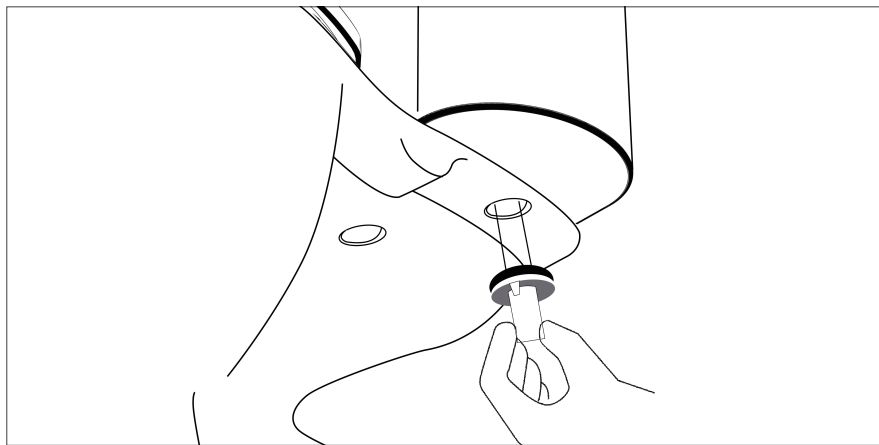

3 Secure the tank and toilet together using two bolts.

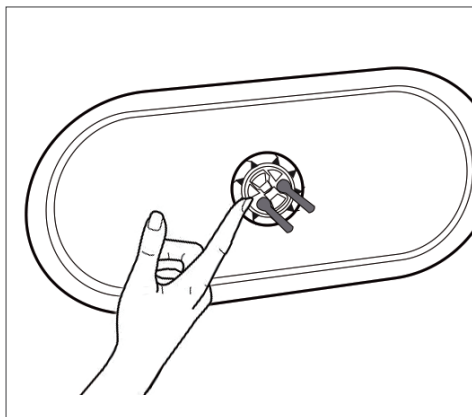
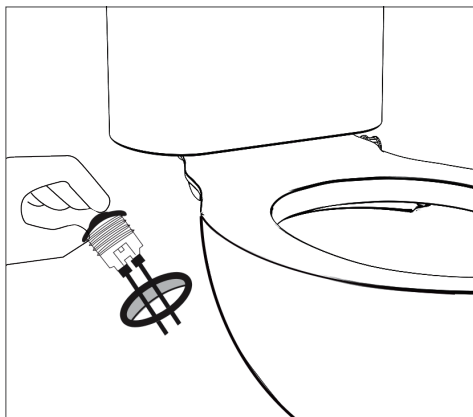

4 Thread the button through the tank cover and secure it in place using the provided component.

Toilet seat installation

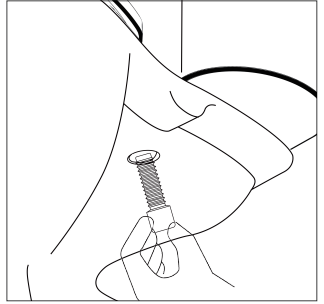
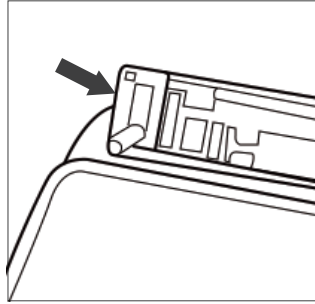
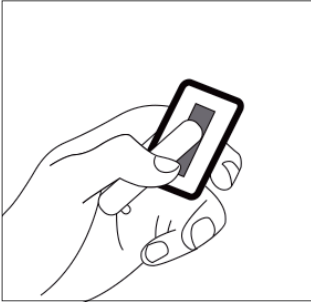

- 5** Insert the screws into the plate and slide the plate with screws to the mounting tracks, then insert the toilet seat into the seat holes and lock the seat with the nut.

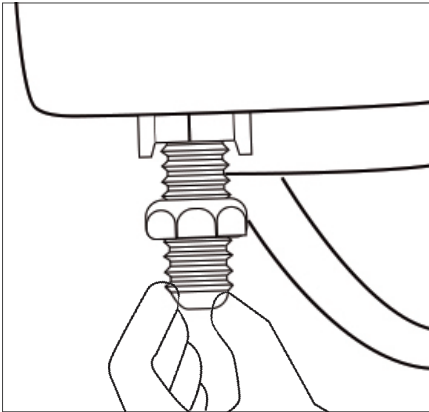

- 6** Water supply hose:
Simply connect the water supply hose to the inlet valve adapter.

WARNING:

line nuts could result in breakage and Overtightening of water supply potential flooding. If the connection leaks after hand tightening, replace the supply line. Do not use any type of sealant on the water supply connection. Use of plumber's putty, pipe dope, or any other type of sealant will void the warranty.

Thank you for your choice and trust

- Thank you for choosing our toilet products. At the end of this toilet manual, we would like to express our deepest gratitude. Your trust and support are the driving force behind our continuous efforts to improve and provide quality products.
- We understand that choosing the right toilet is an important decision, and your choice of us means you trust us. Our team puts a lot of effort into product design, manufacturing and service, aiming to provide you with an outstanding experience and long-lasting quality.
- Whether it's your first time using a two piece toilet or you're already a longtime user, we want you to feel the convenience, comfort, and quality you've come to expect from our products. If you have any questions or need assistance during the use process, our customer service team is ready to provide you with support and guidance.
- Thank you again for choosing our products. We look forward to bringing you more great experiences and providing you with continued quality service. We wish you a more convenient and comfortable life!