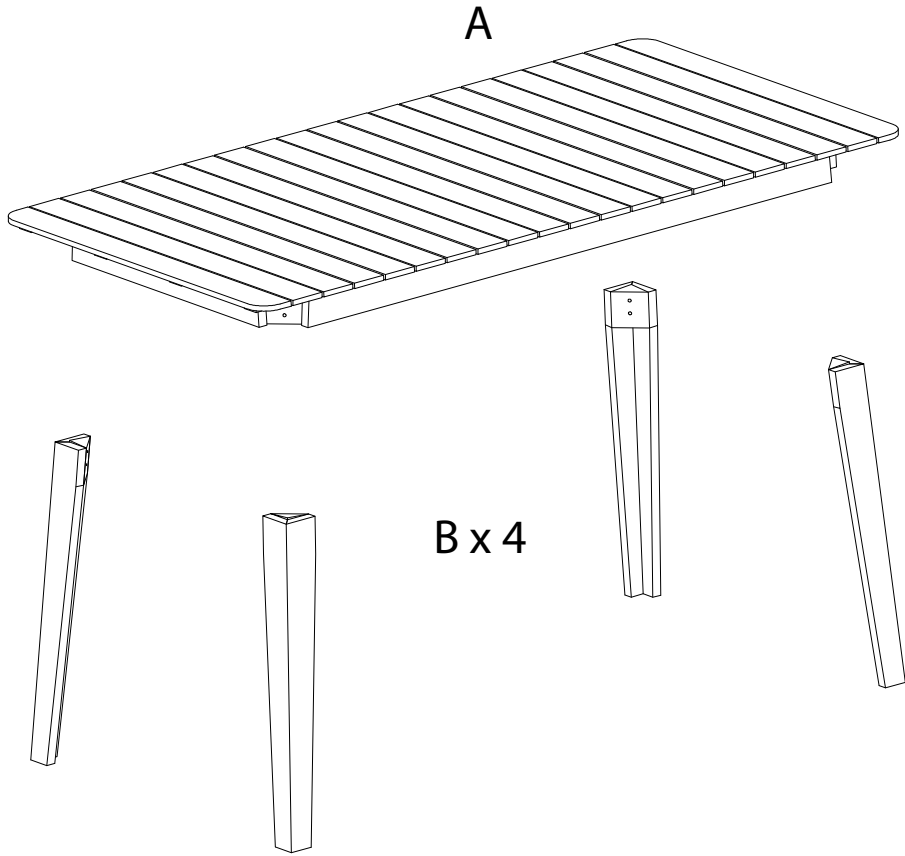
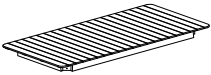

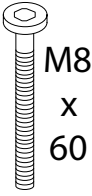
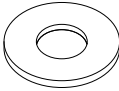
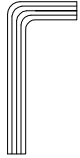





Diagram illustrating assembly instructions and safety warnings:

- Top Section:** Shows an L-shaped bracket being inserted into a hole in a wooden piece. A power drill is shown with a slash through it, indicating that a power drill should not be used for this step. A warning triangle with an exclamation mark is positioned to the right.
- Bottom Section:** Shows a wooden block being placed on a surface. A power drill is shown with a slash through it, indicating that a power drill should not be used for this step. A warning triangle with an exclamation mark is positioned to the right.
- Time:** A clock icon is shown, indicating a 10-minute assembly time.
- Personnel:** A person icon is shown, indicating that 2 people are required for assembly.



A	B	C	D	E
		 <p>M8 x 60</p>		
x 1	x 4	x 8	x 8	x 1

1

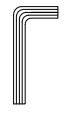
<p>A</p>  <p>x 1</p>	<p>B</p>  <p>x 4</p>	<p>C</p>  <p>M8 x 60 x 8</p>	<p>D</p>  <p>x 8</p>	<p>E</p>  <p>x 1</p>
---	---	---	---	---

