

ASSEMBLY INSTRUCTIONS

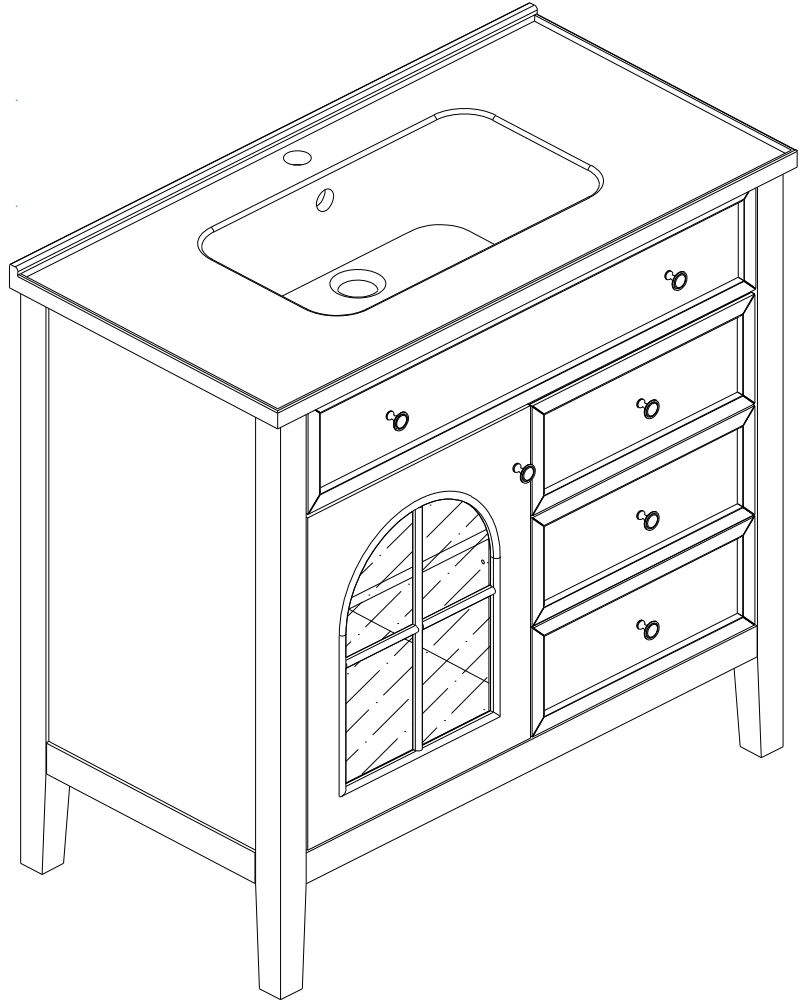

Notice:

1. Follow the installation instructions. Please confirm all accessories are preset before installation.
2. Do not fully tighten the screws during initial assembly. Fully tighten screws only once all pieces which are correctly assembled.
3. If you encounter any problems during installation, please contact our customer service.
4. Please unbox the item from the side with an open-label and put a carpet on the floor to avoid scratching it.

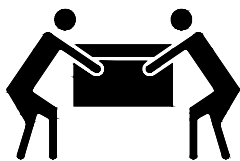

Recommended installers:2

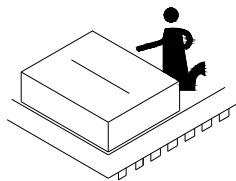

Put a carpet on the floor
before unpacking

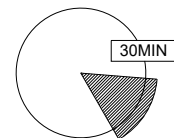

Estimate installation time:
30minutes

ASSEMBLY INSTRUCTIONS

PART LIST

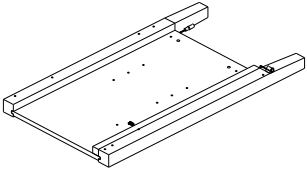
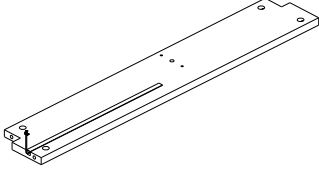
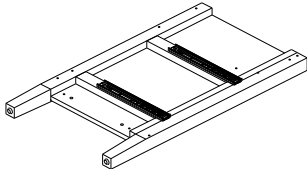
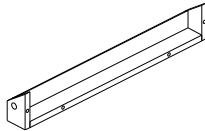
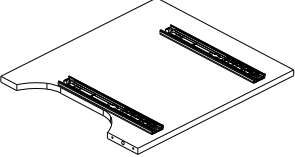
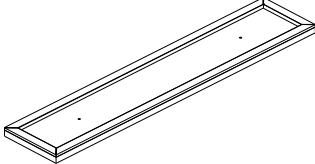
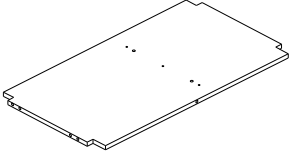
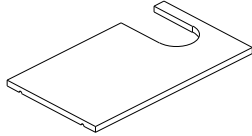
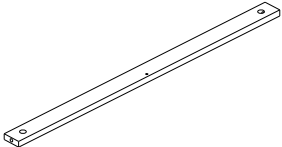
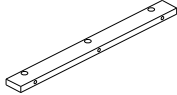
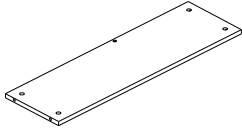
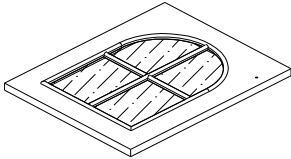
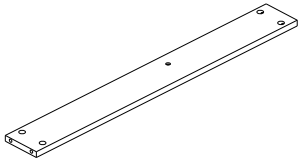
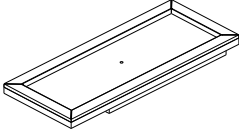
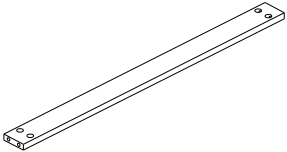
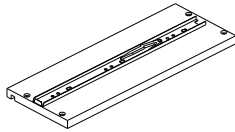
Item no.	Reference Image	Qty	Item no.	Reference Image	Qty
(A)		X1	(I)		X1
(B)		X1	(J)		X1
(C)		X1	(K)		X1
(D)		X1	(L)		X1
(E)		X1	(M)		X1
(F)		X1	(N)		X1
(G)		X1	(O)		X1
(H)		X1	(P)		X1





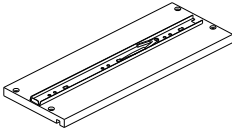
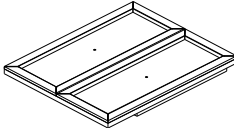
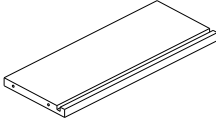
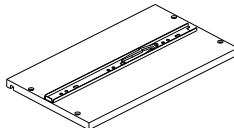
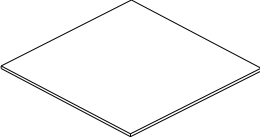
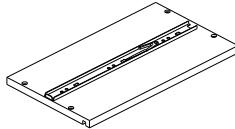
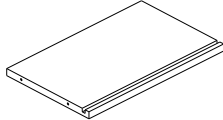



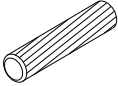
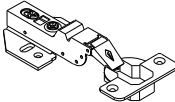

ASSEMBLY INSTRUCTIONS

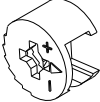
PART LIST

Item no.	Reference Image	Qty		Item no.	Reference Image	Qty
Q		X1		T		X1
R		X1		U		X1
S		X2		V		X1
				W		X1

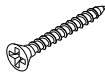
ASSEMBLY INSTRUCTIONS

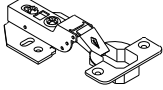
HARDWARE LIST

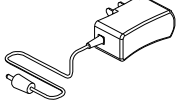
Item no.	Reference Image	Qty	Item no.	Reference Image	Qty
1	 Ø8*30mm	X9	7		X2
2		X30+3	8	 Ø3*14mm	X24+2
3		X30+3	9		X4
4	 Ø3.5*50mm	X4	10		X6
5	 Ø3.5*30mm	X18+1	11	 Ø5*3/4"	X6
6		X2	12		X1
			13		X1

ASSEMBLY INSTRUCTIONS

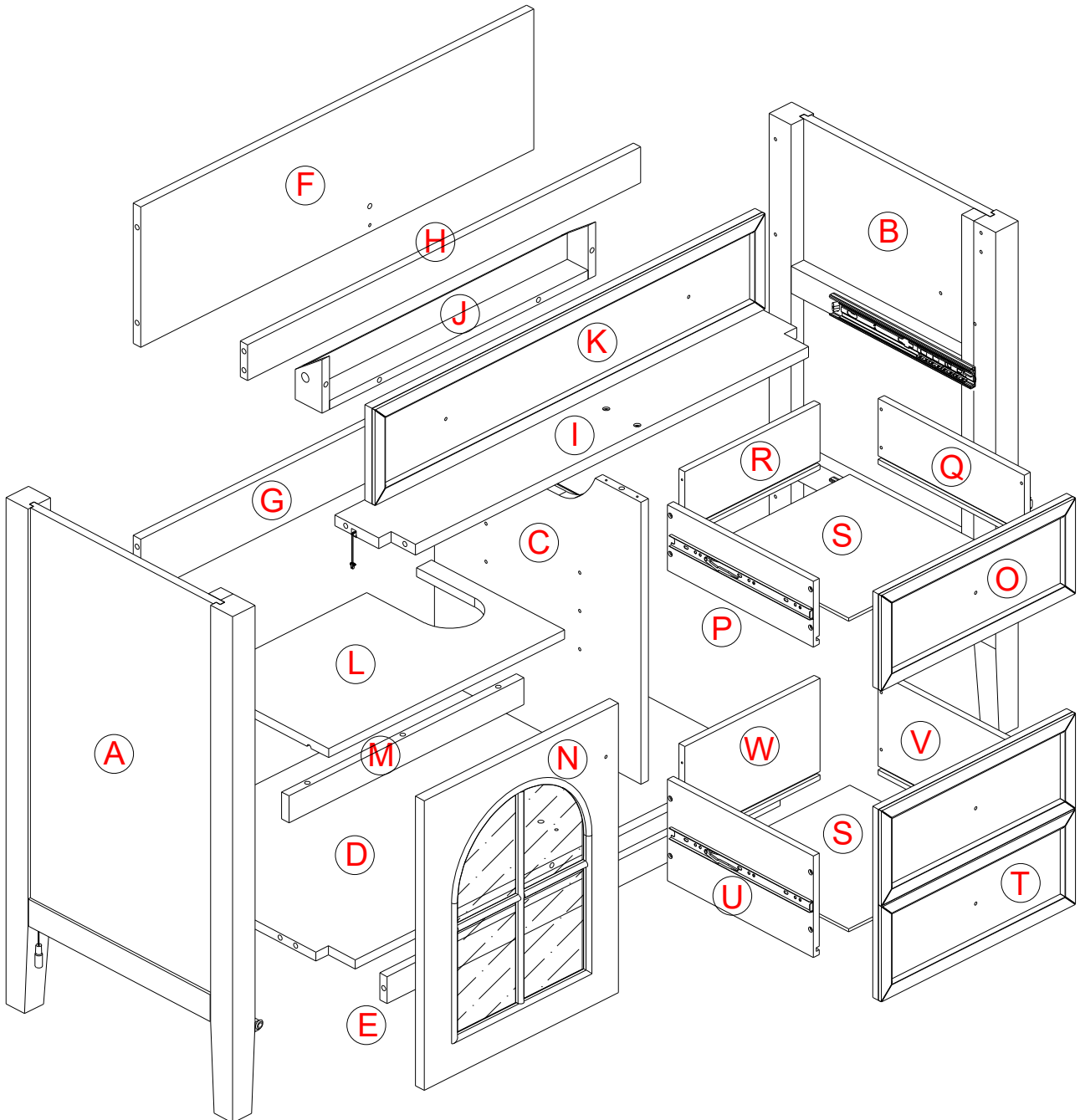

ASSEMBLY INSTRUCTIONS

1

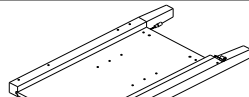

(A) 1PC

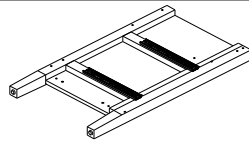

(B) 1PC



(2) 22PCS

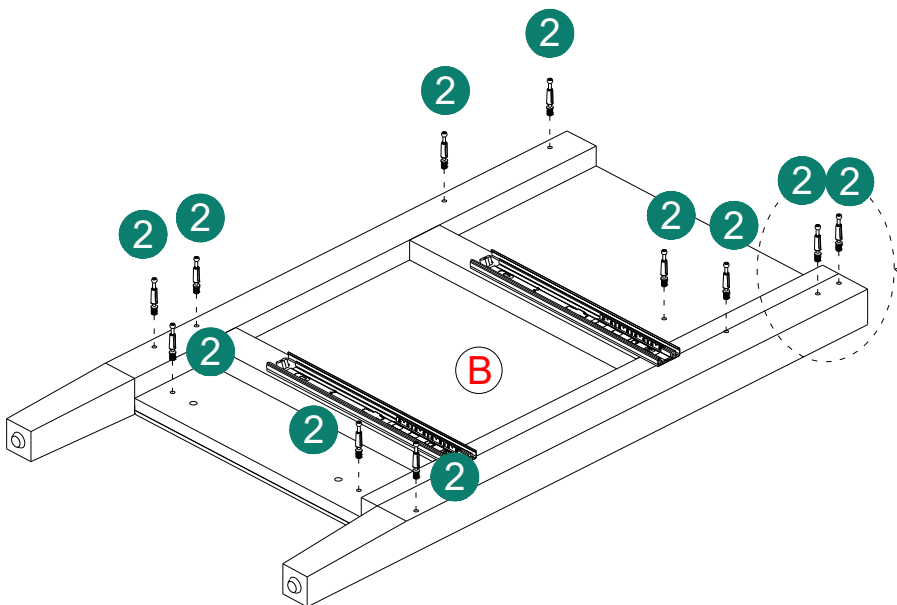
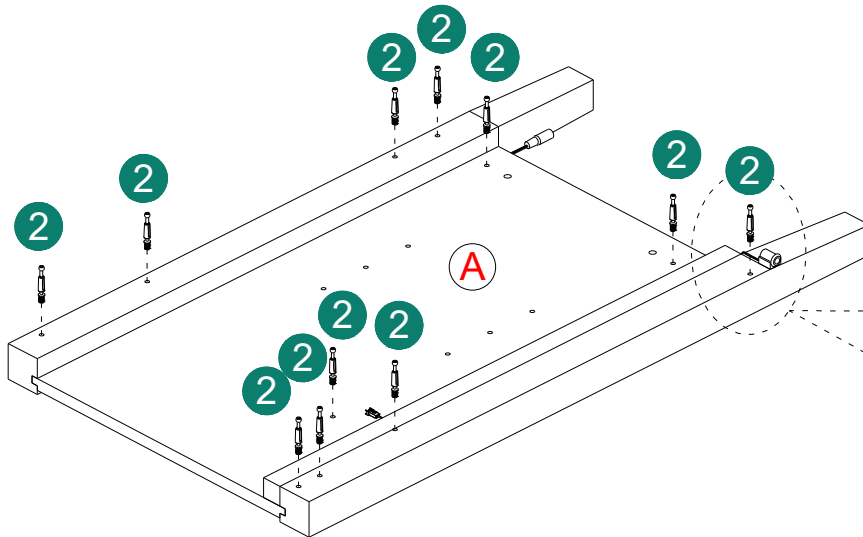

ASSEMBLY INSTRUCTIONS

2

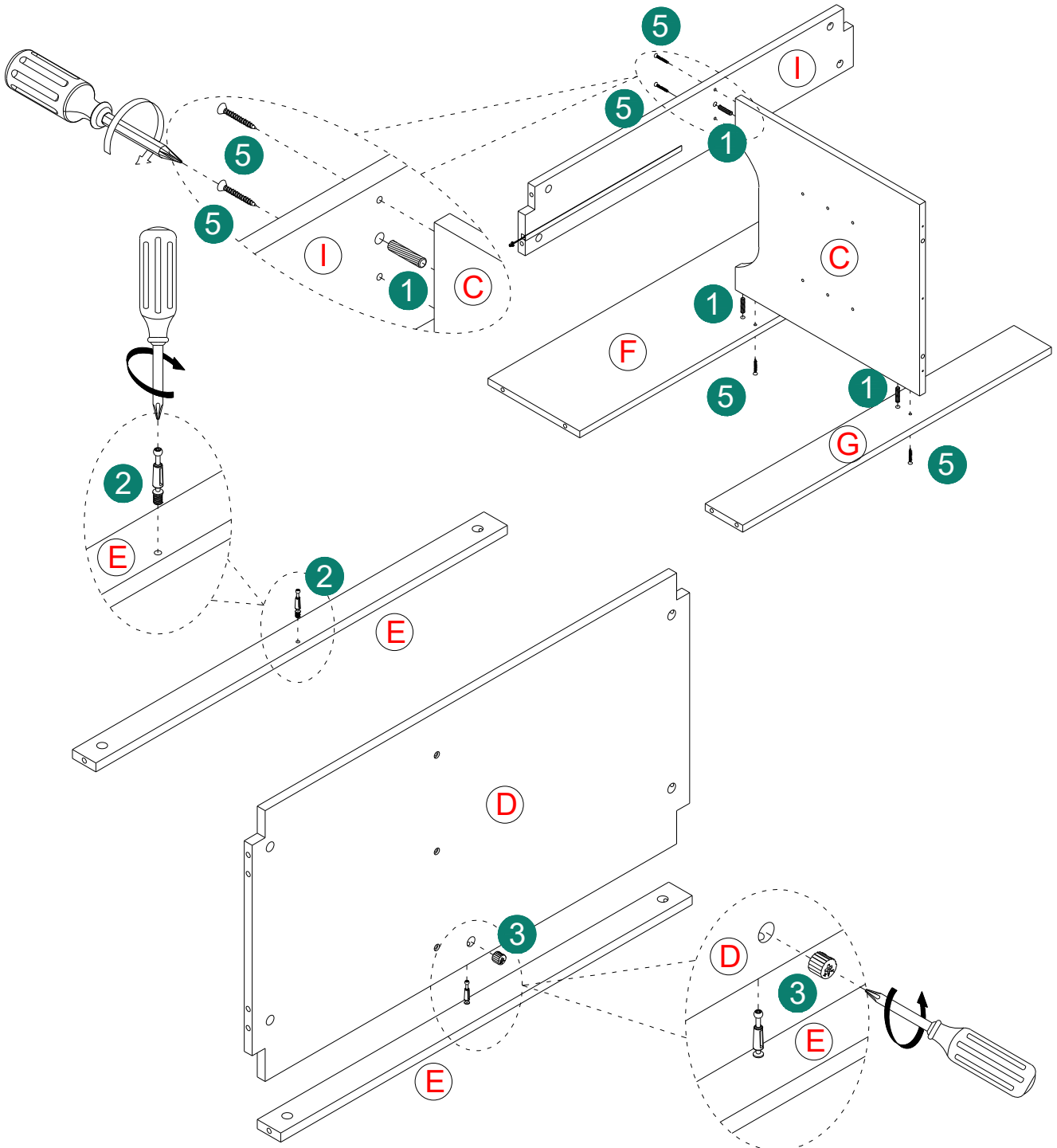
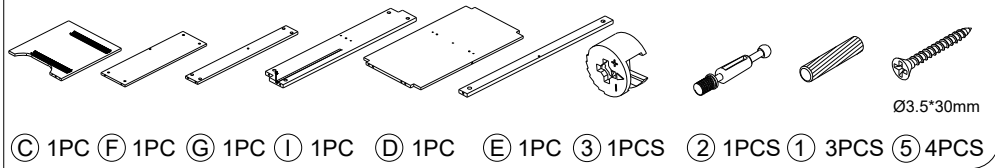

ASSEMBLY INSTRUCTIONS

3

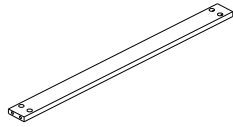

H 1PC



Ø3.5*50mm

4 3PCS



3 11PCS

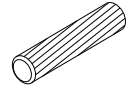

1 4PCS

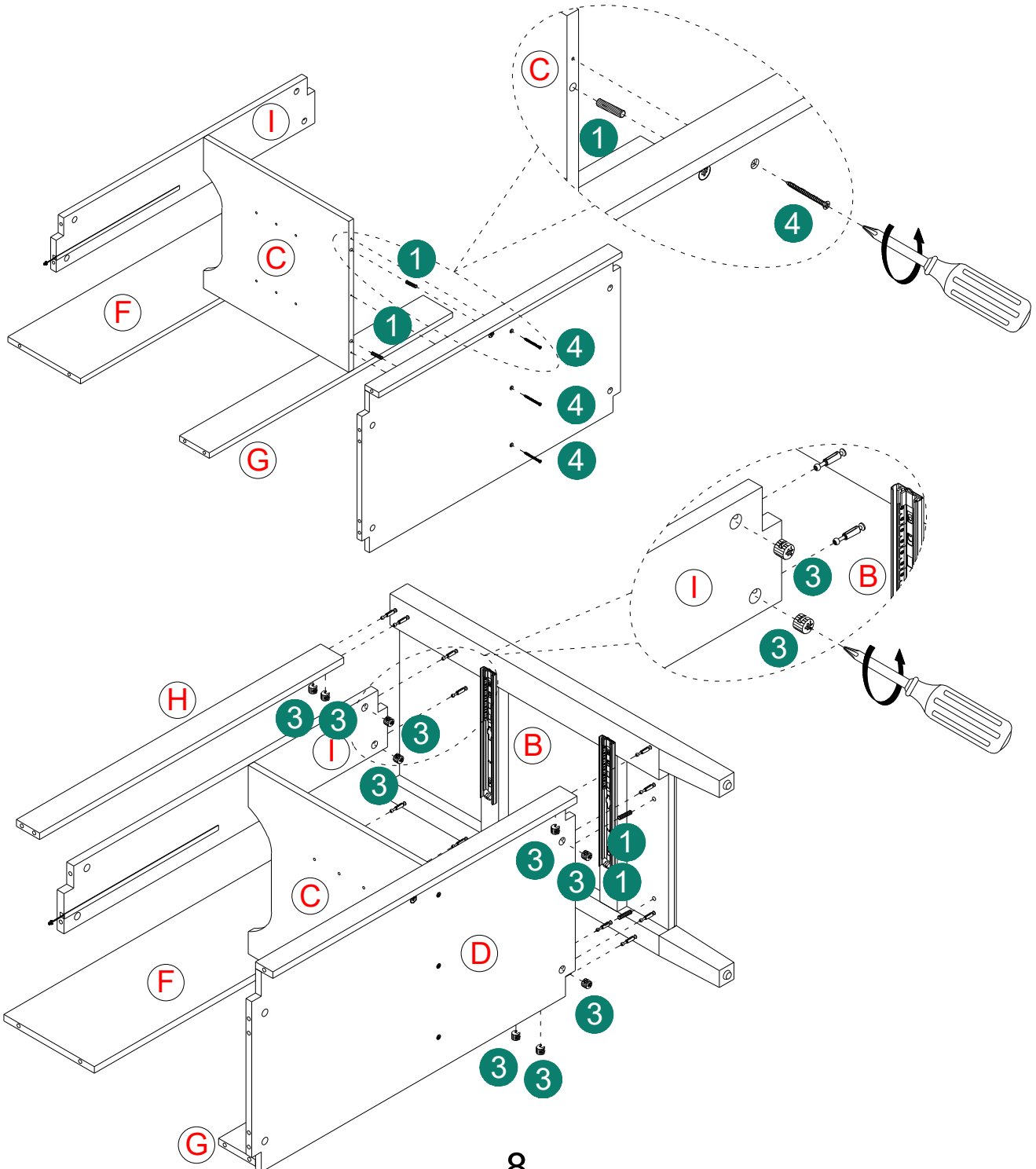

ASSEMBLY INSTRUCTIONS

4

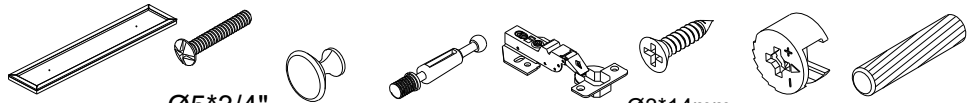

Ø5*3/4"

Ø3*14mm

(K) 1PC (11) 2PCS (10) 2PCS (2) 4PCS (7) 2PCS (8) 4PCS (3) 11PCS (1) 2PCS

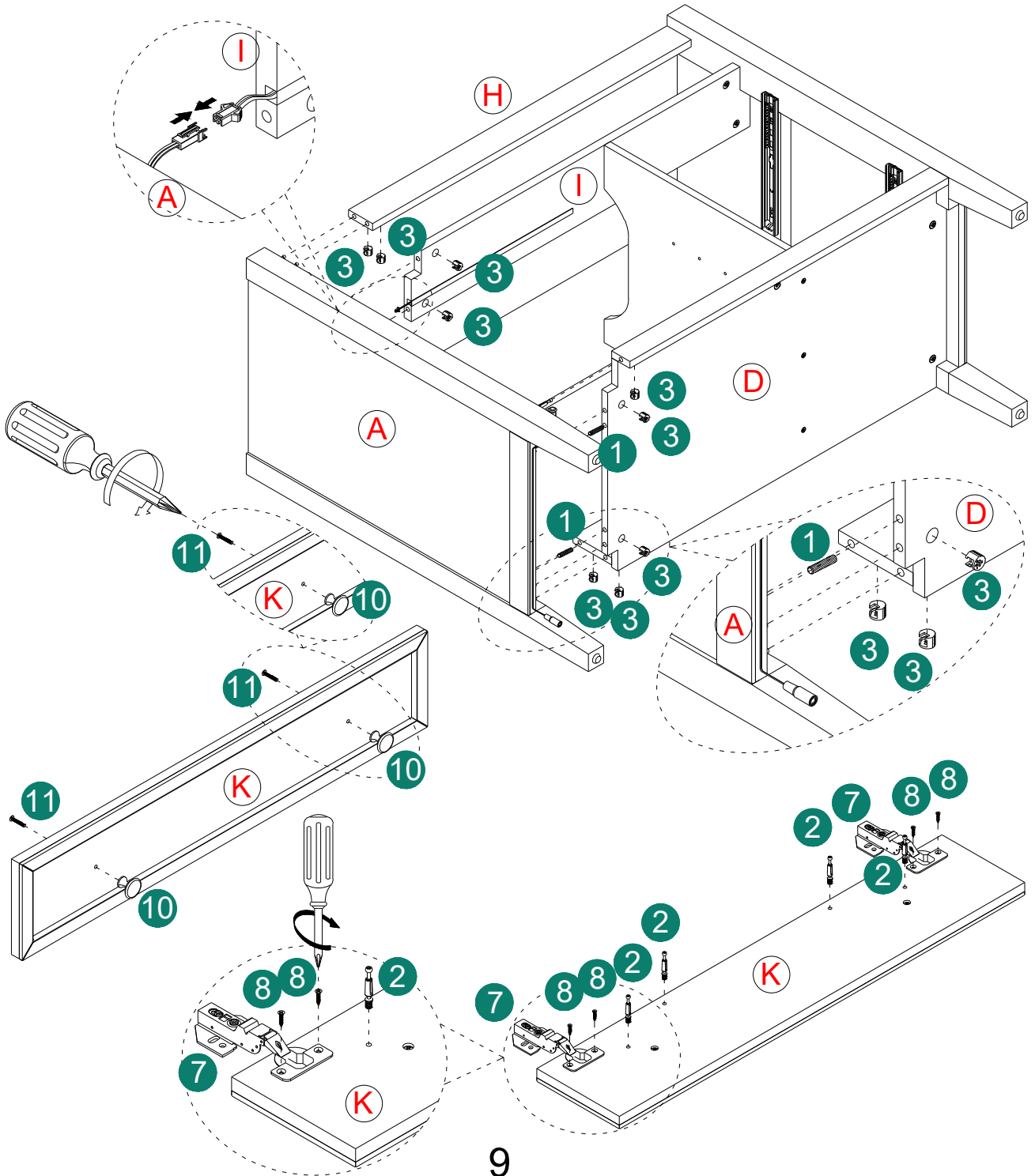

ASSEMBLY INSTRUCTIONS

5

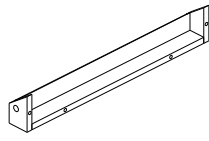

J 1PC



Ø3*14mm

8 8PCS



3 4PCS

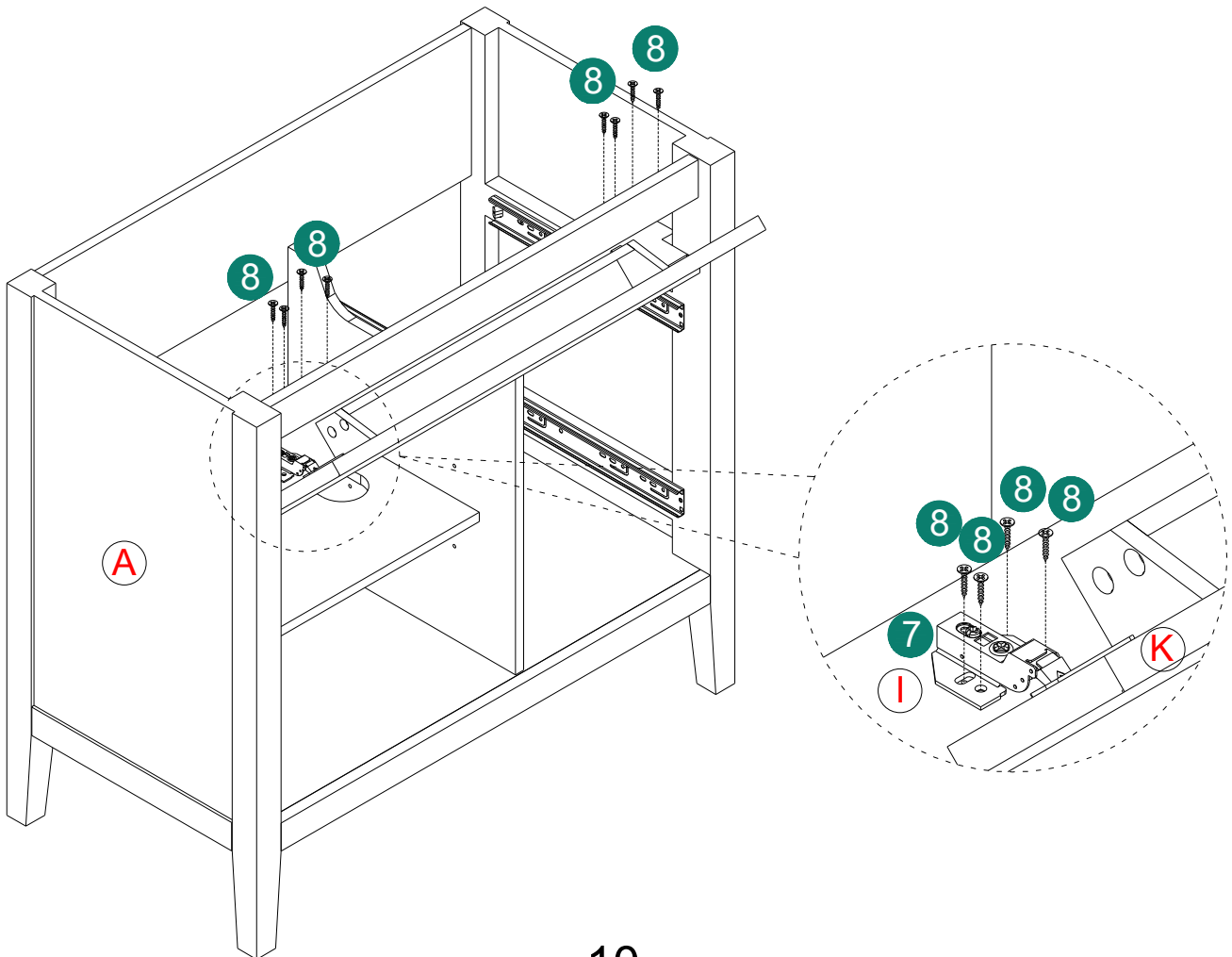
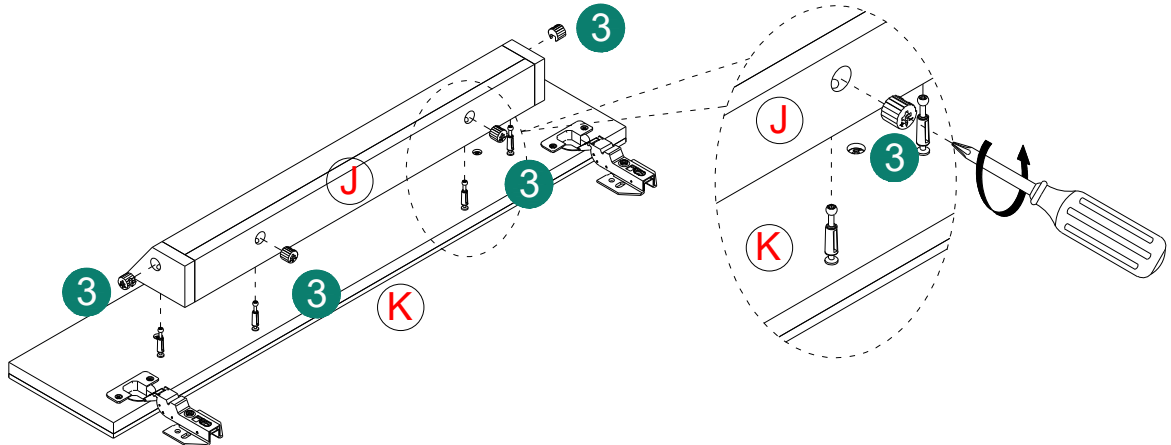

ASSEMBLY INSTRUCTIONS

7

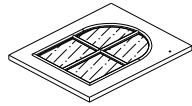

(N) 1PC



Ø5*3/4"

(11) 1PCS



(10) 1PCS

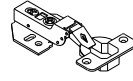

(6) 2PCS



Ø3*14mm

(8) 4PCS



(12) 1PCS

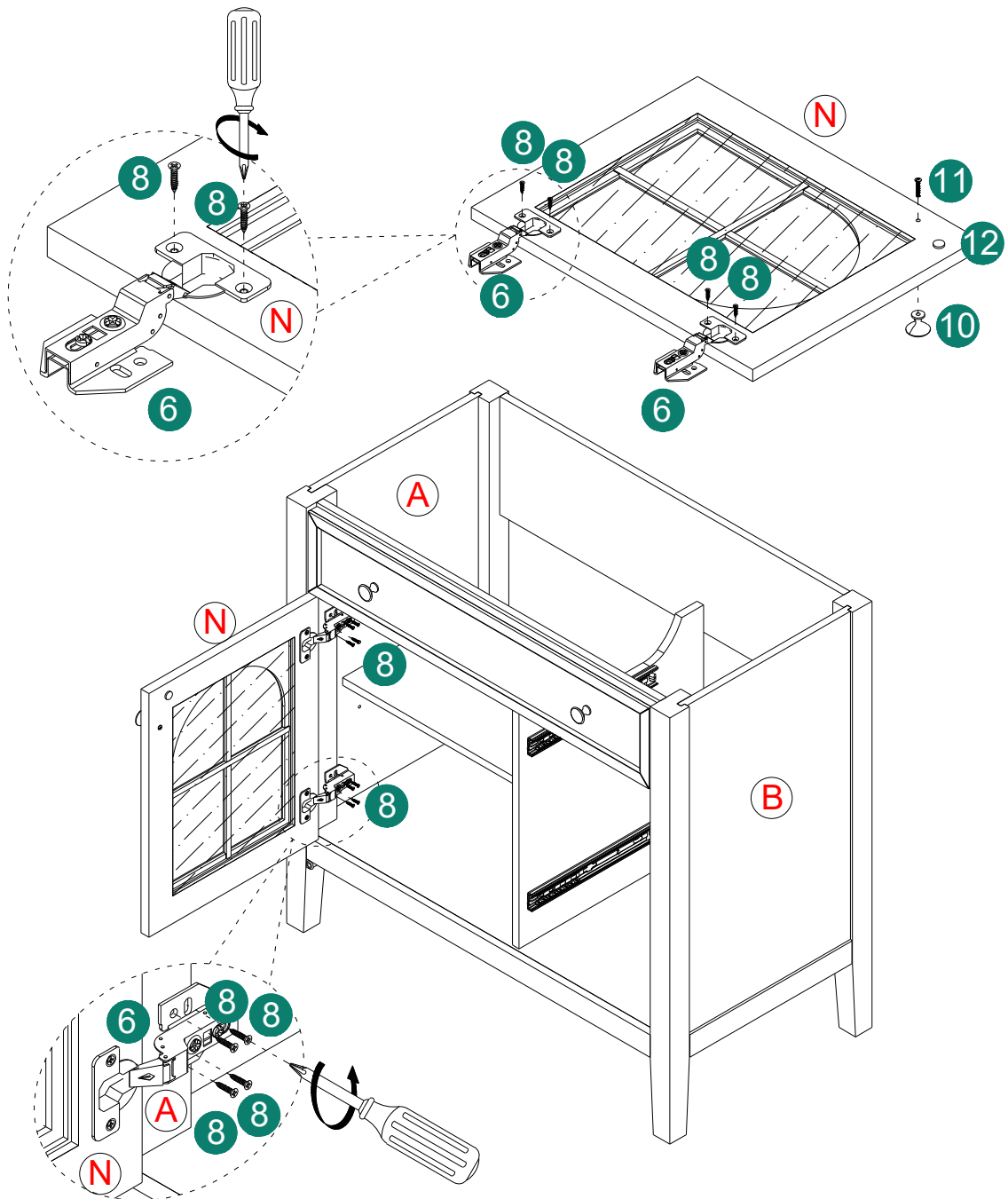

ASSEMBLY INSTRUCTIONS

8

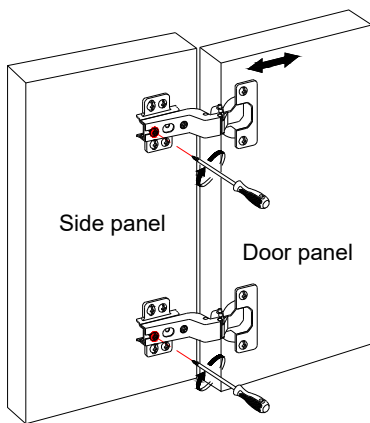

1

Front-to-Back Direction Adjustment:

Rotate the screws on the door hinges shown in the image. The door panel can be moved front-back.

Adjustment range: 4mm

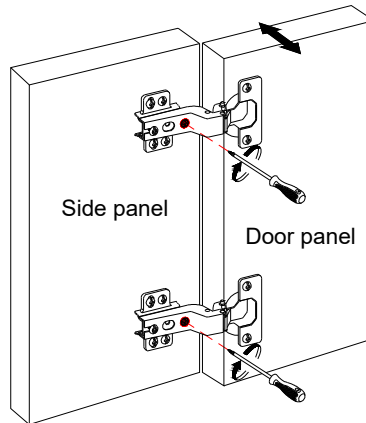

2

Left-Right Direction Adjustment:

Rotate the screws on the door hinges shown in the image. The door panel can be moved left-right.

Adjustment range: 3mm

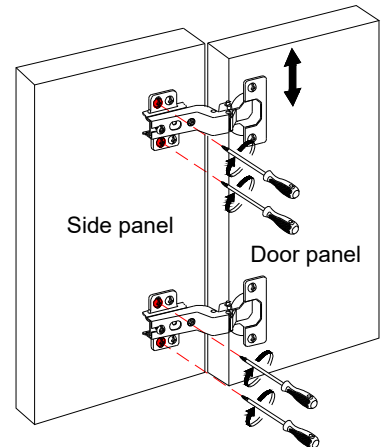

3

Up-Down Direction Adjustment:

Rotate the screws on the door hinges shown in the image. The door panel can be moved up-down.

Adjustment range: 4mm

ASSEMBLY INSTRUCTIONS

9

Common Door Panel Issues:

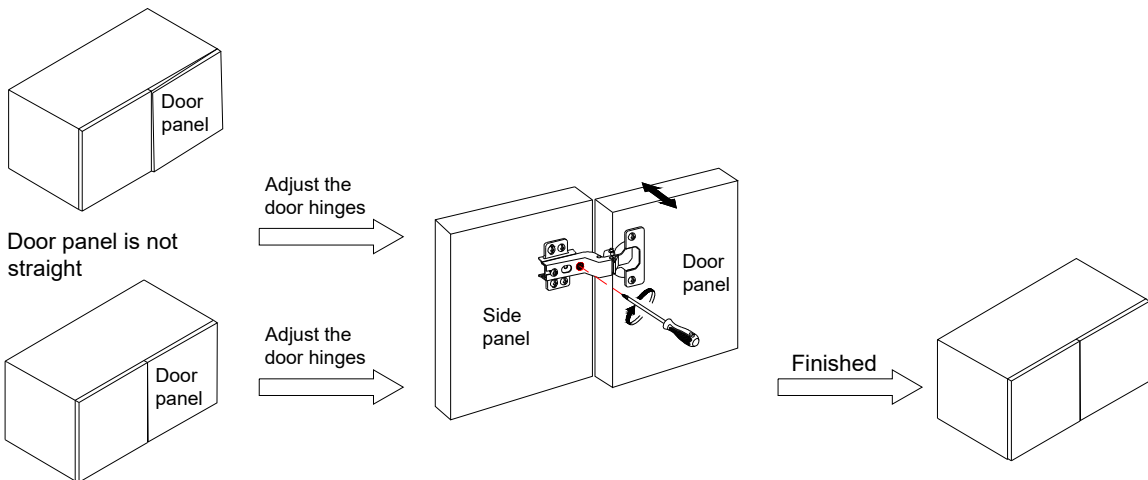

The gap between door panels is too large

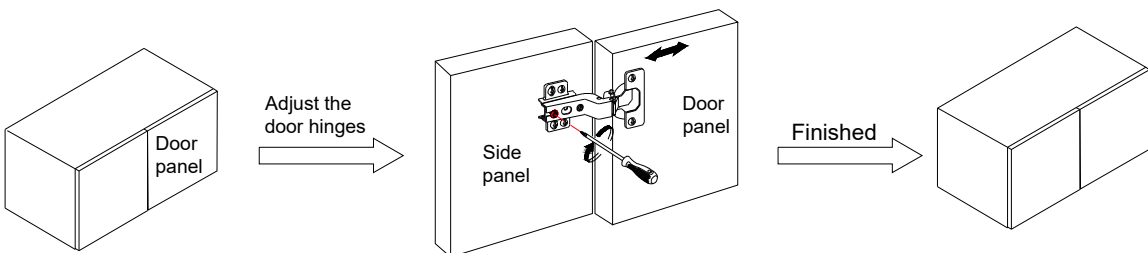

The door panels are not coplanar

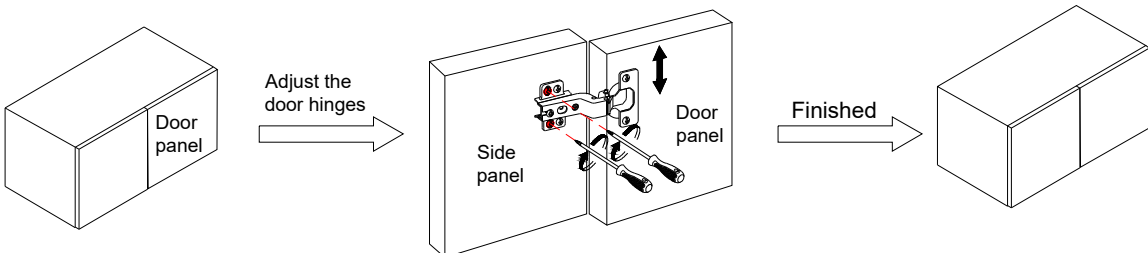

The two door panels are not at the same height

ASSEMBLY INSTRUCTIONS

11

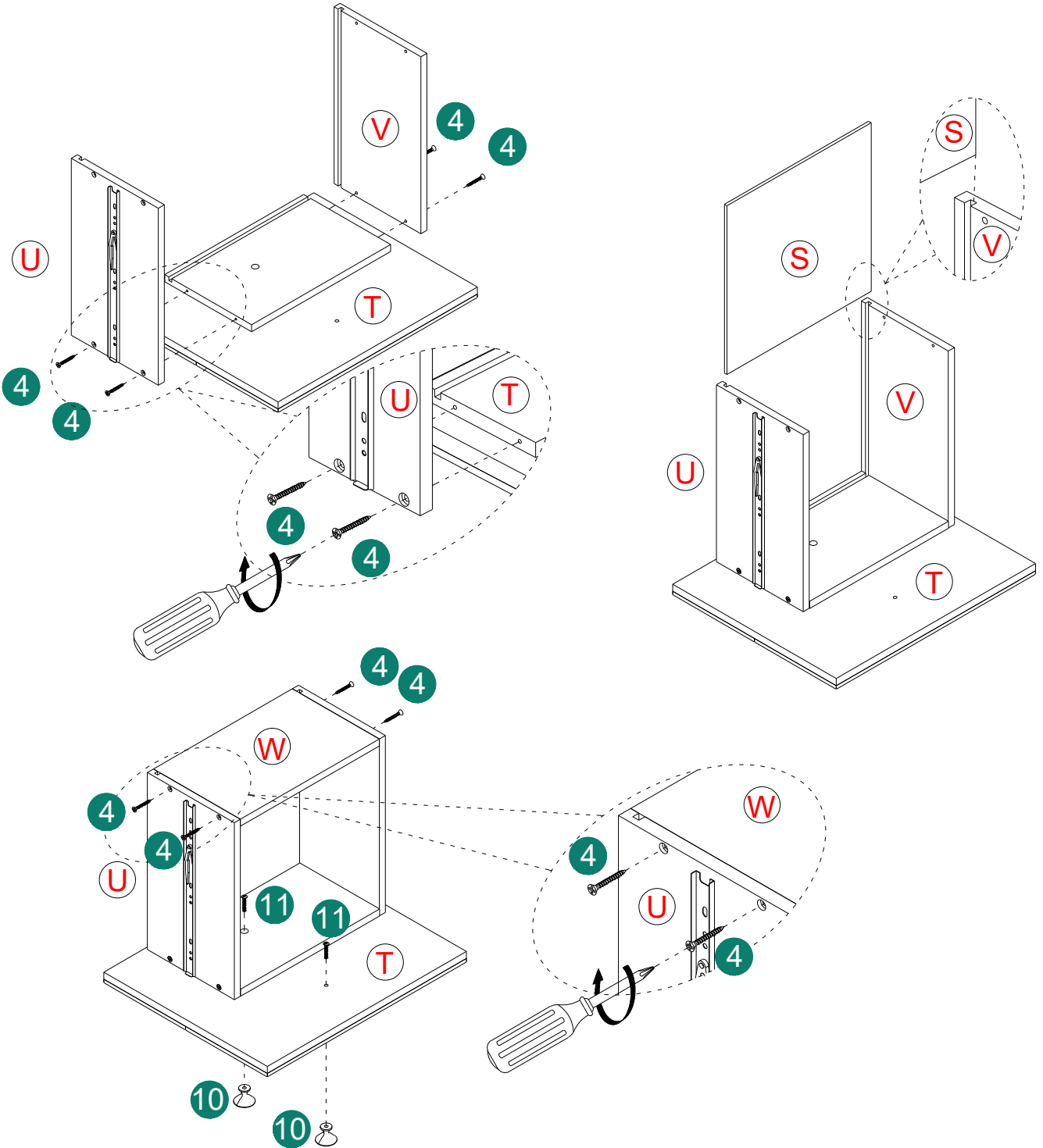
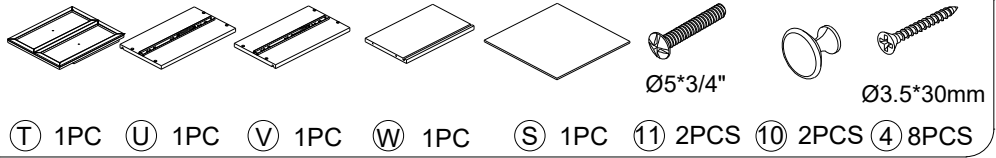

ASSEMBLY INSTRUCTIONS

12

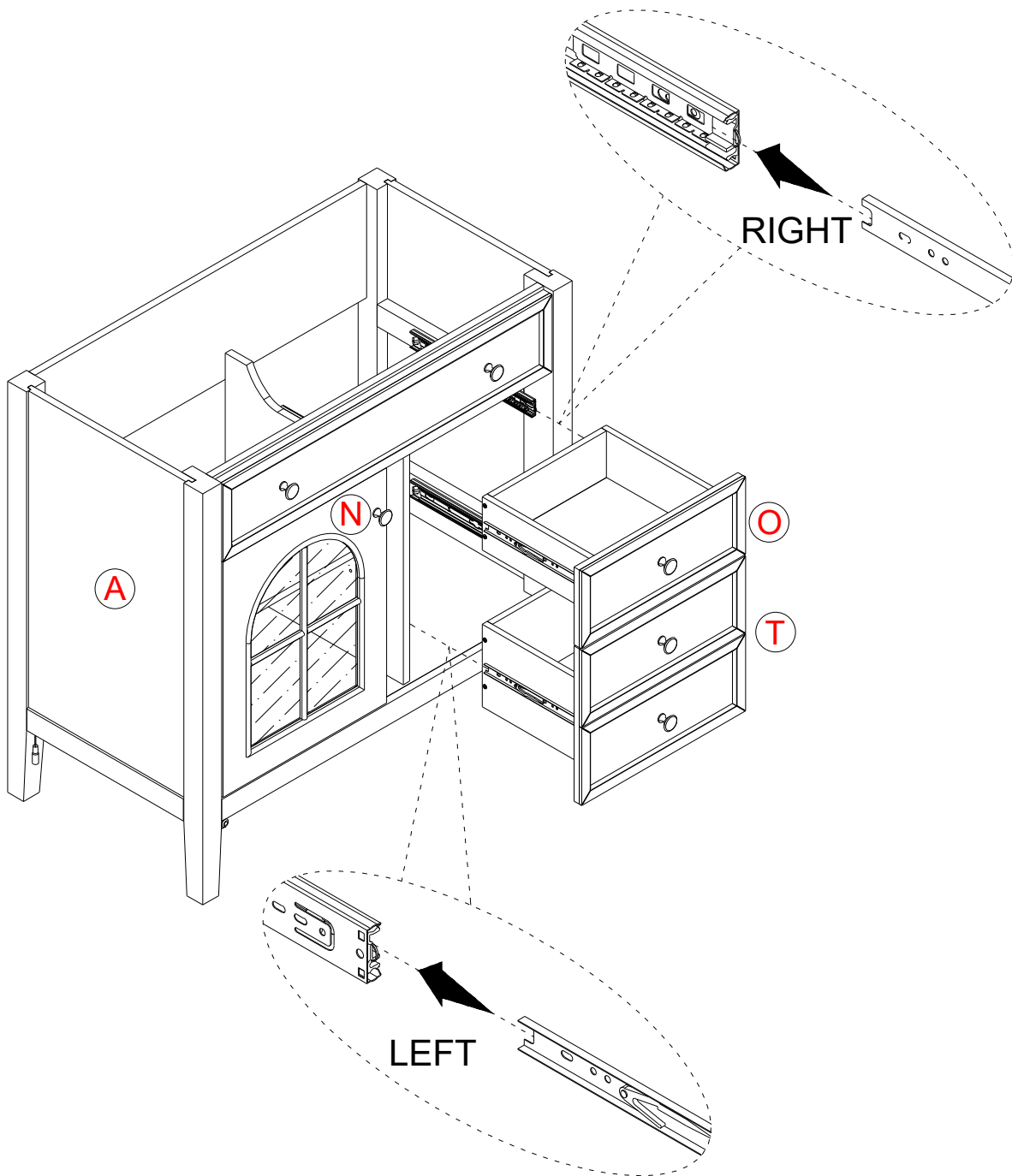

ASSEMBLY INSTRUCTIONS

13

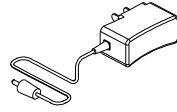

13 1PCS

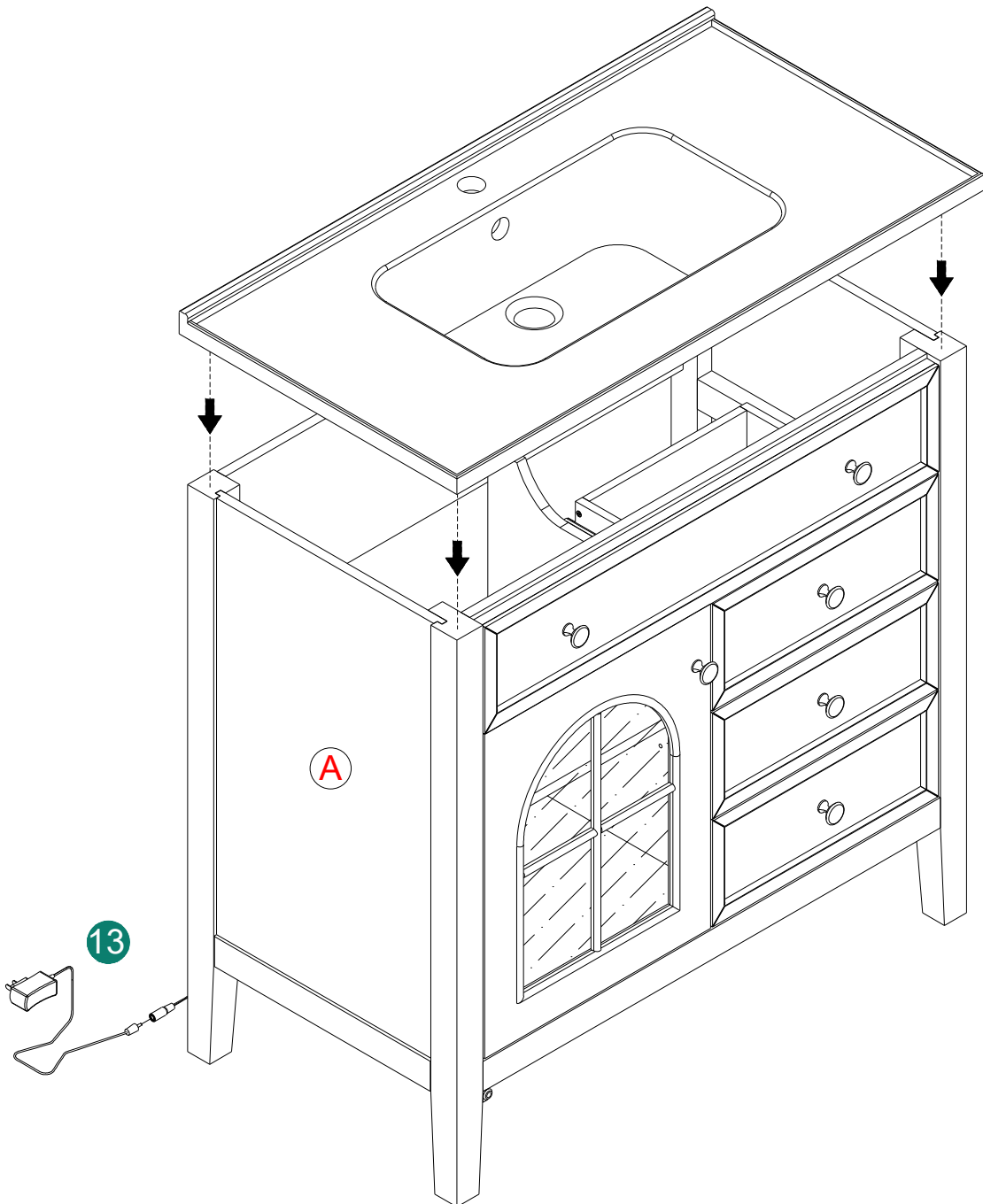

18