

Thank you for purchasing Integrated LED Lighting Fixtures!

TROUBLESHOOTING:

- Check that line voltage at fixture is correct.
- Ensure that there is voltage at lamp fixture wires. If there is no voltage, then check all connections.
- Check that fixture is grounded properly.

If fixture does not light:

- Check switch to ensure that there are no defects.
- Check fuse/circuit breaker for trips, then check wiring connections.

CLEANING AND MAINTENANCE:

CAUTION: Ensure fixture temperature is cool enough to touch. DO NOT clean or perform maintenance while fixture is energized.

- Clean lens and fixture with non-abrasive cleaning solution.
- Do not open fixture to clean LED. Do not touch the LED.
- Do not spray liquid directly on to LED, LED driver or wiring.







Please read carefully before installing fixture.

Save these instructions, as you may need them at a later date.

Please follow the following steps for installation. →

Edson LED Outdoor Sconce

WARNINGS:

-  Turn power off before installation, inspection, or removal. Use all necessary precautions while performing this procedure.
-  Consult a qualified electrician to ensure correct branch circuit conductor. Min 90°C supply conductors.
-  Properly ground electrical enclosure. IT IS IMPERATIVE THAT THE OUTLET BOX BE PROPERLY GROUNDED.
-  DO NOT REVERSE THE HOT AND NEUTRAL CONNECTIONS, OTHERWISE SAFETY WILL BE COMPROMISED.
-  This Integrated LED Fixture™ has no lamp/bulb to replace.
-  Do not open the glass or touch inside the LED chip board.

GENERAL: All electrical connections must be in accordance with local and National Electrical Code (N.E.C.) standards. If you are unfamiliar with proper electrical wiring connections, contact and obtain the services of a qualified electrician. Use UL or IEC approved wire only for input/output connections.

Remove fixture and mounting components from the box, and make sure that no parts are missing, by referencing the illustration in the illustration instructions.

NOT DIMMING COMPATIBLE: *This product is not compatible with dimmers. Fixture performance could be compromised by wiring fixture with dimmer. DO NOT USE WITH DIMMER(S)!*

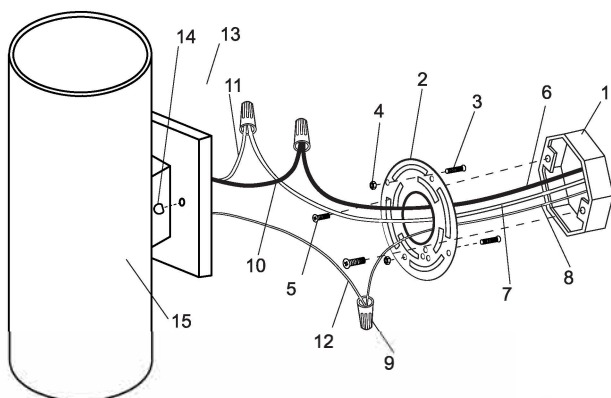

Figure 1

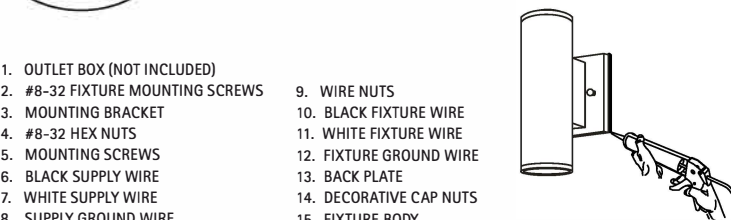

Figure 2

- 1. OUTLET BOX (NOT INCLUDED)
- 2. #8-32 FIXTURE MOUNTING SCREWS
- 3. MOUNTING BRACKET
- 4. #8-32 HEX NUTS
- 5. MOUNTING SCREWS
- 6. BLACK SUPPLY WIRE
- 7. WHITE SUPPLY WIRE
- 8. SUPPLY GROUND WIRE
- 9. WIRE NUTS
- 10. BLACK FIXTURE WIRE
- 11. WHITE FIXTURE WIRE
- 12. FIXTURE GROUND WIRE
- 13. BACK PLATE
- 14. DECORATIVE CAP NUTS
- 15. FIXTURE BODY

1 SHUT OFF MAIN ELECTRICAL SUPPLY FROM THE MAIN FUSE BOX/CIRCUIT BREAKER!

2 Remove contents from box. Ensure that no parts are missing. Reference the illustration included with this instruction manual.

3 Thread #8-32 FIXTURE MOUNTING SCREWS(2) through the holes in the MOUNTING BRACKET(3).

4 Thread the #8-32 HEX NUTS(4) onto the #8-32 FIXTURE MOUNTING SCREWS(2). Do not tighten the #8-32 HEX NUTS(4) at this time.

5 Locate BLACK AND WHITE SUPPLY WIRES(6&7) and the SUPPLY GROUND WIRE(8), and remove them from the OUTLET BOX(1).

6 Use the included MOUNTING SCREWS(5) to mount MOUNTING BRACKET(3) to the OUTLET BOX (1).

7 Place the FIXTURE BODY(15) over the OUTLET BOX(1) and onto the #8-32 FIXTURE MOUNTING SCREWS(2). Adjust the #8-32 FIXTURE MOUNTING SCREWS(2) until they protrude out from the FIXTURE BODY(13) approx. 1/4".

8 Remove the FIXTURE BODY(15). Then, secure the position of the #8-32 FIXTURE MOUNTING SCREWS(2) by tightening the #8-32 HEX NUTS(4) against the MOUNTING BRACKET(3).

9 Make the following wire connections [Fig.1], using the provided WIRE NUTS(9):
 WHITE (-) SUPPLY WIRE (7) TO WHITE FIXTURE WIRE (11)
 BLACK (+) SUPPLY WIRE (6) TO BLACK FIXTURE WIRE (10)
 SUPPLY GROUND WIRE (8) TO FIXTURE GROUND WIRE (12)
 If necessary, wrap all wire connections in electrical tape to ensure a secure connection.

10 Carefully tuck wire connections back into OUTLET BOX(1).

11 Mount the fixture. Position the BACK PLATE(13) over the OUTLET BOX(1) and feed the #8-32 FIXTURE MOUNTING SCREWS(2) through the corresponding holes until they protrude through the BACK PLATE(13). Secure using the DECORATIVE CAP NUTS(14).

12 For outdoor installation: after mounting the fixture, caulk the upper 2/3 of the surface between the BACK PLATE(13) and the mounting surface. [Fig. 2] Note: Leave the bottom 1/3 uncaulked for drainage. Use caulking material rated for exterior use.

13 Restore power at fuse box/circuit breaker. Check operation of Integrated LED Fixture™.

14 Installation complete.

5-YEAR LIMITED WARRANTY

LIMITED WARRANTY: This fixture is warranted to be free from defects in workmanship and material for up to 5-years. Based upon reasonable household usage, when used in accordance with package and included instructions. If this fixture does not last for the time period guaranteed, manufacturer will send you a replacement fixture upon receipt of the returned fixture, register receipt, and proof of purchase.

We are committed to making high quality products. Returning the fixture will help us monitor and further improve product quality. This replacement is the sole remedy available, and LIABILITY FOR INCIDENTAL OR CONSEQUENTIAL DAMAGES IS HEREBY EXPRESSLY EXCLUDED.

This device complies with Part 15 of the Rules and has been tested and found to comply with the limits for Class B digital device. Operation is subject to the following two conditions: (1) this device may not cause harmful interference, and (2) this device must accept any interference received, including interference that may cause undesired operation. Any changes or modifications not expressly approved by manufacturer could void user's authority to operate the equipment.