

ASSEMBLY INSTRUCTIONS (INSTRUCTIONS DE MONTAGE) 30 INCH BATH VANITY (COMBO)

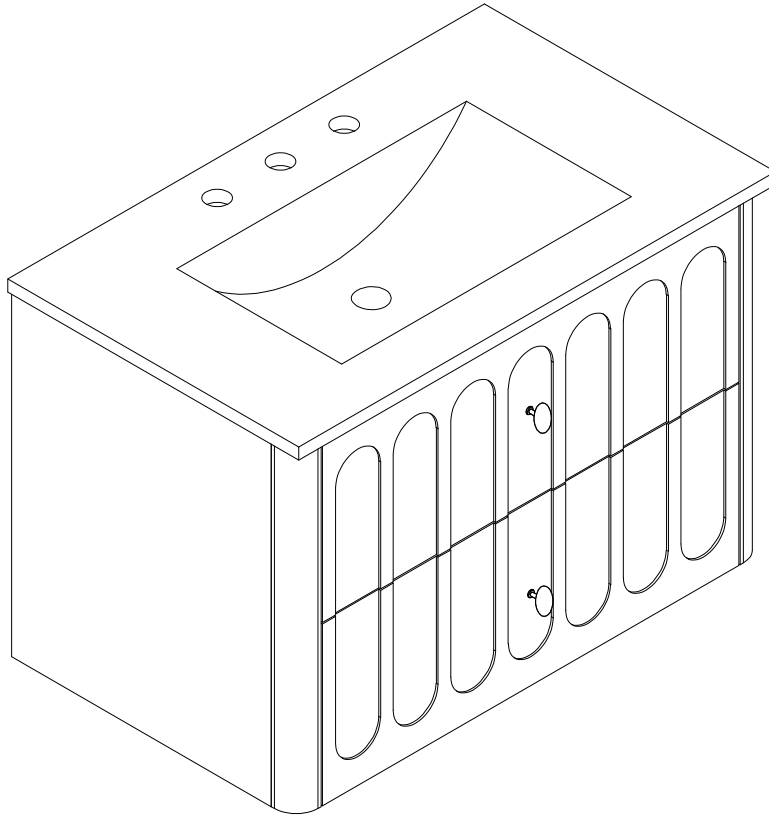

Thank you for purchasing this quality product. Be sure to check all packing material carefully for small parts which may have come loose inside the carton during shipment. Separate, identify and count all parts and hardware.

Compare with the parts list to be sure all parts are present.

"DO NOT TIGHTEN SCREWS UNTIL COMPLETELY ASSEMBLED"

▲
* Use of power tool to assemble this product will invalidate any claim and damage this product making unsafe !!!
* Please assemble on a clean soft surface to avoid damage.



Tools Required

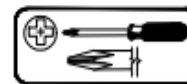

(Not included)

IMPORTANT:

PLEASE READ INSTRUCTION BEFORE STARTING THE ASSEMBLY

Before Installation



Important - Please read these instructions fully before starting assembly

Thank you for purchasing this quality product. Be sure to check all packing materials carefully for small parts, which may have come loose inside the carton during shipment. Identify and count all items according to the PARTS LIST and/or HARDWARE LIST shown below. Check you have all the components and tools listed on the following pages.

- . We recommend that you assemble this product with the assistance of another person; this will make the assembly easier, and will help eliminate damage to the product or injury to persons during assembly.
- . Please do not over tighten screws or bolts until the assembly is completed.
- . Keep children and animal away from the work area, small parts could choke if swallowed.
- . Please put all parts on a non-abrasive floor before assembly, and follow the assembly steps to assemble your newly purchased product correctly and efficiently.

If you find that you have any trouble with assembly or missing or damaged parts please contact the seller.

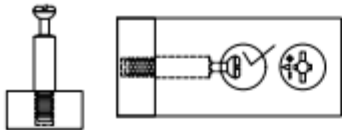
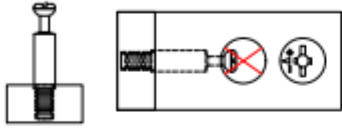
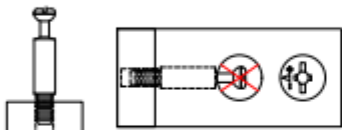
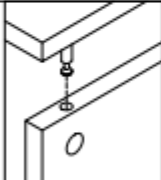
Cam Lock Assembly Instructions

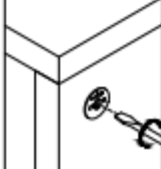
	Insert Cam Bolt into hole as shown in diagram A.
	Make sure not to insert the Cam Bolt. Too deep as shown in figure B as this will cause the Cam Lock to be misaligned and unable to interlock properly.
	Also avoid inserting the Cam Bolt too close to the surface of the hole as shown in figure C, as this will cause the Cam Lock to be too loose, and not interlock properly.
	Connect the panels together.
 ARROW SIGN	Insert the Cam Lock so the side opening fits over the head of the Cam Bolt.
	To tighten the Cam Lock, turn it clockwise on half a turn with a flat screwdriver. <i>*Do not use an automatic screwdriver as it may bend or break if too much power is imposed.</i>

Before Installation

Important - Veuillez lire entièrement ces instructions avant de commencer l'assemblage.

Merci d'avoir acheté ce produit de qualité. Assurez-vous de vérifier soigneusement tous les matériaux d'emballage pour détecter les petites pièces qui pourraient s'être détachées à l'intérieur du carton pendant le transport. Identifiez et comptez tous les éléments conformément à la LISTE DES PIÈCES et/ou à la LISTE DU MATÉRIEL indiquée ci-dessous. Vérifiez que vous disposez de tous les composants et outils répertoriés dans les pages suivantes.

- Nous vous recommandons d'assembler ce produit avec l'aide d'une autre personne ; cela facilitera l'assemblage et aidera à éliminer les dommages au produit ou les blessures corporelles pendant l'assemblage.

- Veuillez ne pas trop serrer les vis ou les boulons jusqu'à ce que l'assemblage soit terminé.

- Tenir les enfants et les animaux éloignés de la zone de travail, les petites pièces pourraient s'étouffer en cas d'ingestion.

- Veuillez placer toutes les pièces sur un sol non abrasif avant l'assemblage et suivre les étapes d'assemblage pour assembler correctement et efficacement votre produit nouvellement acheté.

Si vous constatez des problèmes d'assemblage ou des pièces manquantes ou endommagées, veuillez contacter le vendeur.

Instructions d'assemblage du verrou à came

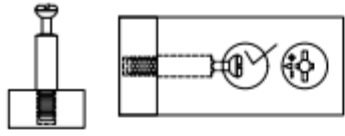
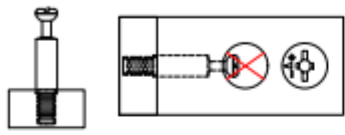
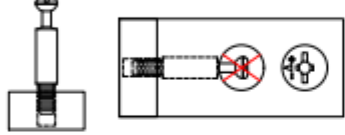
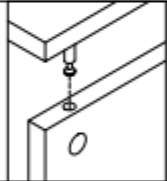
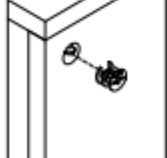
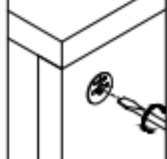
	Insérez le boulon à came dans le trou comme indiqué sur le schéma A.
	Veillez à ne pas insérer le boulon à came trop profondément, comme illustré à la figure B, car cela entraînerait un désalignement du verrou à came et son incapacité à se verrouiller correctement.
	Évitez également d'insérer le boulon à came trop près de la surface du trou, comme illustré à la figure C, car cela entraînerait un desserrage excessif du verrou à came et un mauvais verrouillage.
	Connectez les panneaux ensemble.
	ARROW SIGN Insérez le verrou à came de manière à ce que l'ouverture latérale s'adapte à la tête du boulon à came.
	Pour serrer le Cam Lock, tournez-le d'un demi-tour dans le sens des aiguilles d'une montre à l'aide d'un tournevis plat. <i>*N'utilisez pas de tournevis automatique, car il risque de se tordre ou de se casser si vous appliquez une force excessive.</i>

Detail View - VANITY
(Vue détaillée - Vanité)

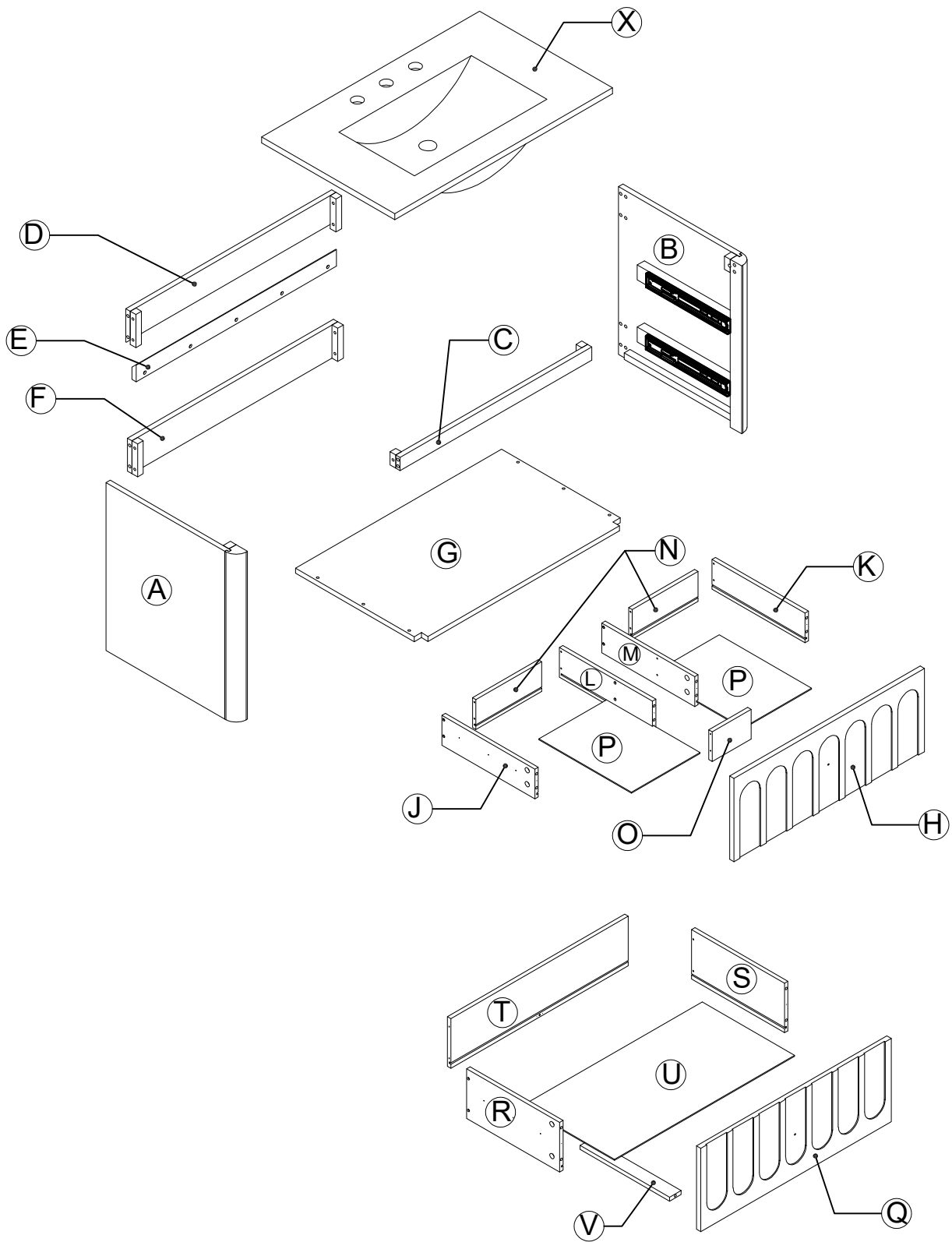

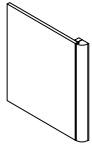
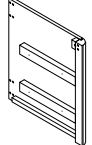
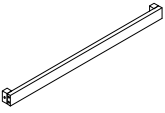
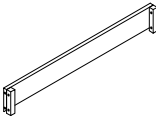
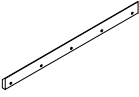
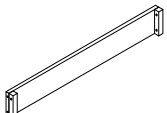
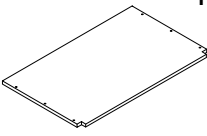
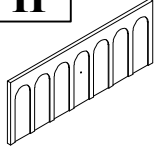
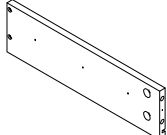
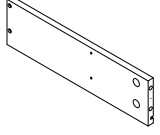
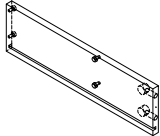
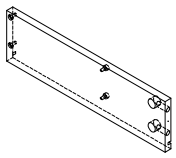
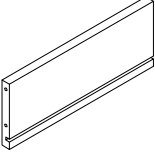
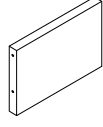
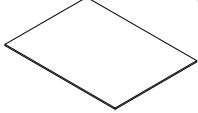
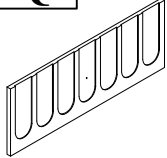

Part List (Liste des pièces)

<p>A</p> <p>Side Panel (L) Panneau latéral</p>  <p>1 PC</p>	<p>B</p> <p>Side Panel (R) Panneau latéral</p>  <p>1 PC</p>
<p>C</p> <p>Front Rail Rail avant</p>  <p>1 PC</p>	<p>D</p> <p>Back Panel Panneau arrière</p>  <p>1 PC</p>
<p>E</p> <p>Wood cleat</p>  <p>1 PC</p>	<p>F</p> <p>Back Panel Panneau arrière</p>  <p>1 PC</p>
<p>G</p> <p>Bottom Panel Panneau inférieur</p>  <p>1 PC</p>	<p>H</p> <p>Front Drawer Cadre avant du tiroir</p>  <p>1 PC</p>
<p>J</p> <p>Side Drawer Panel (L) Panneau latéral du tiroir</p>  <p>1 PC</p>	<p>K</p> <p>Side Drawer Panel (R) Panneau latéral du tiroir</p>  <p>1 PC</p>
<p>L</p> <p>Side Drawer Panel (L) Panneau latéral du tiroir</p>  <p>1 PC</p>	<p>M</p> <p>Side Drawer Panel (R) Panneau latéral du tiroir</p>  <p>1 PC</p>
<p>N</p> <p>Back Panel Panneau arrière</p>  <p>2 PCS</p>	<p>O</p> <p>Back Panel Panneau arrière</p>  <p>1 PC</p>
<p>P</p> <p>Bottom Drawer Panel Panneau de tiroir inférieur</p>  <p>2 PCS</p>	<p>Q</p> <p>Front Drawer Cadre avant du tiroir</p>  <p>1 PC</p>

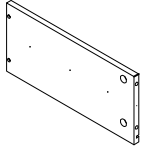
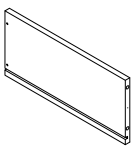
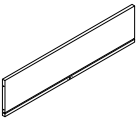
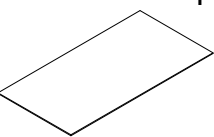
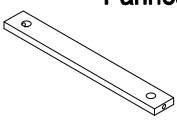
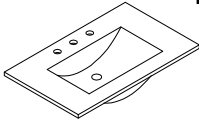

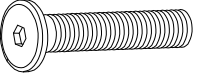
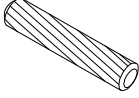
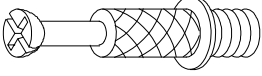
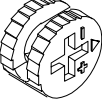
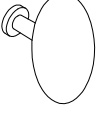
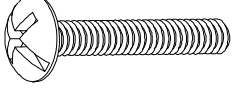
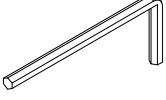
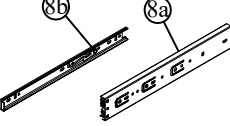
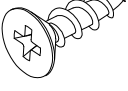

Part List (Liste des pièces)

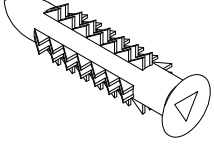
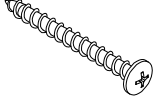
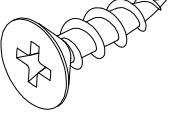
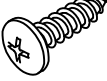
<p>R Side Drawer Panel (L) Panneau latéral du tiroir</p>  <p>1 PC</p>	<p>S Side Panel (R) Panneau latéral</p>  <p>1 PC</p>
<p>T Back Panel Panneau arrière</p>  <p>1 PC</p>	<p>U Bottom Panel Panneau inférieur</p>  <p>1 PC</p>
<p>V Support bottom Drawer Panneau de tiroir inférieur</p>  <p>1 PC</p>	<p>X Sink- 1PC Lavabo</p>  <p>1 PC</p>

Part List (Liste des pièces)

<p>1</p>  <p>Allen Bolts 1/4"x30 Boulons Allen</p> <p>16 PCS</p>	<p>2</p>  <p>Wooden Ø8 x 30 Enbois</p> <p>12+2 PCS</p>	<p>3</p>  <p>Cam Lock Screws Vis de verrouillage à came</p> <p>14 PCS</p>
<p>4</p>  <p>Cam Lock Serrure à came</p> <p>14 PCS</p>	<p>5</p>  <p>Handle Poignée</p> <p>2 PCS</p>	<p>6</p>  <p>Screws M4x17 boulons à tête de vis</p> <p>2 PCS</p>
<p>7</p>  <p>Allen key M4 Clé Allen</p> <p>1 PC</p>	<p>8</p>  <p>Ball Bearing Soft Close</p> <p>4 SET</p>	<p>9</p>  <p>Screws M3.5x12 Vis Black</p> <p>24-PCS</p>
<p>10</p>  <p>Brackets</p> <p>2 PCS</p>	<p>11</p>  <p>Plastic Stopper</p> <p>9 PCS</p>	<p>12</p>  <p>Screws M4x40</p> <p>9 PCS</p>
<p>13</p>  <p>Screws M3.5x12</p> <p>4 PCS</p>	<p>14</p>  <p>Screws M4x20 Vis</p> <p>16+2 PCS</p>	

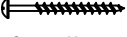

Hardware list: (Anti tipping kit 2 bag in the box)

<p>A</p>  <p>Brackets - 04pcs</p>	<p>B</p>  <p>Steel cables - 02pcs</p>
<p>C</p>  <p>Screws - 02pcs</p>	<p>D</p>  <p>Screws - 02pcs</p>
<p>E</p>  <p>wall anchor - 02pcs</p>	

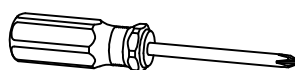
ASSEMBLY TOOLS REQUIRED (NOT INCLUDED)



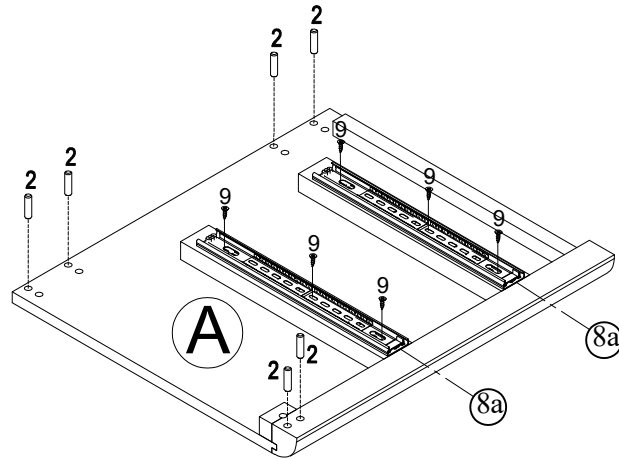

STEP : 1 (ÉTAPE : 1)

2		8a		9	
	Ø8 X 30				M3.5 X12
6 PCS		2 PCS		6 PCS	



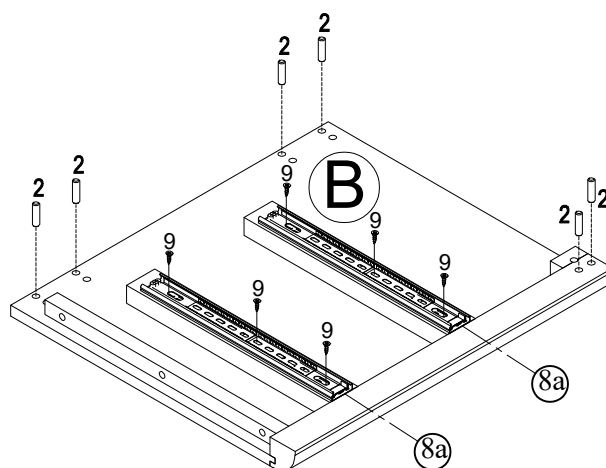

STEP : 2 (ÉTAPE : 2)

2		8a		9	
	Ø8 X 30				M3.5 X12
6 PCS		2 PCS		6 PCS	



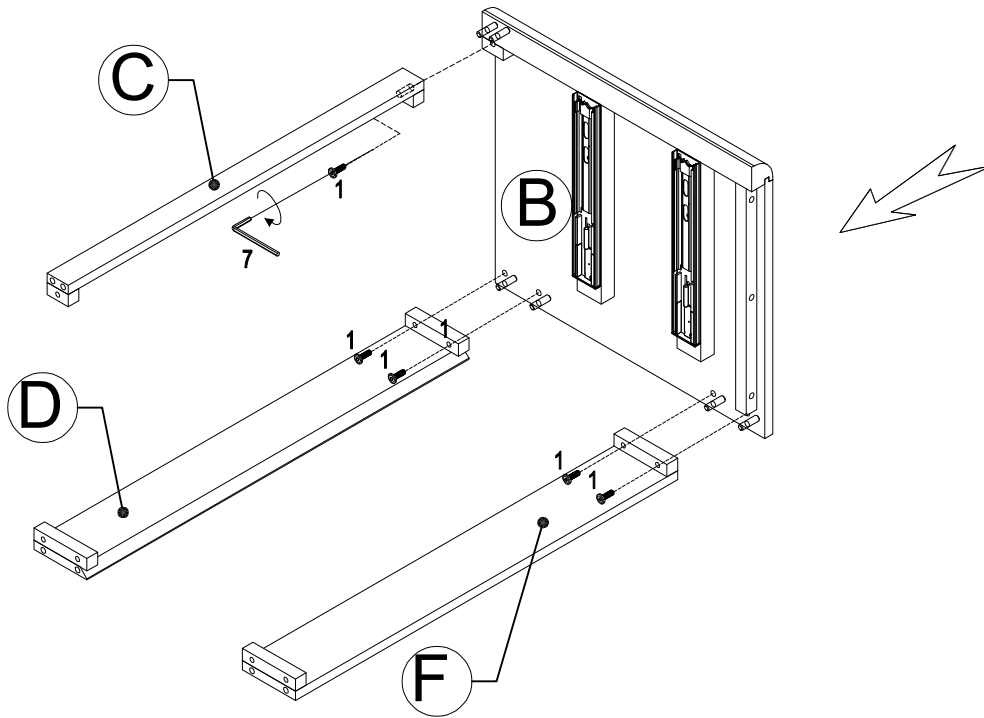

STEP : 3 (ÉTAPE : 3)

7		1	
			1/4X30
1 PC		5 PCS	



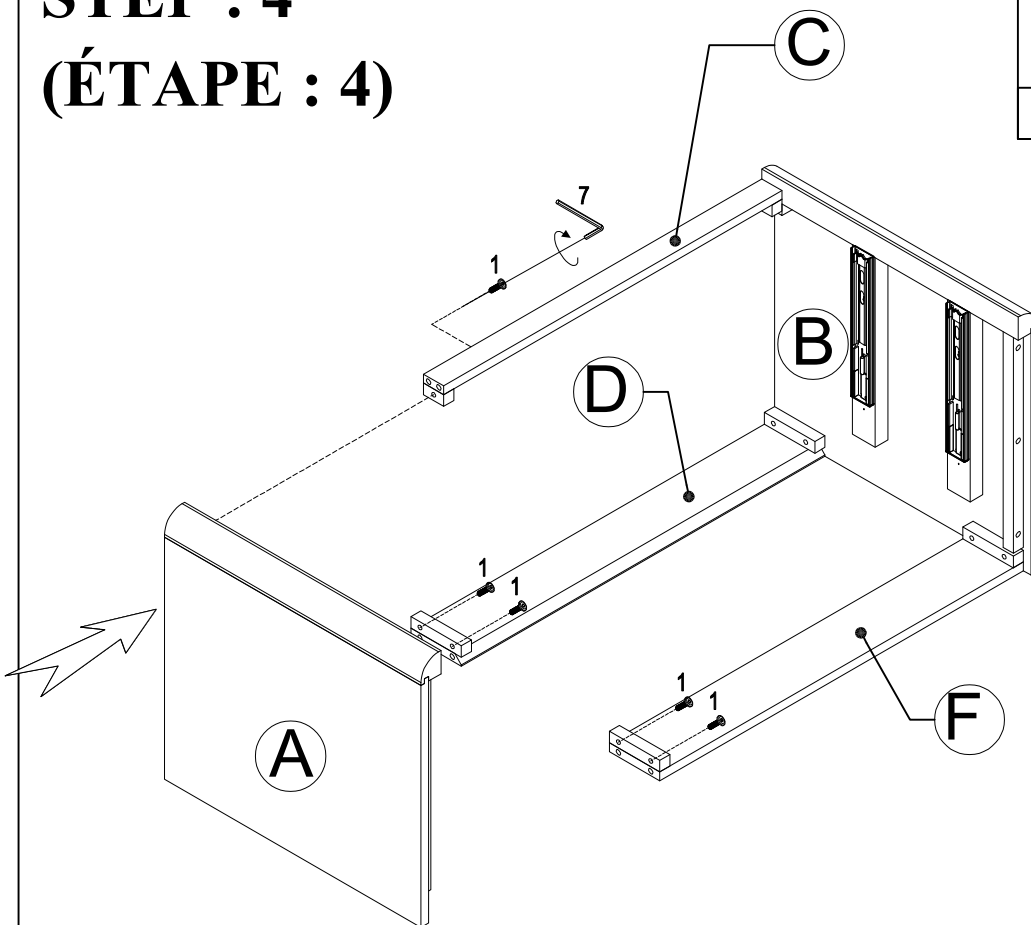

STEP : 4 (ÉTAPE : 4)

7		1	
			1/4X30
1 PC		5 PCS	



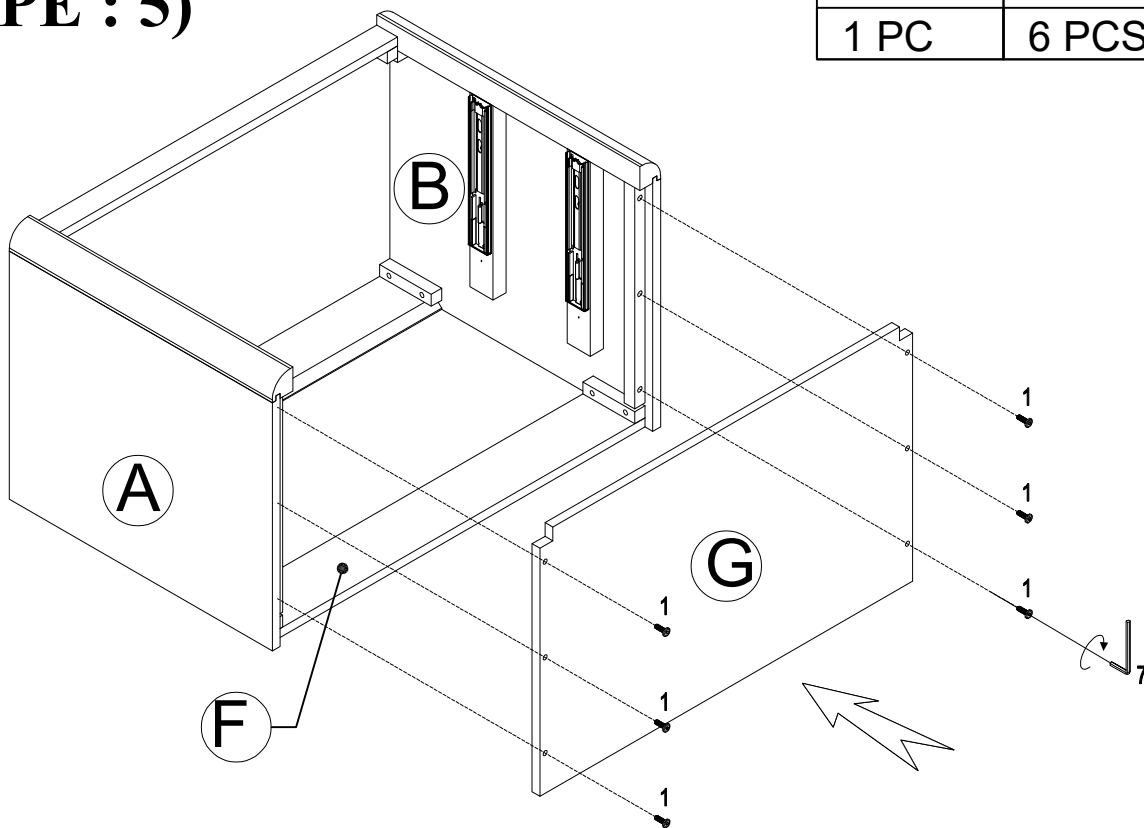

STEP : 5 (ÉTAPE : 5)

7		1	
			1/4X30
1 PC		6 PCS	

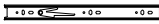

STEP : 6 (ÉTAPE : 6)

8b		9	
			M3.5 X12
2 PCS		6 PCS	

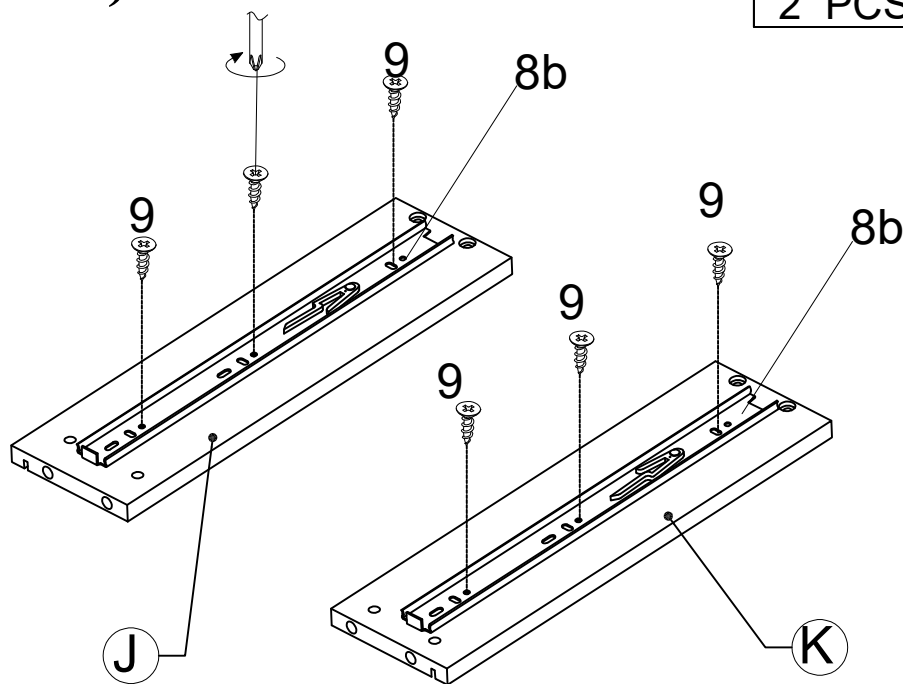

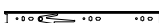
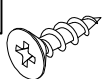

STEP : 7 (ÉTAPE : 7)

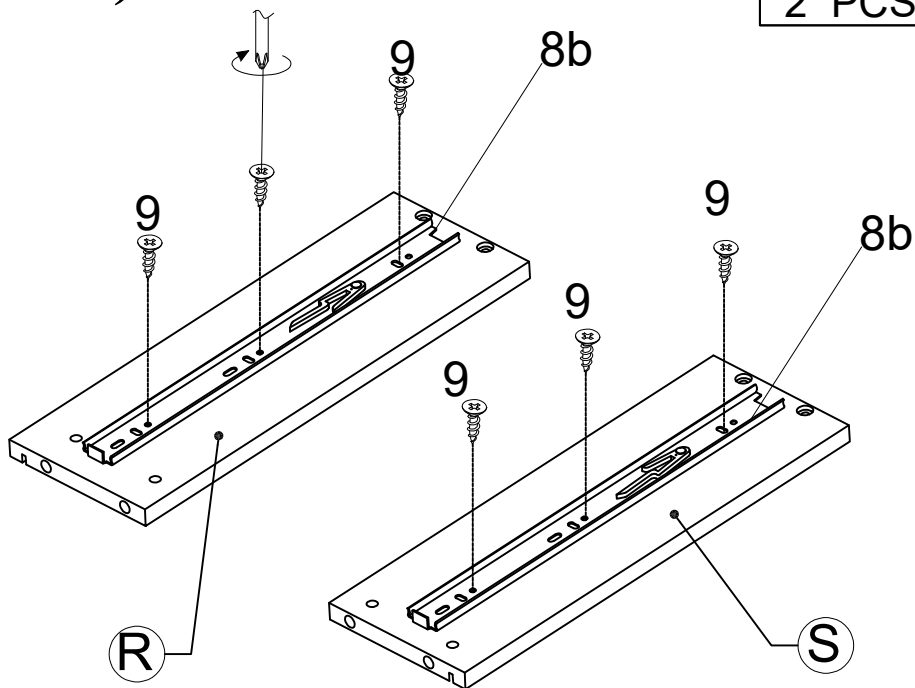
8b	9
	
	M3.5 X12
2 PCS	6 PCS



STEP : 8 (ÉTAPE : 8)

3	5	6
		
14 PCS	2 PCS	M4 X17
2 PCS	2 PCS	

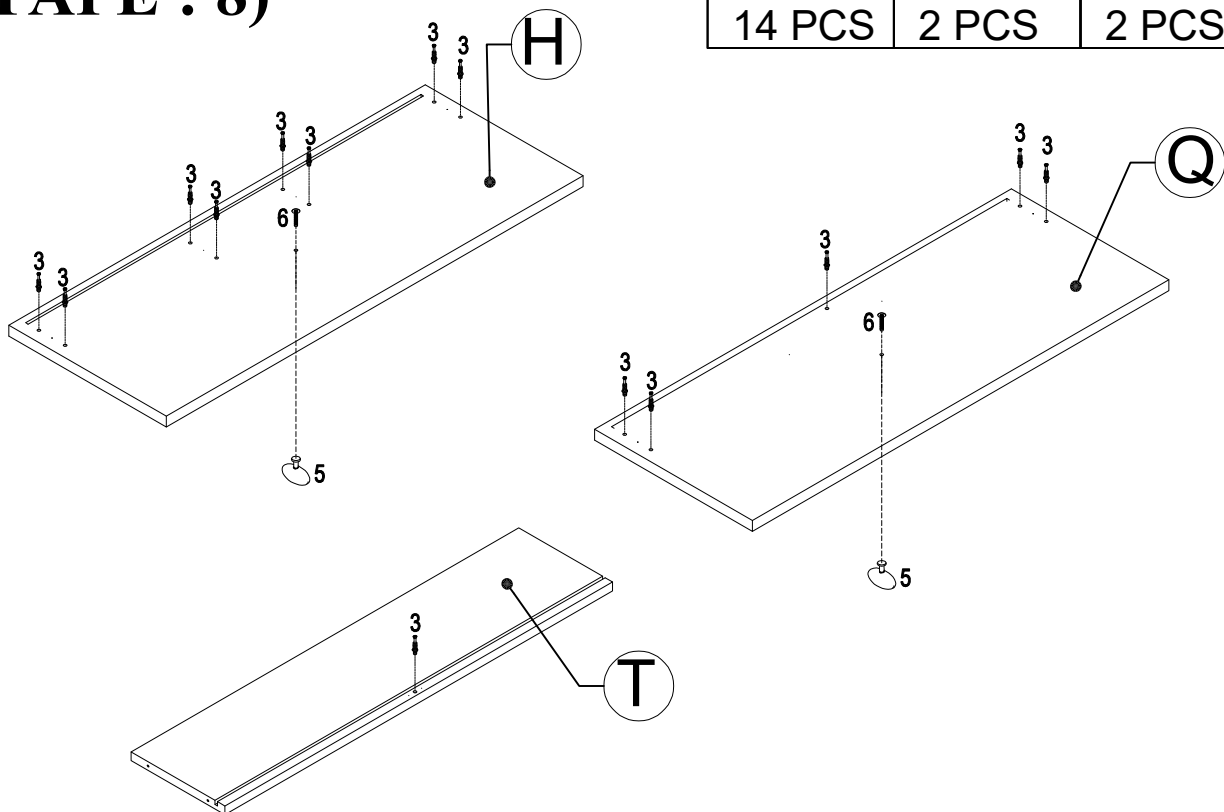

STEP : 9 (ÉTAPE : 9)

14 
M4 X20
8 PCS

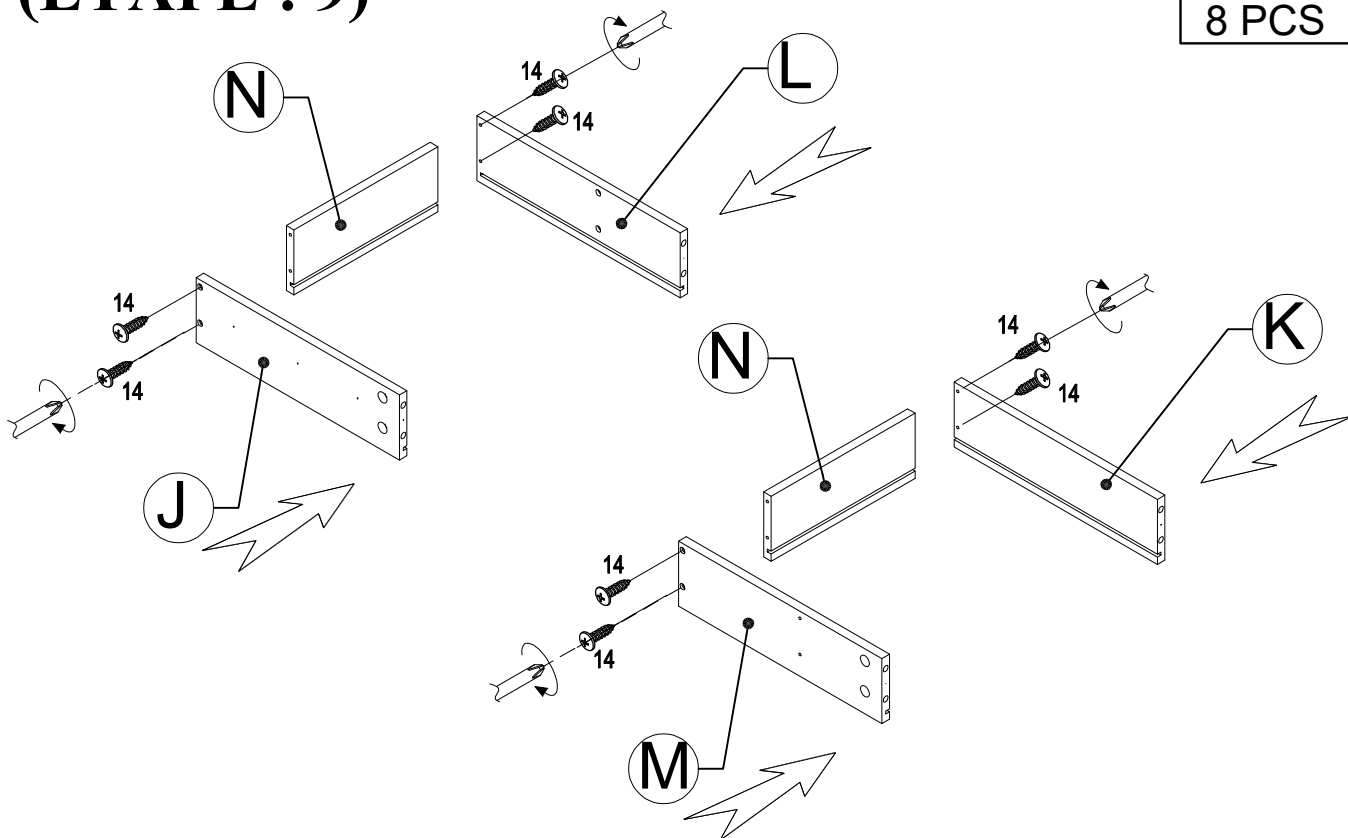

STEP : 10 (ÉTAPE : 10)

14 
M4 X20
4 PCS

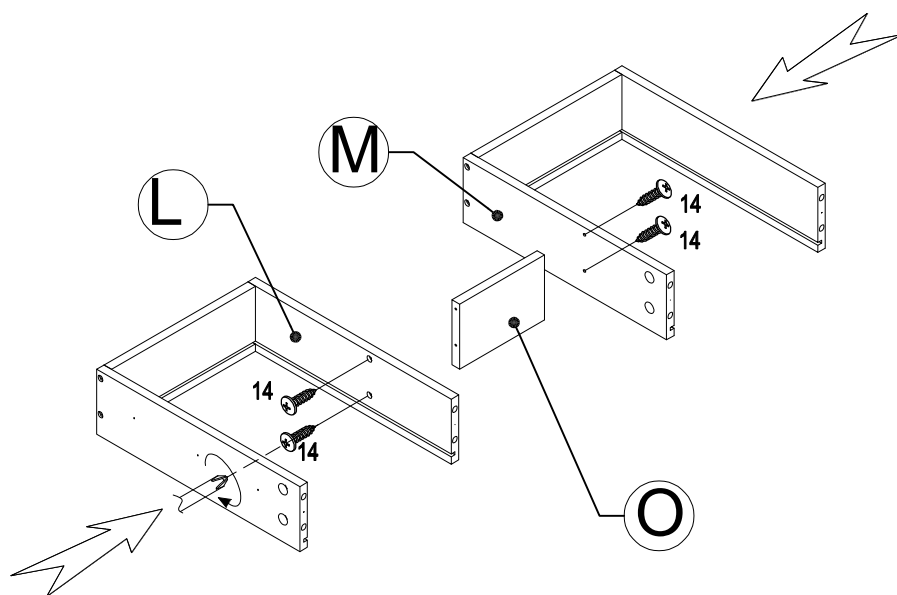

STEP : 11 (ÉTAPE : 11)

4



8 PCS

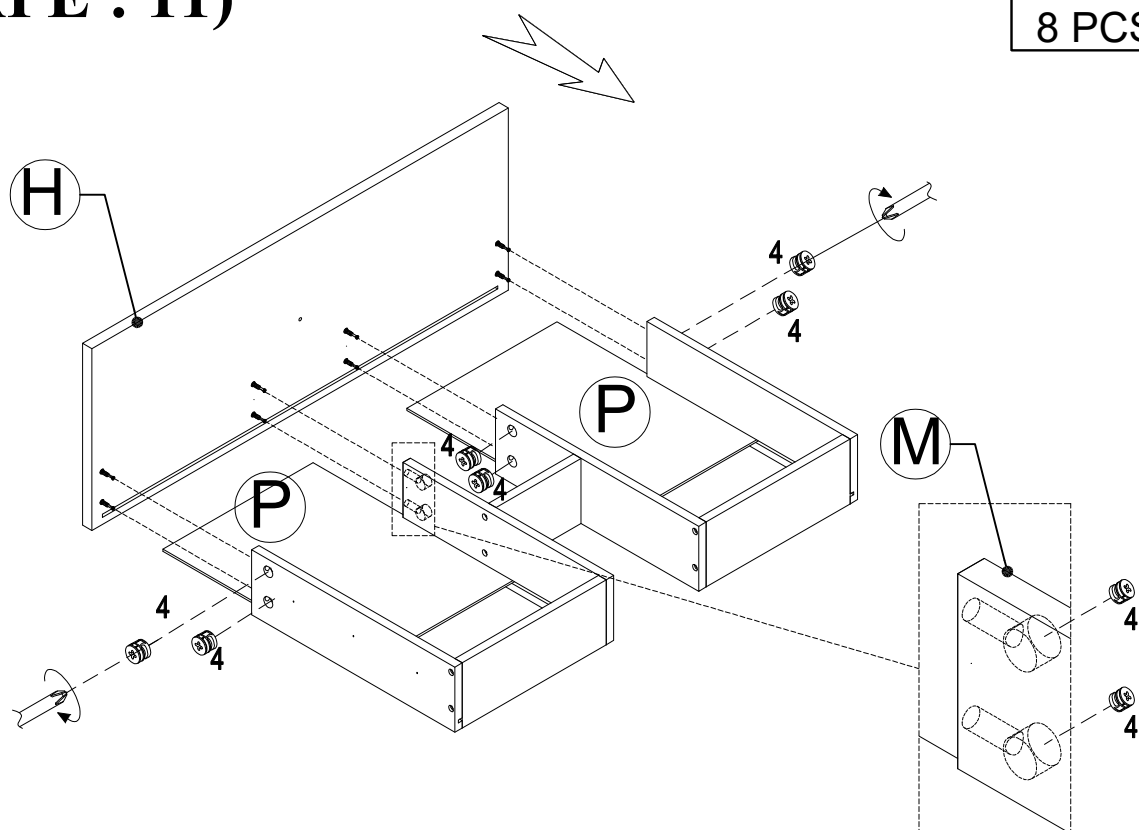

STEP : 12 (ÉTAPE : 12)

14



M4 X20

4 PCS

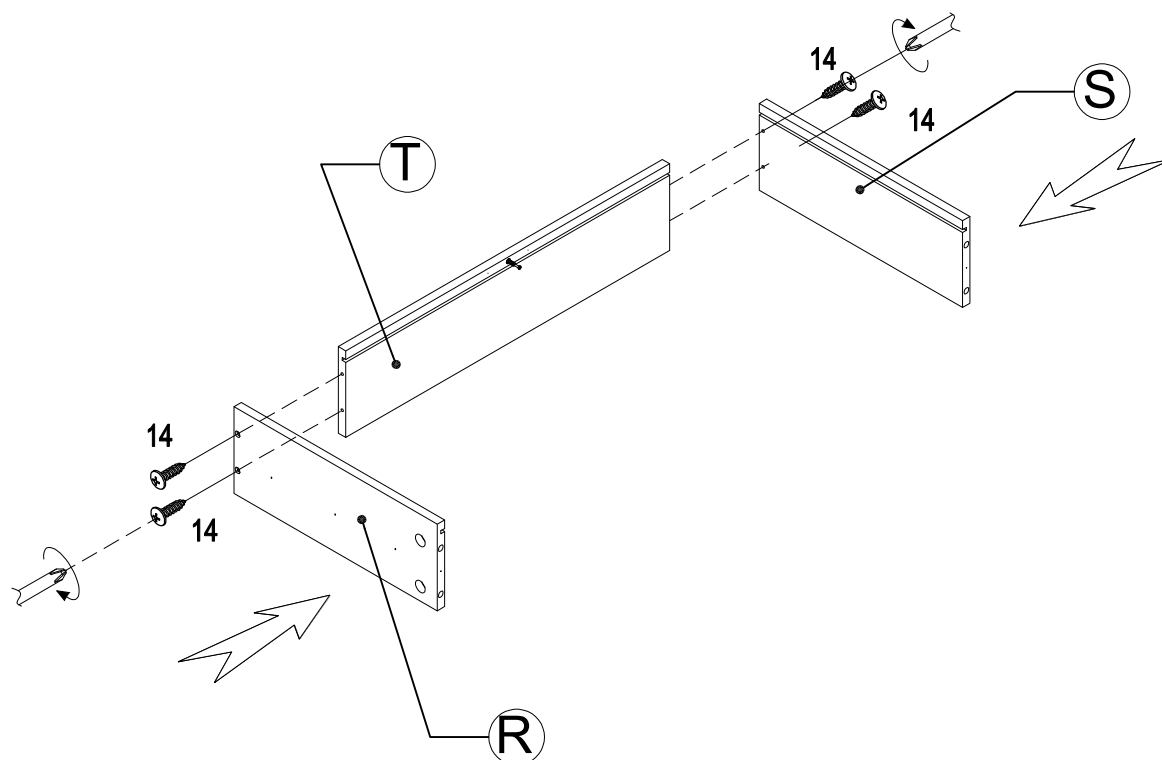

STEP : 13 (ÉTAPE : 13)

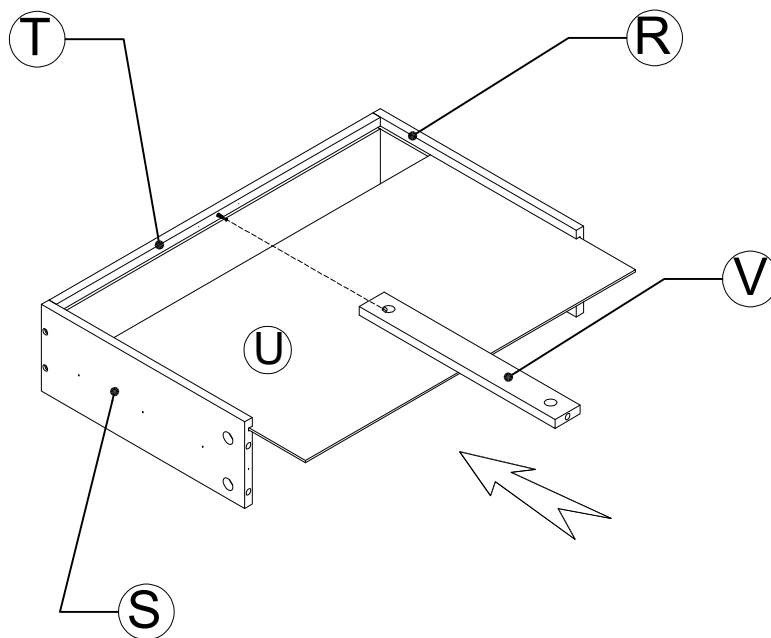

STEP : 14 (ÉTAPE : 14)



4

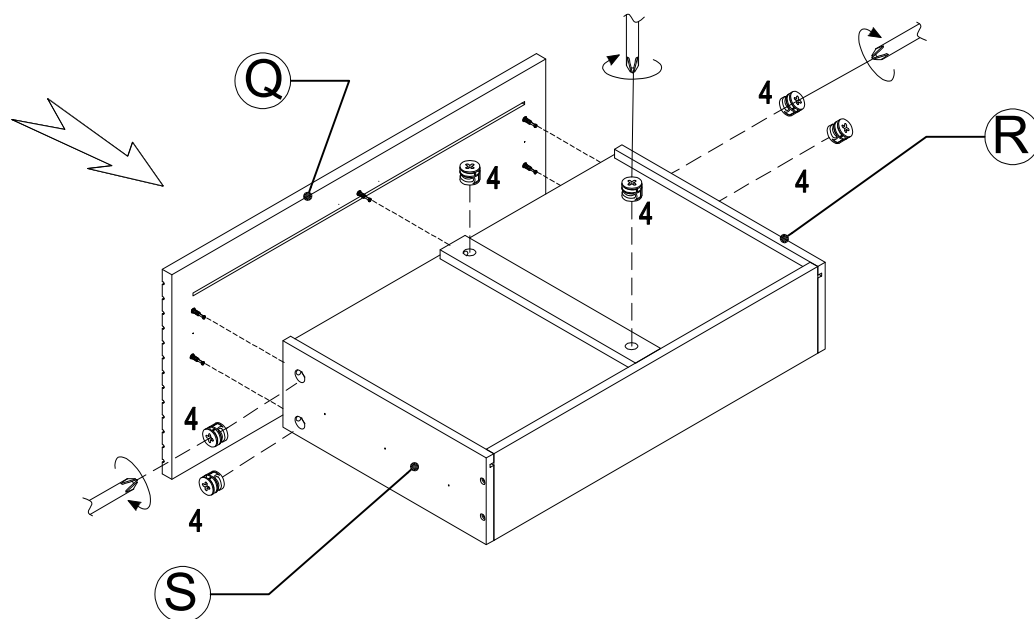

6 PCS

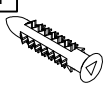

STEP : 15 (ÉTAPE : 15)

11	12
	
5 PCS	M4 X 40 5 PCS

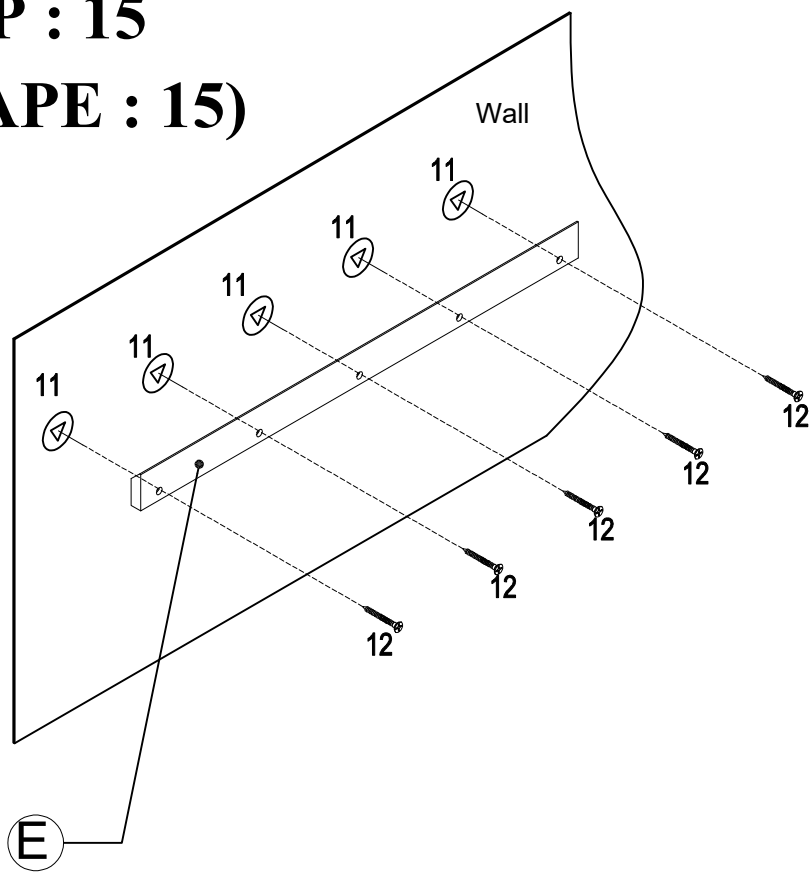

WALL

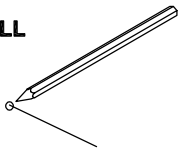

WALL
drilling hole
8x40mm

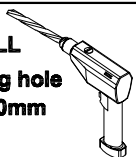

WALL

11

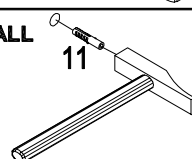



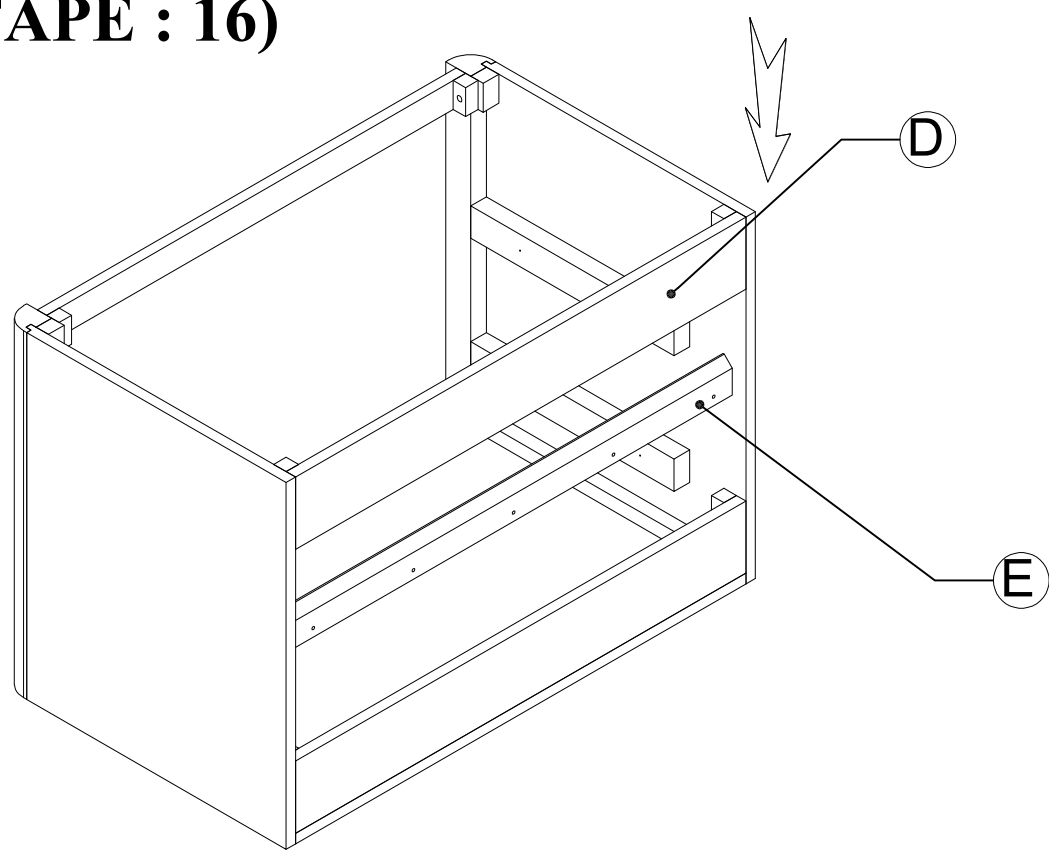

STEP : 16 (ÉTAPE : 16)

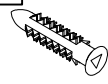

STEP : 17

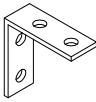
(ÉTAPE : 17)

11 	12 	10 	13 
4 PCS	M4 X 40 4 PCS	2 PCS	M3.5 X12 4 PCS

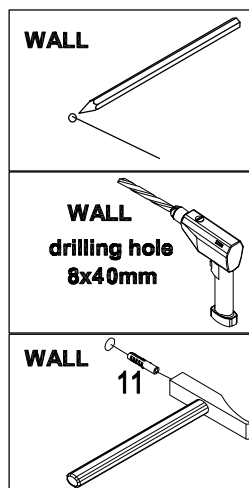
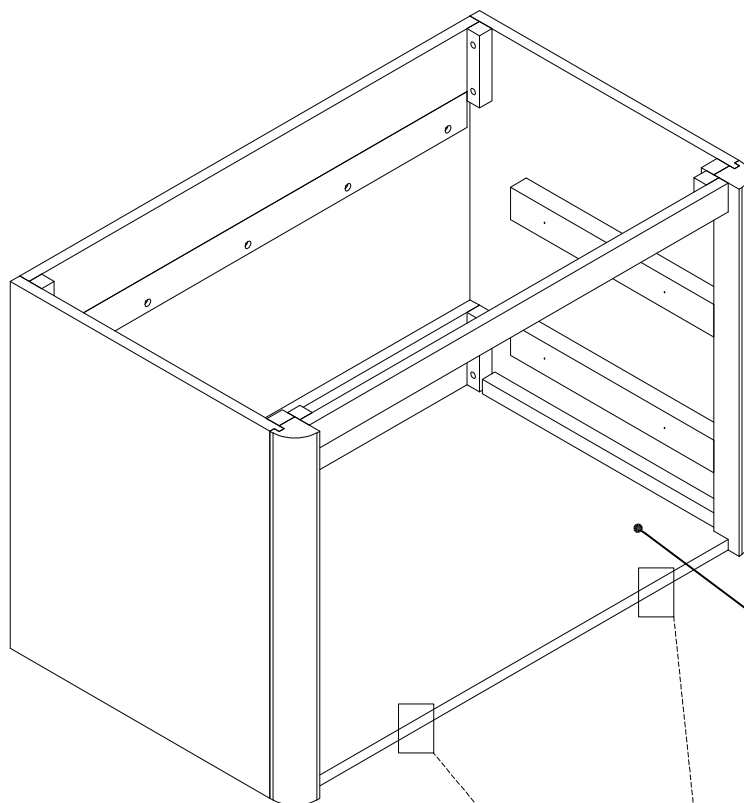

x2

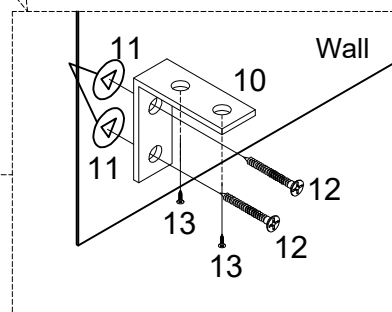

STEP : 18 (ÉTAPE : 18)

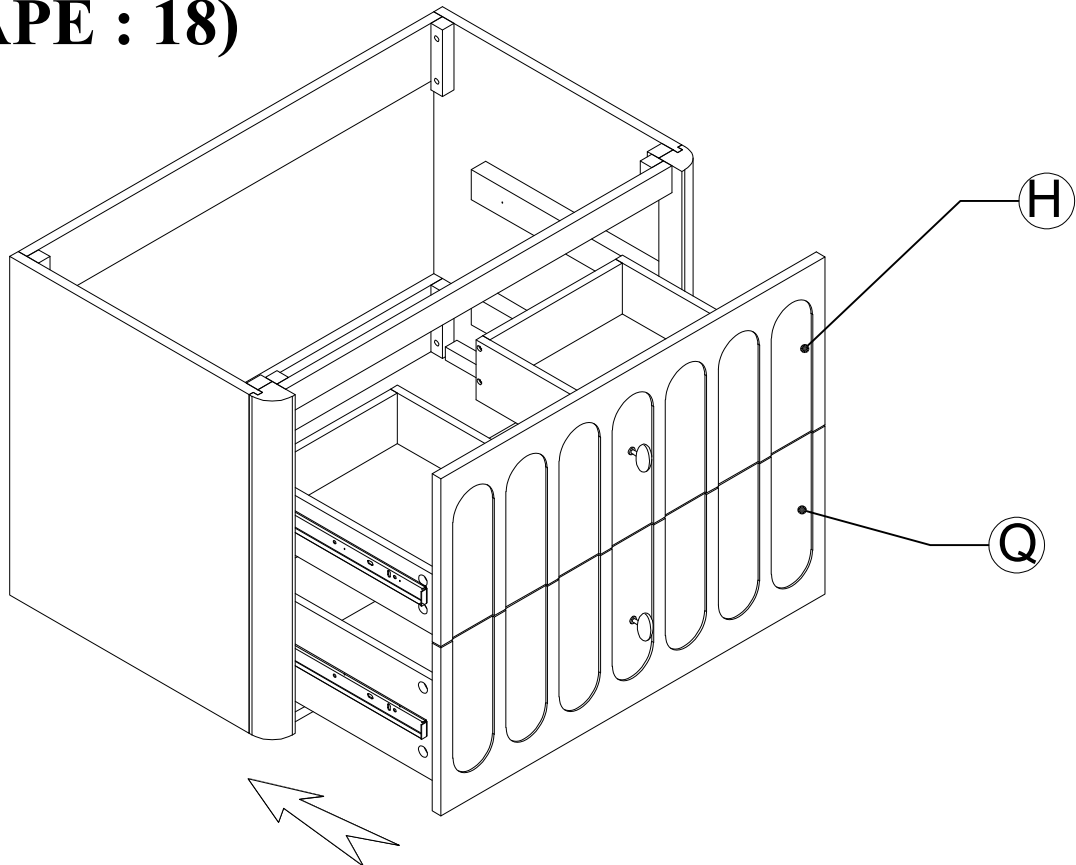

STEP : 19 (ÉTAPE : 19)

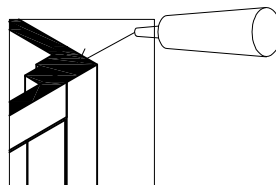
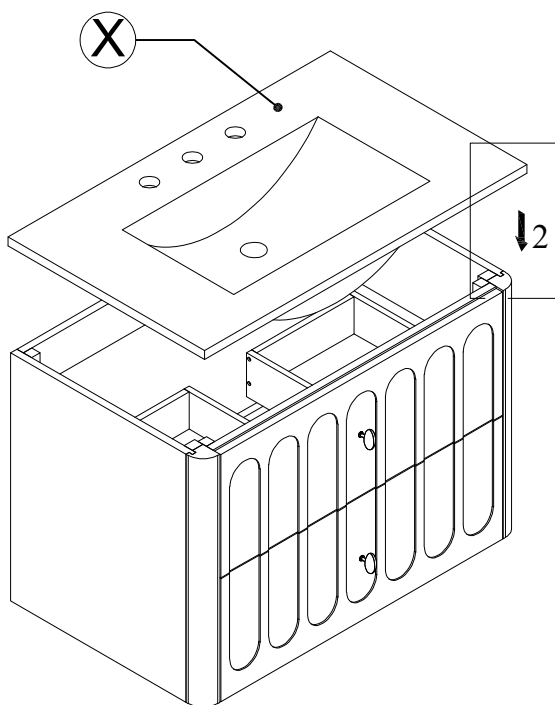

To install the Top (1) to the vanity (2).
Apply silicone caulk to the top edge of the wood cabinet. With the help of another adult, gently lower the Sink top with assembled sink onto the cabinet. Make sure the Sink top is flush with the back side of the wood cabinet and the wood cabinet left and right side walls. Pour installer le dessus (1) sur la vanité (2). Appliquez du mastic silicone sur le bord supérieur

armoie en bois. Avec l'aide d'un autre adulte, abaissez doucement l'évier plan de travail avec évier assemblé sur le meuble. Assurez-vous que le dessus de l'évier est affleurant l'arrière de l'armoie en bois et le armoie en bois parois latérales gauche et droite.