

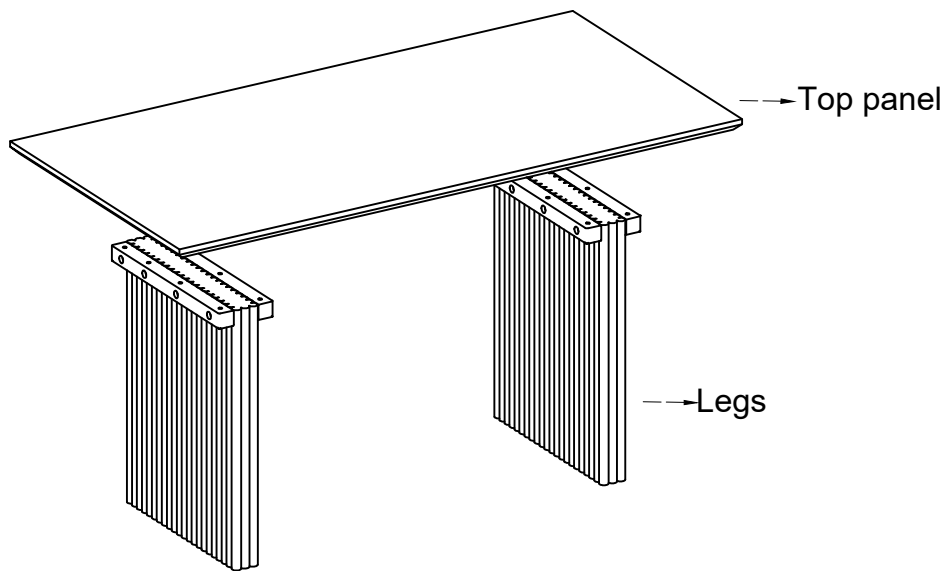

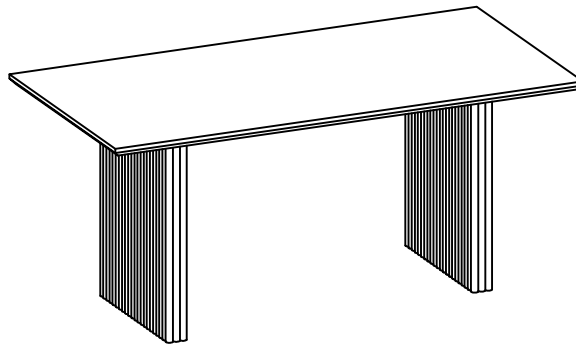

# ASSEMBLY INSTRUCTIONS

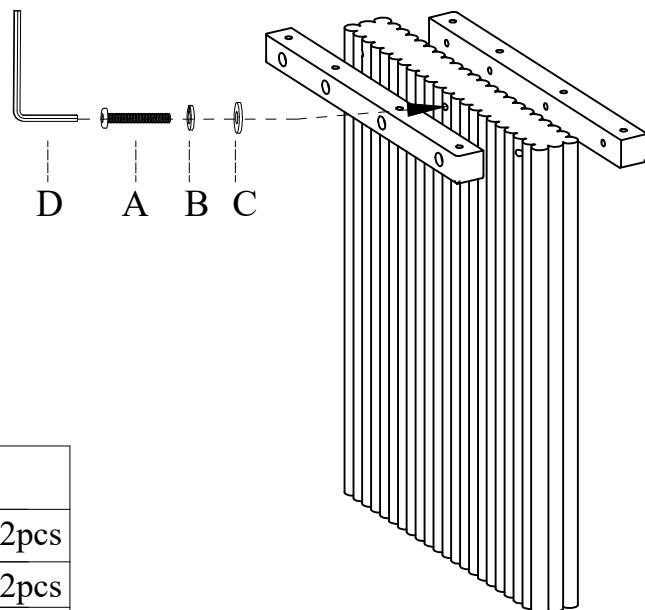

## Step 1



### HARDWARE LIST

A		Bolt (Ø5/16"*2-1/4")	32pcs
B		Lock Washer (Ø5/16")	32pcs
C		Flat Washer (Ø5/16"*Ø3/4")	32pcs
D		Allen Wrench (5mm)	1pc

Step 2

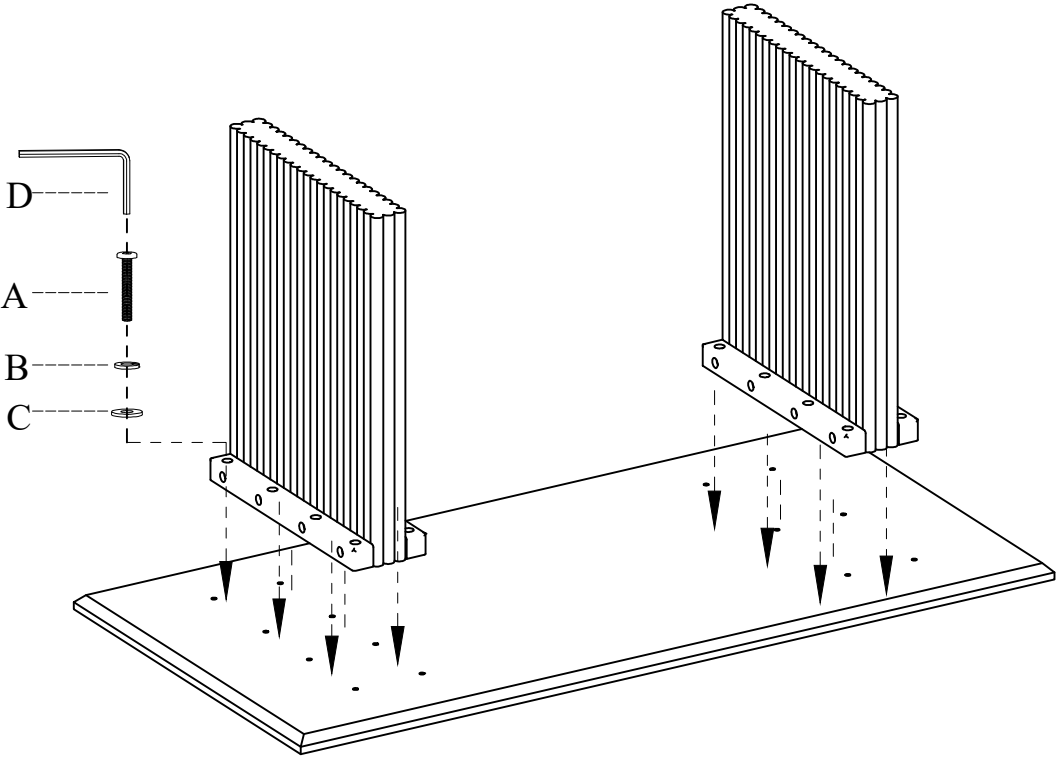

Step 3

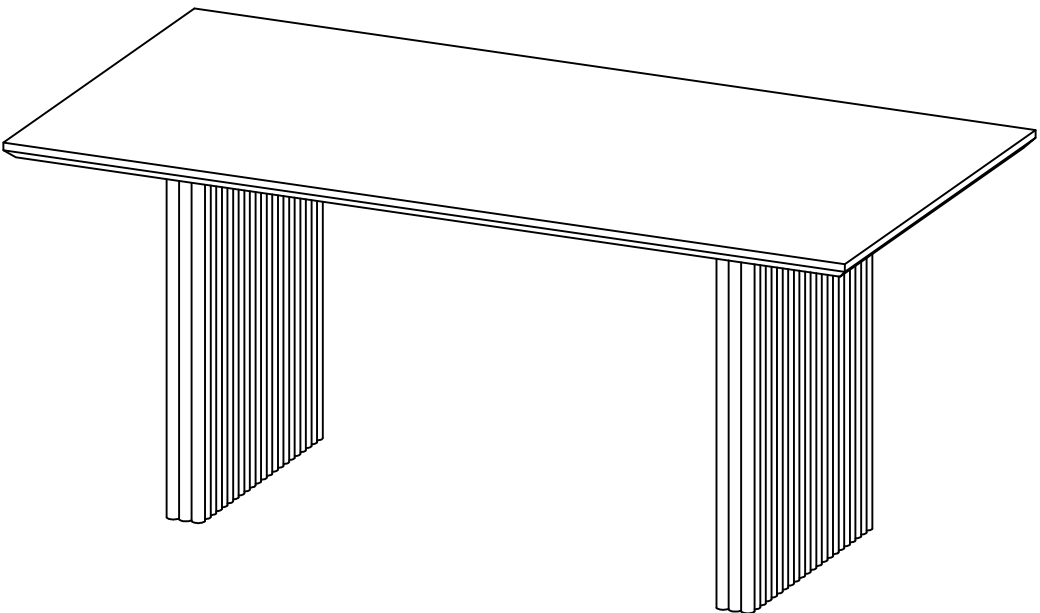

OK