

NOTE:

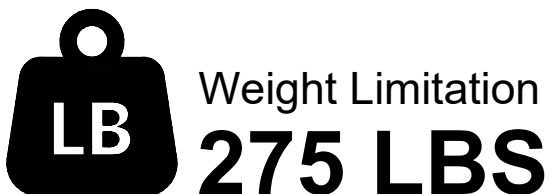

This brochure contains **IMPORTANT** safety info. Please read and keep for future reference.

MAINTAINANCE AND WARNING



- 1.Keep furniture away from heat sources.
- 2.Do not clean furniture with harsh cleaner or polishes.Do not use detergents,solvents,abrasives,spray packs or leather cleaner. Use non-color mild soa with warm water to clean spills(Mix 1:10 soap to water).
- 3.Do not place furniture under direct sunlight,material will possibly fade over time.
- 4.Do not use on site dry cleaning machine.Children should not climb or jump on the furniture.
- 5.Do not write on furniture that is not protectedby a padded barrier.
- 6.Not for commercial use,only for residential use.

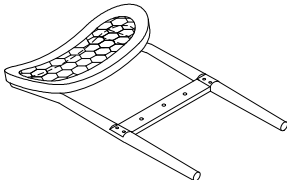
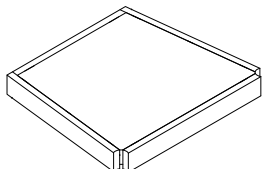

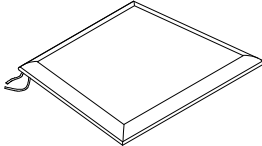
PARTS LIST

A	x1	B	x1	C	x2	D	x1
							

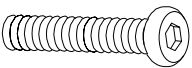
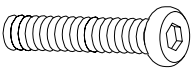
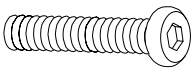

HARDWARE LIST

#1	x10	#2	x10	#3	x2	#4	x4	#5	x4
									
Ø1/4x20mm		Ø1/4x13mm		Ø1/4x1-1/2"		Ø1/4x2-1/2"		Ø1/4x3-3/4"	

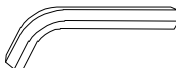
TOOL LIST

#6	x1
	
M4	

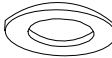
HARDWARE SPARE LIST

#1	x1	#2	x1
			
Ø1/4x20mm		Ø1/4x13mm	

ASSEMBLY INSTRUCTIONS

STEP- 1

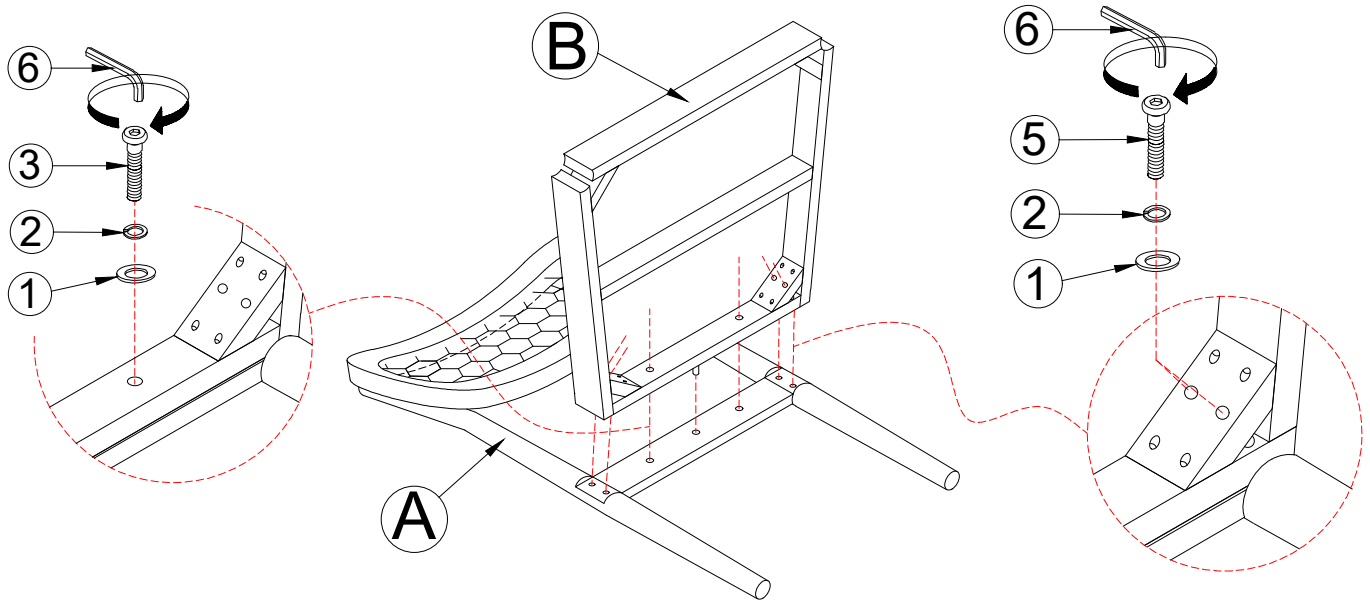

Turn the chair back (A) upside down on to a clean, soft surface. Attach seat frame (B) on the chair back (A) by using Flat washer (1), Lock Washer (2), Bolt (3) and Bolt (5) with Allen Key (6) . (Don't tighten bolt until at step 2).



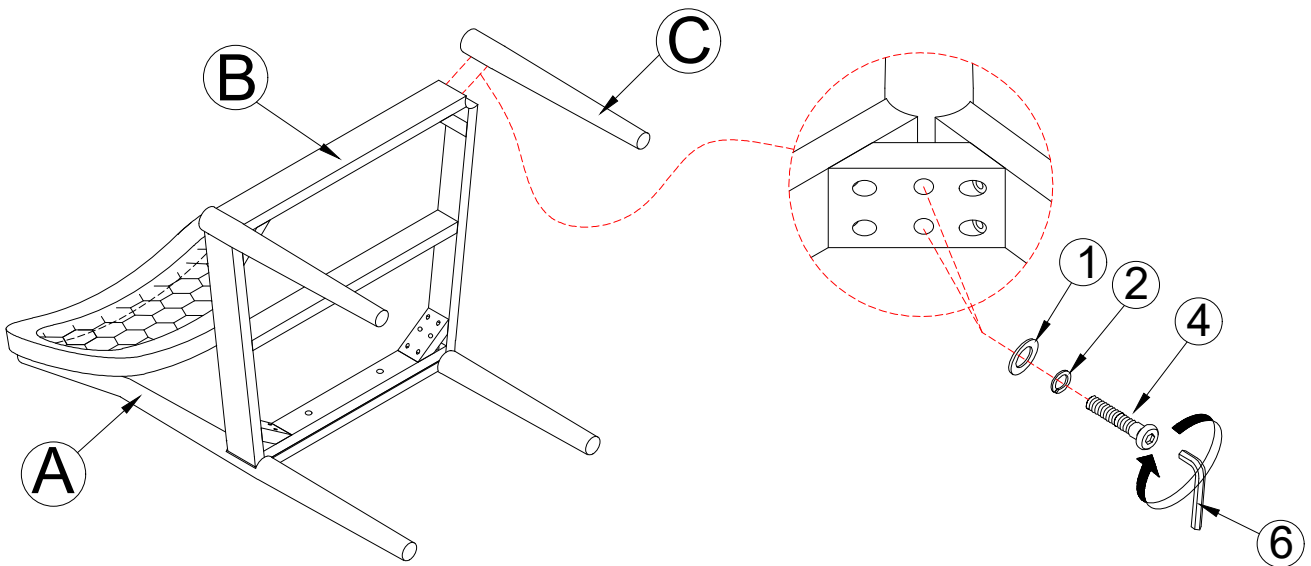

STEP- 2

Attach legs (C) on the chair of step 1 by using Flat washer (1), Lock Washer (2), Bolt (4) with Allen Key (6) .

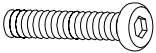

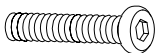
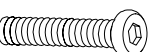
1		x10
2		x10
3		x2

4		x4
5		x4
6		x1

 After installation, please keep the chair balanced, tighten all bolts.

ASSEMBLY INSTRUCTIONS

STEP- 3

Attach seat cushion (D) on the chair .

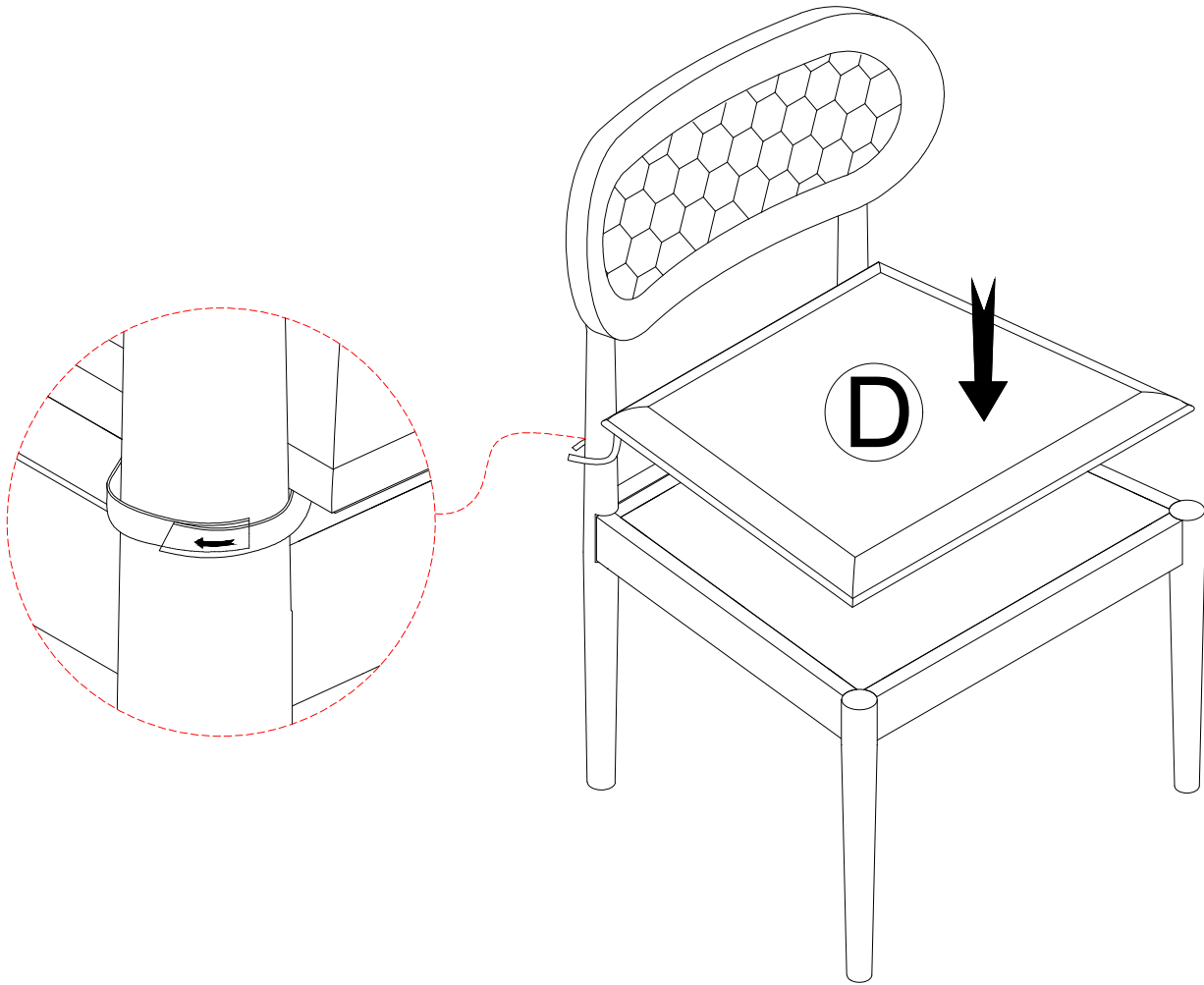

WARRANTY

1. We strive to offer high-quality products, and we also try our best to satisfy each and every customer that orders from us with product or service as needed.
2. We provide 30 days warranty starting from the time you receive the item. Each customer must provide a record of their order such as the order number, or item receipt for any items that are out of the warranty period you may also still receive.
3. Replacement parts by purchasing them with our company if they are available.