

LARGE CROSSWEAVE FIRE BOWL FIRE PIT

Review all assembly and care information before using this product. Save this manual for future reference.
Assemble components on a soft, clean surface to avoid damaging the finish.

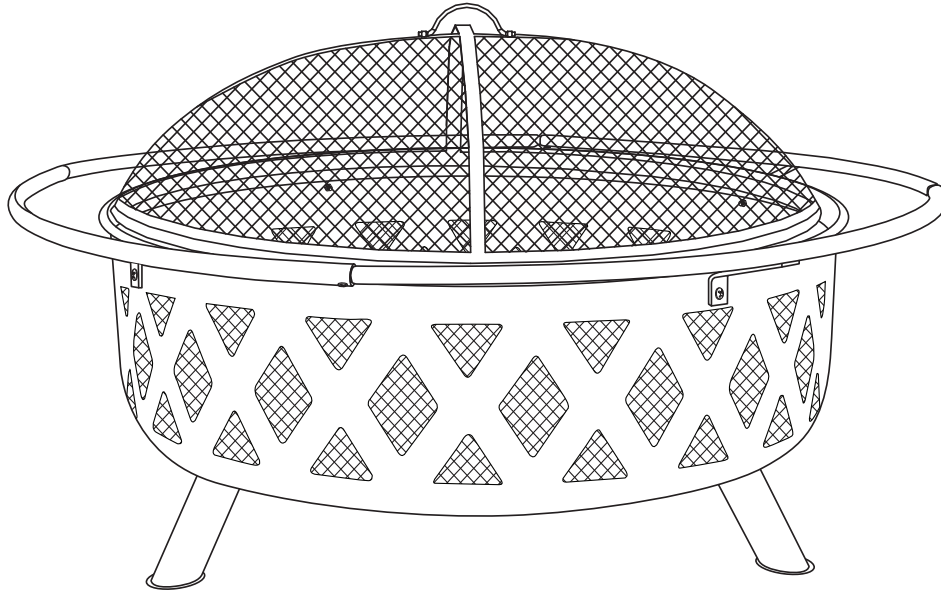

Inspect packaging to ensure all parts are accounted for before disposing of packing materials.







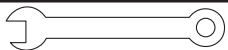

TOOLS REQUIRED (not included)

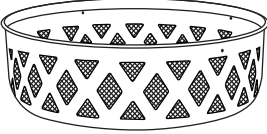

Phillips Screwdriver



10mm Wrench

| No. | PARTS | QTY. |
|-----|--|------|
| A |  Fire Bowl | 1 |
| B |  Leg | 3 |
| C |  Safety Ring | 4 |
| D |  Spark Screen | 1 |
| E |  Poker/Screen Lifter | 1 |
| F |  Cover | 1 |
| 1 |  M6x12mm Bolt | 17 |
| 2 |  M6 Nut | 13 |

⚠ WARNING ⚠

CHOKING HAZARD — This item contains small parts that can be swallowed. Keep children and pets away during assembly.

⚠ WARNING:

Manufacturer and seller expressly disclaim any and all liability from personal injury, property damage or loss, whether direct or indirect, or incidental, resulting from the incorrect attachment, improper use, inadequate maintenance, or neglect of this product.

ASSEMBLY

Review all steps and understand assembly before beginning.
Do not fully tighten hardware until instructed to do so.

STEP 1

A: 1

B: 3

1: 9

2: 9

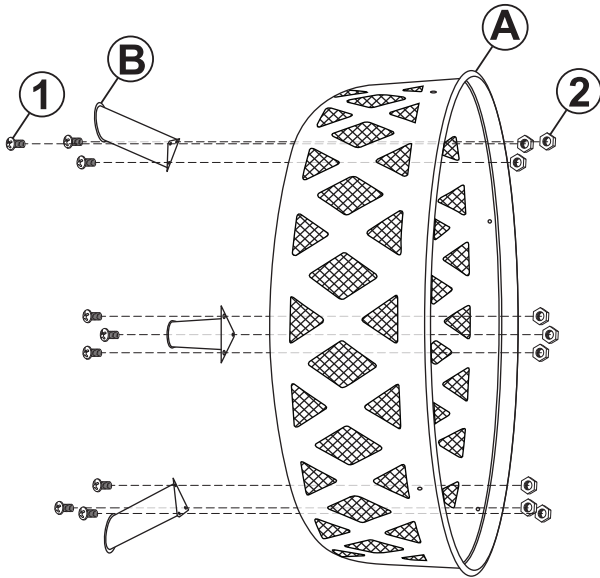

Ensuring the flat edge of the leg is facing outward, align Leg (B) with the bottom of Fire Bowl (A) and loosely fasten using three M6x12mm Bolts (1) and M6 Nuts (2).

Repeat to attach the remaining two legs.

Finish tightening hardware on all legs.

STEP 2

C: 4

1: 4

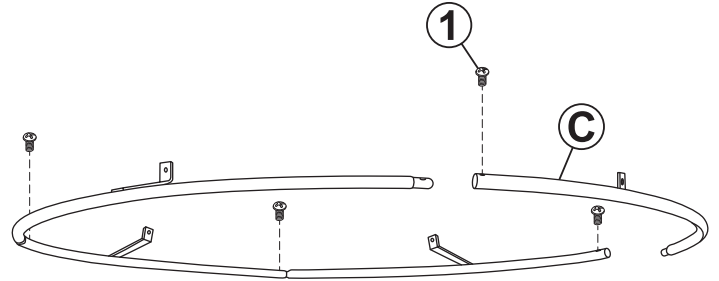

With the brackets facing upward, align four Safety Rings (C) and loosely secure using four M6x12mm Bolts (1).

Do not fully tighten bolts until after Step 3 is complete!

STEP 3

1: 4

2: 4



Assistance is recommended for this step.

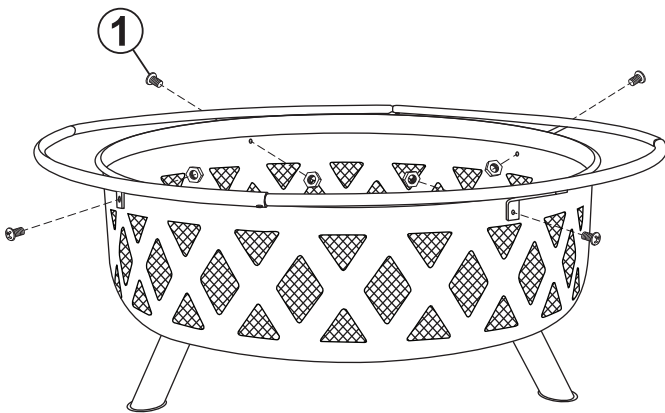

Carefully guide the assembled ring over the fire bowl and align the safety ring brackets with the fire bowl mounting holes. Then, loosely fasten the ring to the bowl using four M6x12mm Bolts (1) and M6 Nuts (2).

Do not fully tighten hardware until after all bolts have been installed.

STEP 4

D: 1

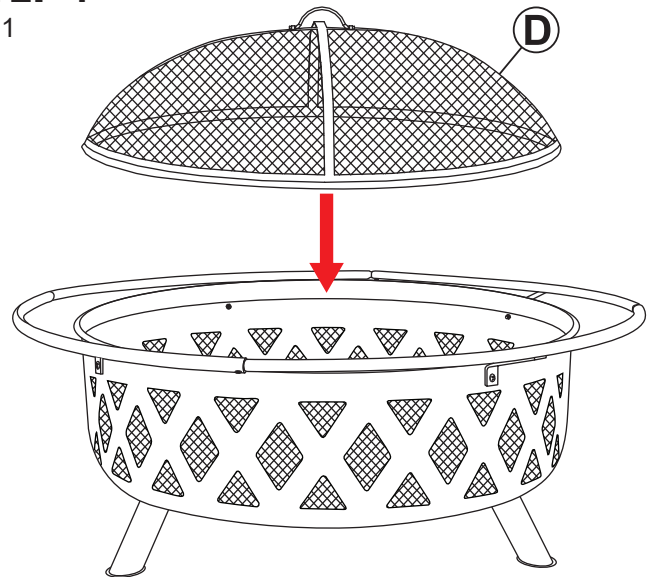

Fully tighten all safety ring hardware.

Place Spark Screen (D) onto the assembled unit.

CARE & MAINTENANCE

SAFE USE: Always use fire pits on a flat, non-combustible surface such as concrete, rock, or stone. Do not use this fire pit on a wood deck or any other combustible surfaces like dry grass, leaves, mulch, etc. Never use in an area with an overhead structure or near any unprotected combustible constructions like vinyl or wood siding. Avoid using near or under overhanging trees and shrubs.

The fire pit and screen will become extremely hot while in use. Always use the poker/lifting tool and heat-resistant gloves when maintaining a fire.

NO ACCELERANTS, NO PLASTICS: Never use an accelerant, i.e. gasoline or kerosene, to start a fire; this is dangerous and can damage your fire pit.

Never use any plastic materials in or nearby a fire pit. The emissions from burning plastic are toxic. Additionally, plastic residue is very difficult to remove.

EXTINGUISH: Let fires gradually die down and go out on its own. DO NOT use water to put out a fire as the sudden drop in temperature may damage the metal and/or cause serious injury.

EXPOSURE & MAINTENANCE: Long-term exposure to high-intensity heat can cause the mesh screen to warp and the high-temperature paint to flake or burn off the steel. If the paint burns off and the steel is exposed to moisture, it will rust. As with any outdoor steel product, periodic maintenance is required to maintain integrity and appearance. Remove rust and refinish with a paint that is suitable for high-temperature surfaces; carefully follow the paint manufacturer instructions and ensure the paint is completely dry before using the unit again. **WARNING:** The one-year warranty does not cover damages or defects caused by painting and/or repairs.

CLEANING: Ensure the fire pit and ashes are completely cool before cleaning. Ashes can remain hot long after a fire dies down. If you feel heat when your hand is close to the metal or the ashes, the fire pit is too hot to clean.

Remove ashes and debris from the fire bowl before every use.

COVER AND STORE: Ensure the fire pit is completely cool before covering. Always clean the fire pit before covering it. Do not allow the fire pit to be exposed to water. The manufacturer is not liable for damage resulting from general use and/or environmental conditions. Store in a dry location; this will protect it from the effects of weather elements.

SAFETY STATEMENTS & WARNINGS

- For outdoor use only. Never use this product in an enclosed area.
- Always follow local laws and regulations when using wood-burning fire pits.
- Exercise the same care and precautions as you would with an open fire.
- Always supervise children and pets when they are in proximity of this product, whether it is in use or not in use.
- Never use any fire pit during dry or windy conditions.
- Keep unit a safe distance away from buildings, balconies, or overhangs when in use.
- Do not use on or near combustible surfaces or structures such as wood decks, dry leaves or grass, mulch, vinyl or wood siding, etc.
- Only use this fire pit on a level, non-combustible surface.
- Keep away from all combustible materials including gasoline and other flammable liquids and vapors.
- Never use accelerants such as, but not limited to, gasoline, alcohol, paint thinners, kerosene, as this may cause serious injury or product damage.
- Do not overfill or use this unit or use it to burn leaves or trash.
- The fire pit becomes very hot when in use. Use the lid lifter to handle the hot screen. Let the unit completely cool before cleaning or moving.
- Never leave unit unattended while hot or in use.
- Extinguish the fire properly before leaving it unattended. If necessary, use a fire extinguisher or sand to smother the fire. NEVER use water to extinguish hot fires or embers as doing so may cause serious injury and/or permanently damage the product.
- Ashes can remain hot for a long time after fire is extinguished. Dispose of cold ashes properly.
- Ensure the unit is completely cool before covering, failure to do so will damage the cover and the unit.
- DO NOT USE CHEMICAL-BASED CLEANERS as this may damage the product and/or ignite a flame during the next use.
- Contact local authorities regarding possible burn restrictions before using this product.

Any modification to the product or failure to follow recommended care will void the product warranty.

If you experience issues with assembly or the product was damaged during transit, please contact our customer service team through one of the methods mentioned at the top of page 1. Please have the item number and order information ready to expedite response time.

WARNING:

Manufacturer and seller expressly disclaim any and all liability from personal injury, property damage or loss, whether direct or indirect, or incidental, resulting from the incorrect attachment, improper use, inadequate maintenance, or neglect of this product.