

# HULALA

## HOME

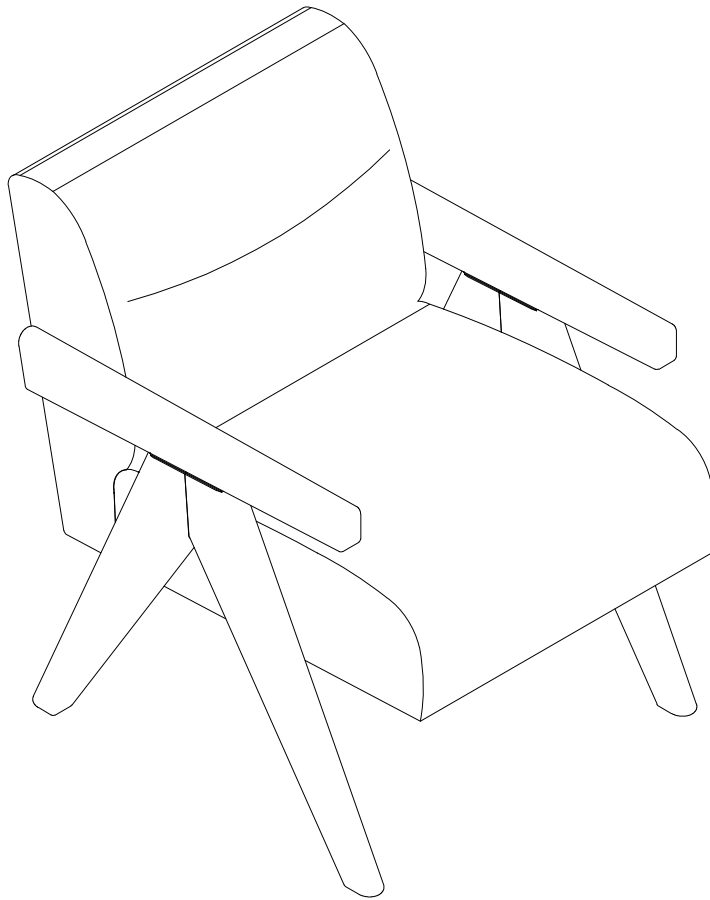

**ITEM NO. CHVT1483**



Per Seat Weight Limitation

**300 LBS**

**Thank You For Choosing Our Furniture**

▾ If you have any questions or concerns,  
don't hesitate to reach out to us. ▴

Call us: +1(833)324-2464  
Email: [hello@hulalahome.com](mailto:hello@hulalahome.com)

**NOTE:**







This brochure contains  
**IMPORTANT** safety info.  
Please read and keep it  
for future reference.

# MAINTAINANCE AND WARNINGS



## Before You Start

***Please follow the steps below:***



-  **Un box the package and check if all parts and accessories are complete.**
-  **Place the parts of the sofa on a flat surface.**
-  **Ensure the sofa is placed on a stable, flat surface to prevent it from tilting.**
-  **Avoid placing sharp or heavy objects directly on the sofa to prevent tears or deformation.**
-  **Follow the assembly instructions provided to attach the cushions, backrest, and armrests securely.**
-  **Clean the installation area in advance and ensure the ground is level and there is enough space to avoid damaging the furniture or making installation difficult.**
-  **Lay a protective mat on the ground to prevent scratching the floor during installation.**

### ***After-Sales Service***

- **If you encounter any issues or need technical support during use, please contact our after-sales team. We offer long-term maintenance and warranty services.**





## Precautions

-  This sofa is for indoor use only. Do not expose it to outdoor elements or high-humidity environments.
-  Keep the sofa away from high heat or open flames to prevent fire hazards.
-  Do not allow children or pets to play on the sofa unsupervised to avoid accidents.



## Safety Warnings

-  If you notice any loose or damaged parts, stop using the sofa immediately and contact customer service.
-  Do not attempt to disassemble or replace any components yourself, as this may affect the stability and safety of the product.

### ***Daily Maintenance***

- Regularly clean the surface of the sofa with a soft cloth to prevent dust accumulation.
- For fabric sofas, it is recommended to vacuum weekly and clean the fabrics as needed.
- For leather sofas, use a leather cleaner regularly to clean and maintain the material. Avoid direct sunlight to prevent leather aging.
- In case of spills, immediately blot the area with a clean, dry cloth.

# Parts List

A

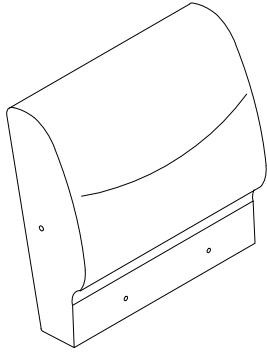

x1

Back frame

B

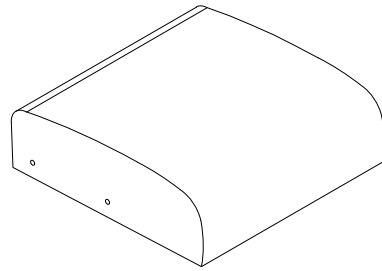

x1

Seat frame

C

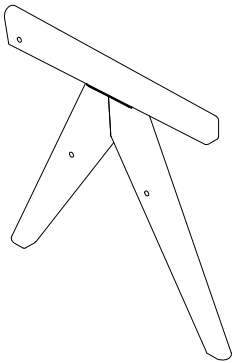

x1

Right Legs

D

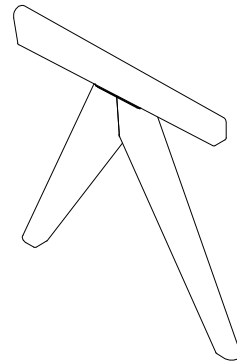

x1

Left Legs



Installation:  
20minutes.



One Person

# Hardware List

1

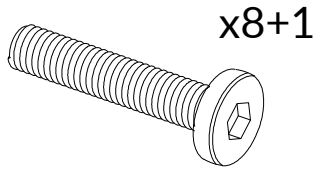

D5\16"xL1-3\4"

2

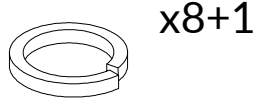

D5\16"

3

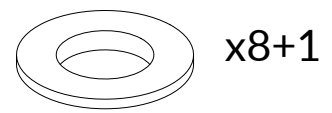

D5\16"





4

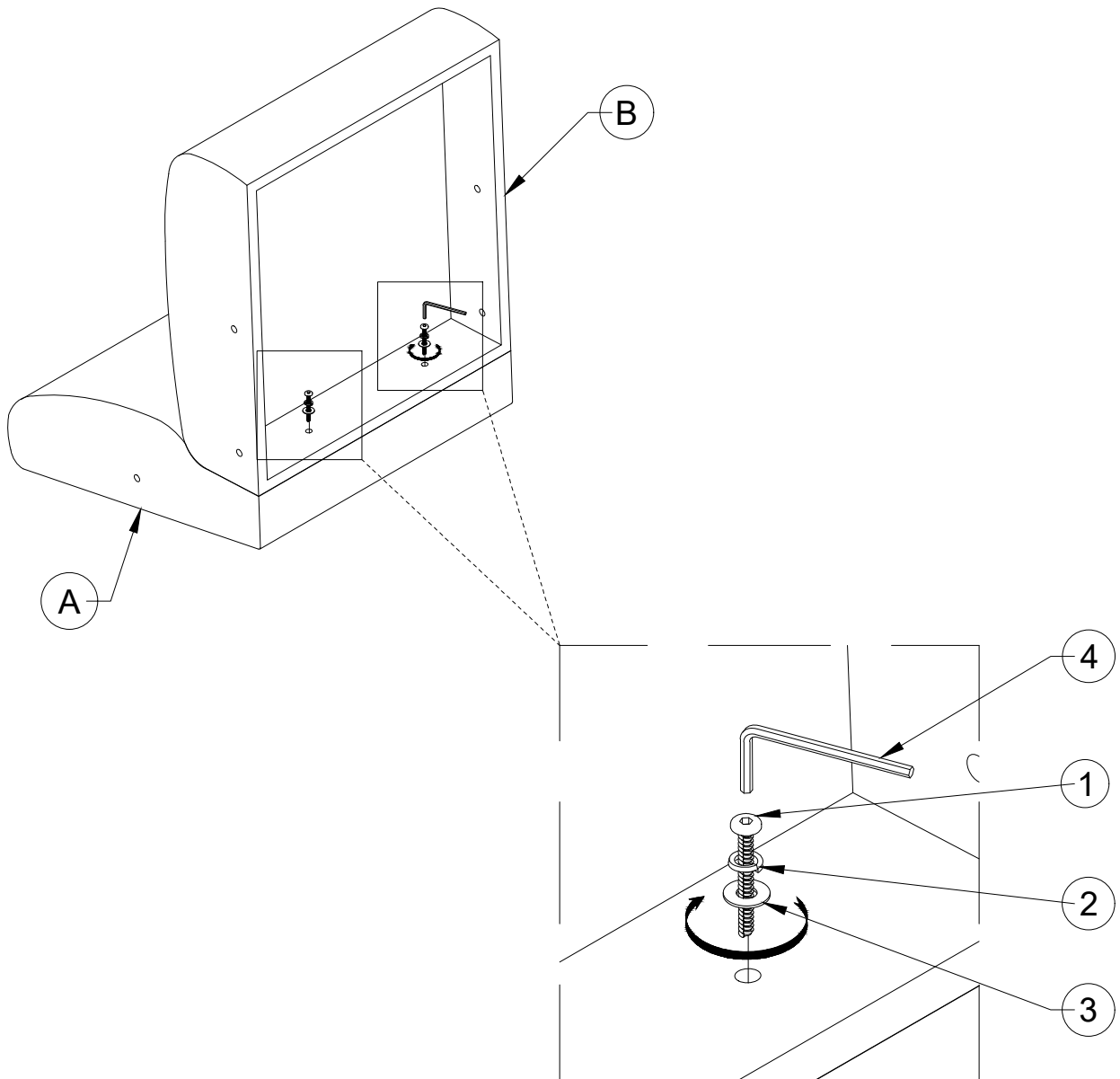

Allen Key M4

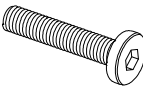



# Step 1

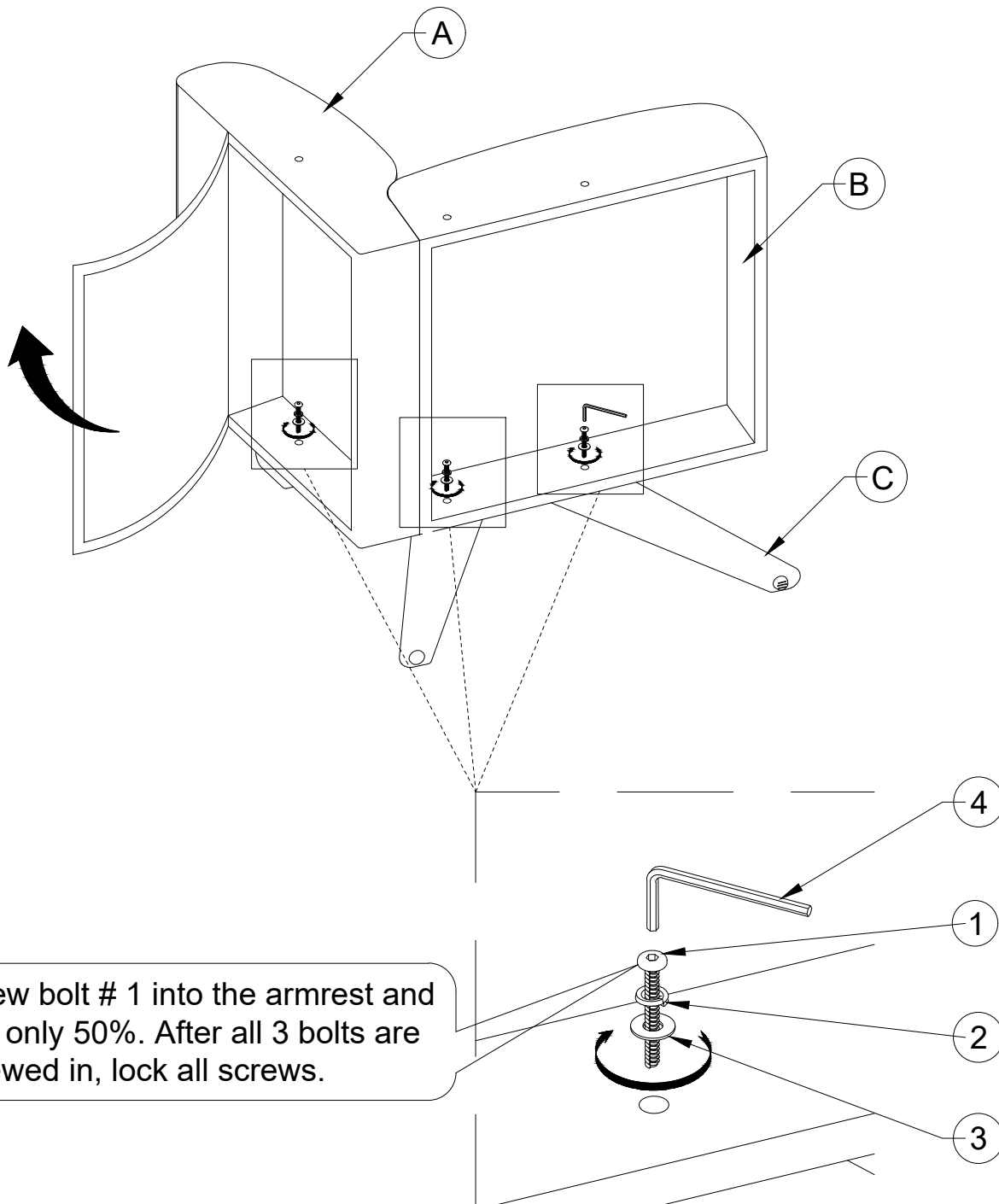

1	x2	2	x2	3	x2	4	x1
							
D5\16"xL1-3\4"		D5\16"		D5\16"		Allen Key M4	

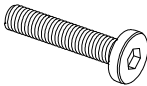
## Step 2

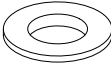



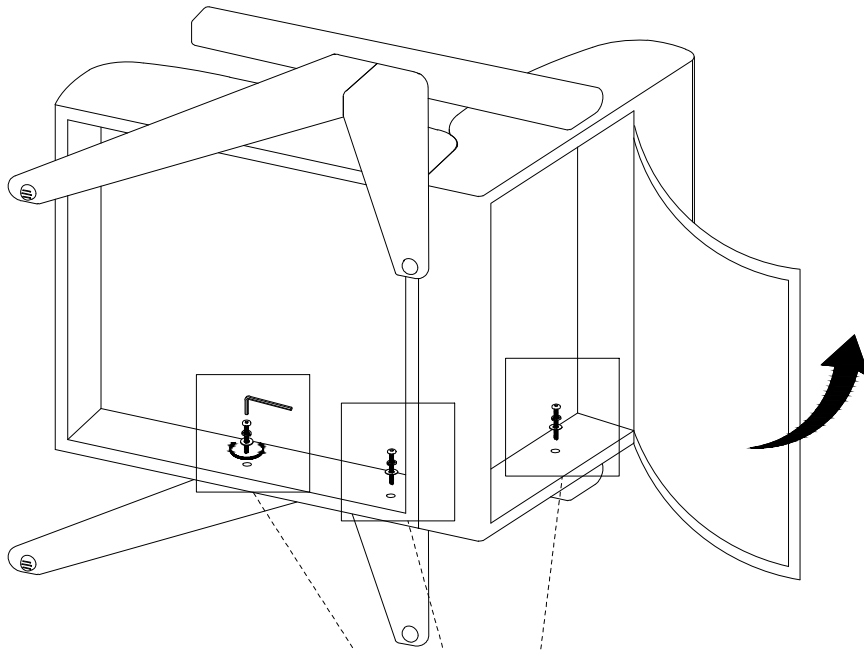

1	x3	2	x3	3	x3	4	x1
							
D5\16"xL1-3\4"		D5\16"		D5\16"		Allen Key M4	

# Step 3

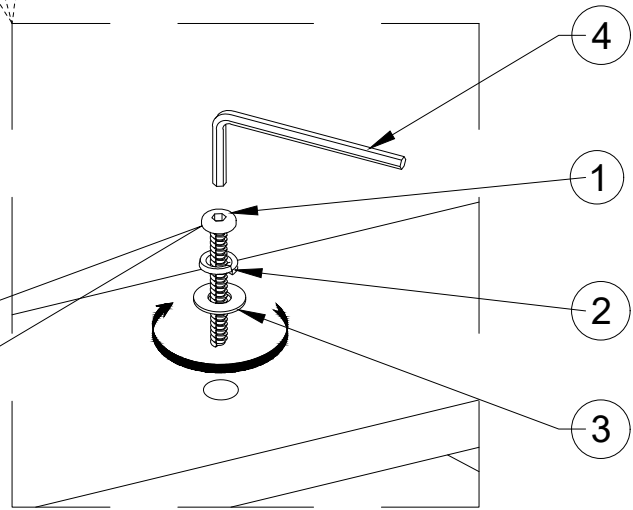

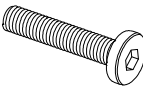
Screw bolt # 1 into the armrest and lock only 50%. After all 3 bolts are screwed in, lock all screws.



1	x3	2	x3	3	x3	4	x1
							
D5\16"xL1-3\4"		D5\16"		D5\16"		Allen Key M4	

## Step 4

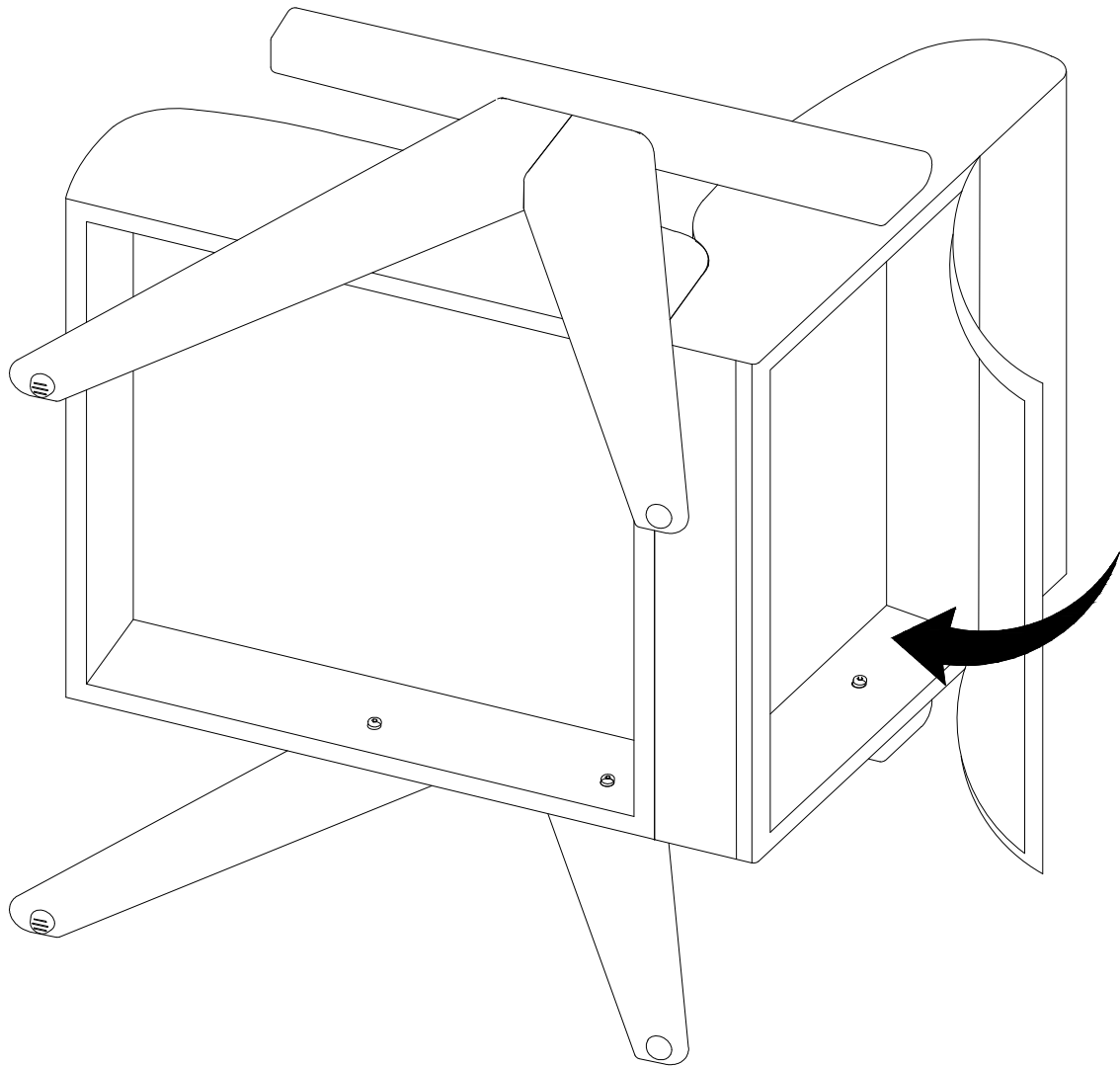

## Step 5



After installation, adjust the adjustable leveler to keep the chair balanced .  
Be sure to check all packing material for small parts, which may have come loose inside the carton during shipment.

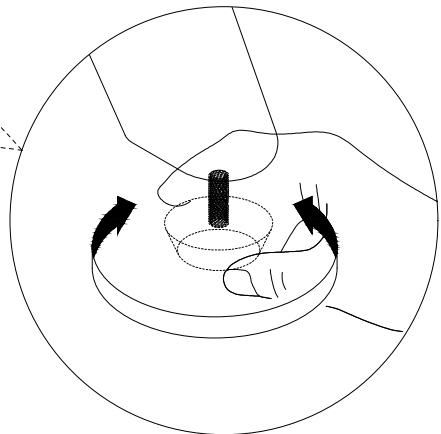
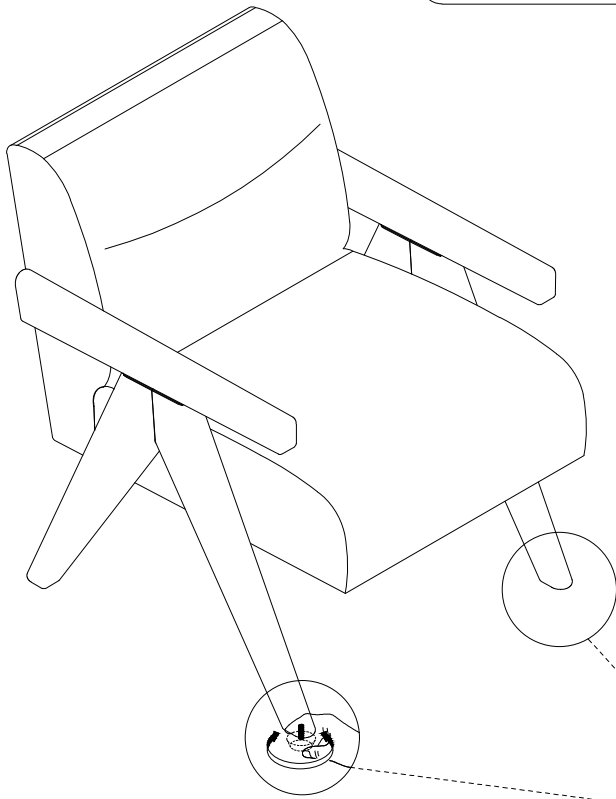

Adjust leveler

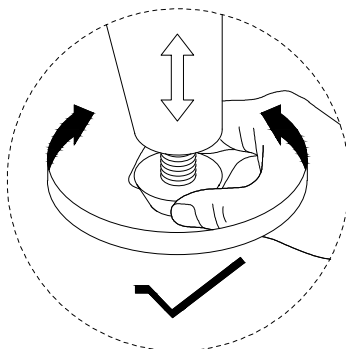
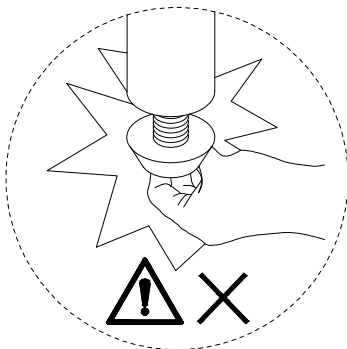

**Step 6**

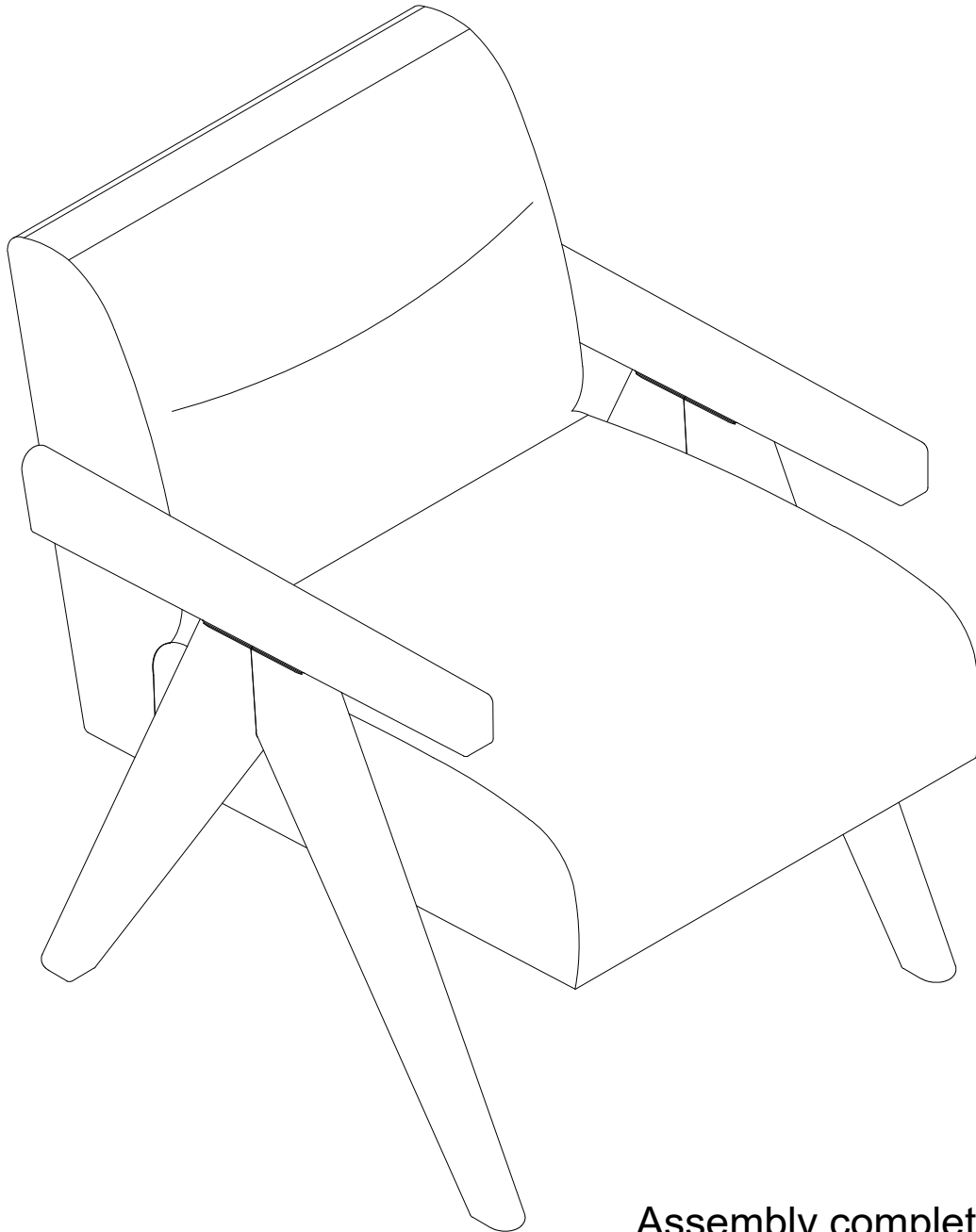

Assembly completed.

# WARRANTY

- We strive to offer quality products, and we also try our best to satisfy every customer who orders from us with products or services as needed.
- We provide 30 days warranty starting from the time you receive the item. Each customer must provide a record of their orders such as the order number, or item receipt for any items that are out of the warranty period you may also still receive.
- Replacement parts by purchasing them from our company if they are available.
- For return, please check the return policy with the retailer or market place you bought from

## ***Are you having difficulty***

**With assembly? Missing parts?  
Please send an email with your order No.to  
[hello@hulalahome.com](mailto:hello@hulalahome.com)**

**Appreciate your purchasing from us.  
Pop up your life by our furniture piece!**