

# Dimension/Specification

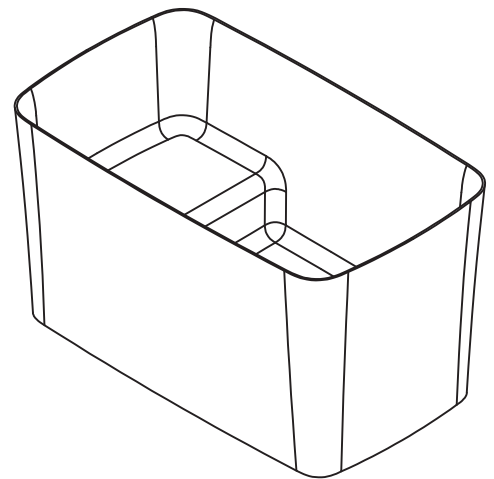
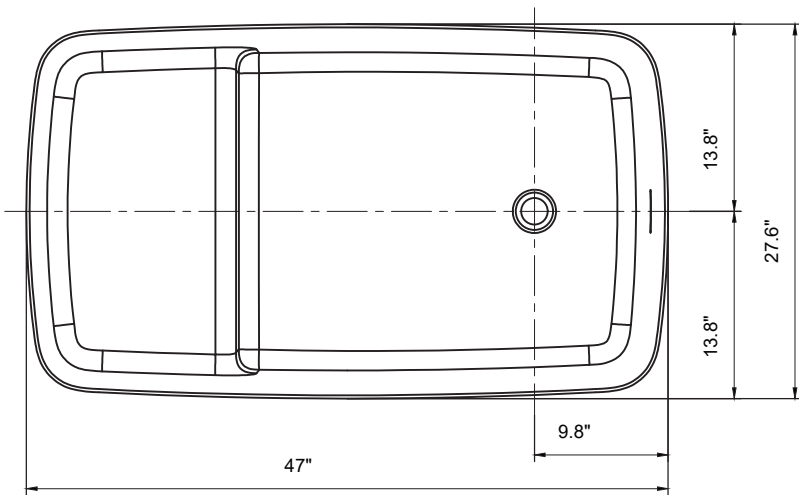
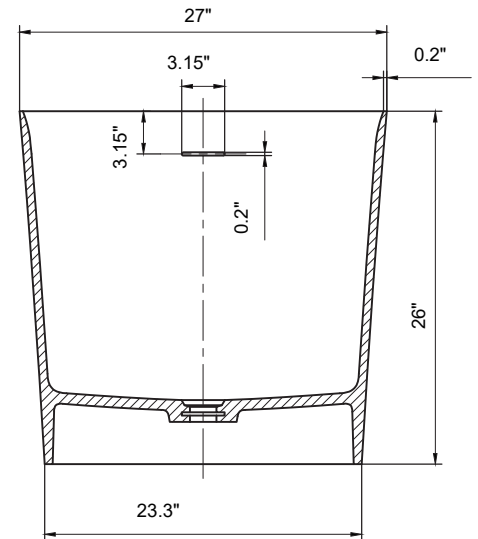
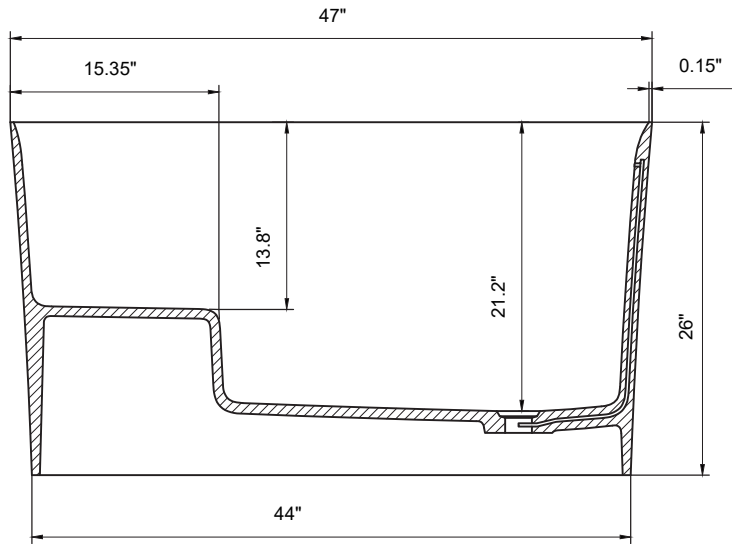

Sku RX-S20-47