

ITEM NO: COFFE TABLE
N735P277298

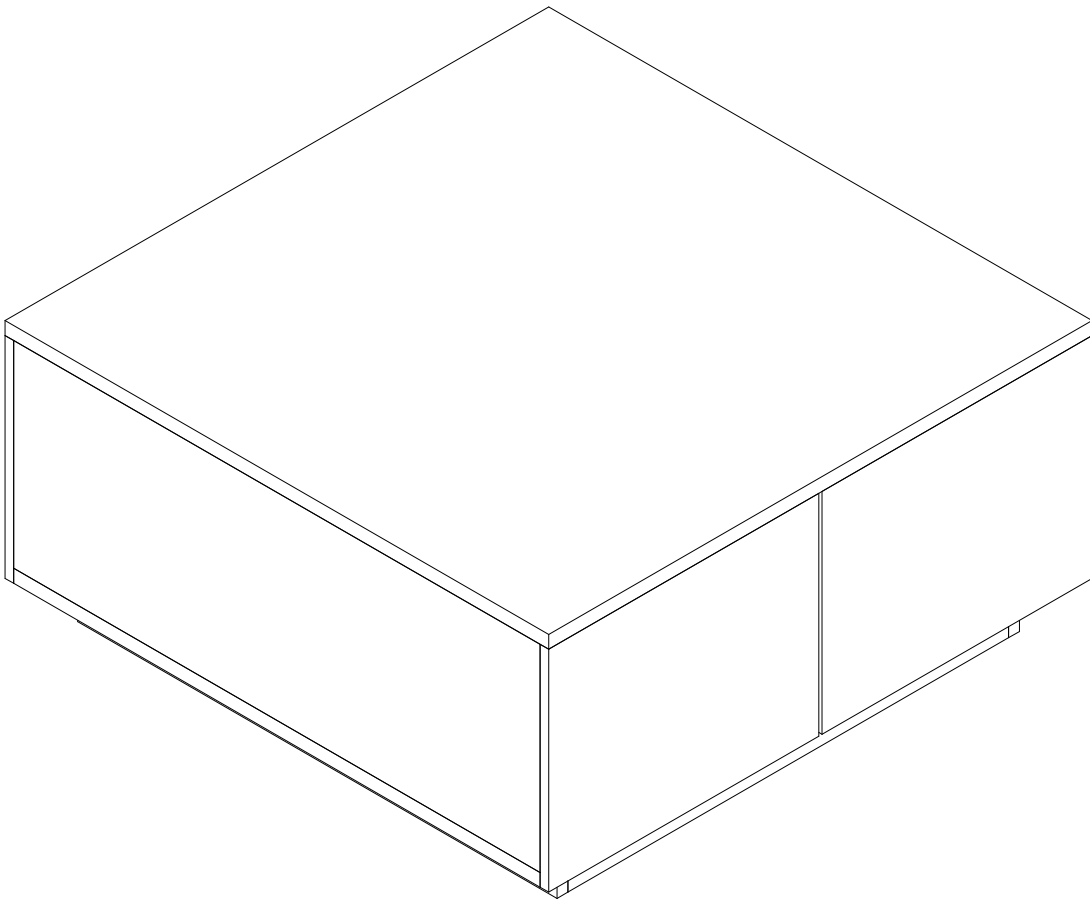

Thank you for choosing our products.

1. Return Policy







DO NOT RETURN TO THE STORE! Skip the process of returning your product and contact us directly for a replacement

If you find that parts of your order are missing or damaged, we will gladly ship any needed replacement parts free of charge.

If you have found any sort of defect, please contact our customer service department and let us know the details of your order and any issues encountered, we will try our best to provide you with a solution.











2. Recommendations Before Beginning Assembly

-  • Read instructions, cover to cover
-  • Have 2-4 adults on hand for assembly depending on product size
-  • Do not assemble directly on flooring or carpet
-  • Assemble on a clean non-marring surface (example: packing foam)
-  • Save all packaging until finished

3. Assembly Notice:

- If you encounter any problems during assembly and find that you cannot continue, rest assured we will help you solve the situation as soon as possible. Simply keep all of the parts of the product stored in a safe place and contact us immediately so we may assist you further.
- Once you have opened your package, remove all inner hardware packages and take the parts out. One by one, Place the parts out neatly in front of you, then refer to the instructions to ensure no parts are missing. If any pieces are found missing, please carefully look in the box first, as the hardware packaging might have torn making the hardware spill in the box.
- Some key parts of your product may be stored and hidden inside of other parts. Please open any zippered or hook & loop storage compartments to remove all parts. (example: cushions and legs being stored in the underside of a sofa)
- **IMPORTANT:** When setting up your product, **DO NOT INSTALL THE SCREWS ALL THE WAY IN THE BEGINNING.** Place each screw into their proper hole and use your hand to twist the screw halfway. Twist all the screws in halfway to ensure the holes will match up properly and the product is level on the ground. When everything seems fitted, then tighten the screws.
- When you have completed assembly, we suggest you have more than one person to assist you with lifting and placing the product.

Care & Maintenance

- ☉  • Do not put hot items directly on furniture surface
- ☉  • Do not clean furniture with harsh cleansers or polish
- ☉  • Do not place furniture under direct sunlight
- ☉  • Do not place furniture near heating or cooling vents
- ☉  • Do not write on furniture without a padded barrier to protect the surface
- ☉  • Do not place furniture outside. For indoor use only
- ☉  • Not for commercial use. For residential use only
- ☉  • Stains may be removed with mild soap solution and damp cloth
- ☉  • Children should not climb or jump on the furniture
- ✓  • Dust and pick-up spills using a clean, non-colored, lint-free cloth

Caution

- This product contains small components. Please ensure that they are kept away from small children.
- Do not use power tools to assemble your furniture. Power tools may strip or damage the parts.

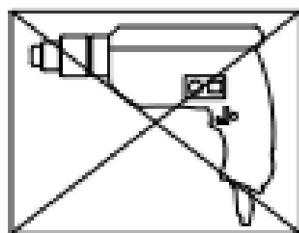

Part List

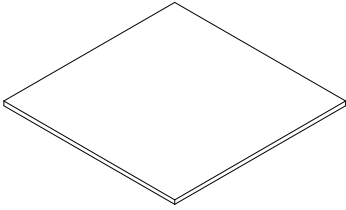
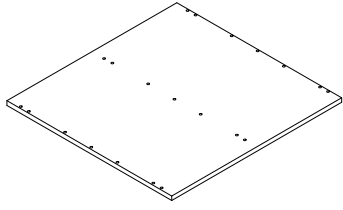
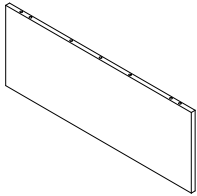
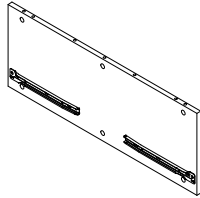
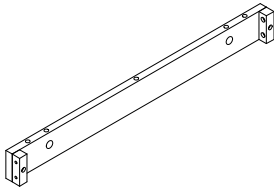
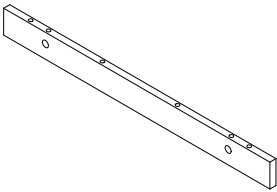
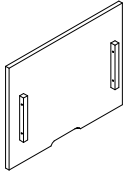
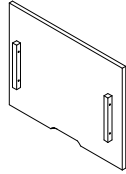
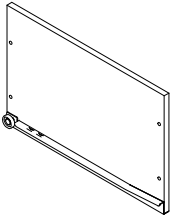
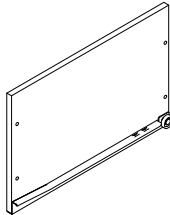
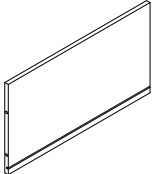
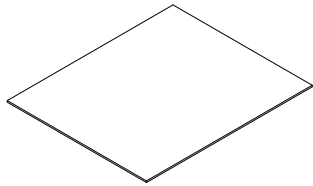
<p>A</p>  <p>Table Top - 1pc</p>	<p>B</p>  <p>Table Bottom - 1pc</p>
<p>C</p>  <p>Side Panel - 2pcs</p>	<p>D</p>  <p>Middle Panel - 1pc</p>
<p>E</p>  <p>Base with Bug - 2pcs</p>	<p>F</p>  <p>Base no Bug - 2pcs</p>
<p>G</p>  <p>Drawer Front - 2pcs Right (R)</p>	<p>H</p>  <p>Drawer Front - 2pcs Left (L)</p>
<p>I</p>  <p>Drawer Side (R) - 4pcs</p>	<p>K</p>  <p>Drawer Side (L) - 4pcs</p>
<p>L</p>  <p>Drawer Back - 4pcs</p>	<p>M</p>  <p>Bottom Drawer Panel - 4pcs</p>

ASSEMBLY TOOLS REQUIRED (NOT INCLUDED)

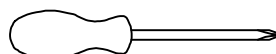

Hardware List

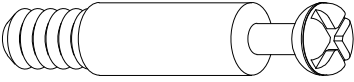
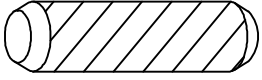
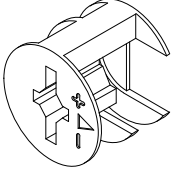
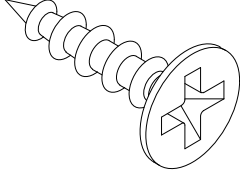
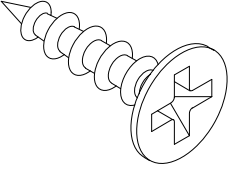
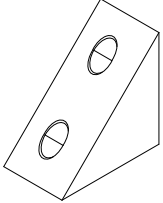
<p>1</p>  <p>ø6x40mm</p>	<p>2</p>  <p>Ø8x30mm</p>
<p>Three in one bolts (26pcs)</p>	<p>Wood dowel (38pcs)</p>
<p>3</p>  <p>ø14.5x12mm</p>	<p>4</p>  <p>#4x20mm</p>
<p>Three in one lock (26pcs)</p>	<p>Screws (36pcs)</p>
<p>5</p>  <p>#4x45mm</p>	<p>6</p> 
<p>Screws (10pcs)</p>	<p>Triangle wood (5pcs)</p>

ASSEMBLY TOOLS REQUIRED (NOT INCLUDED)

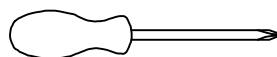

STEP: 1

1	2
9PCS	12PCS

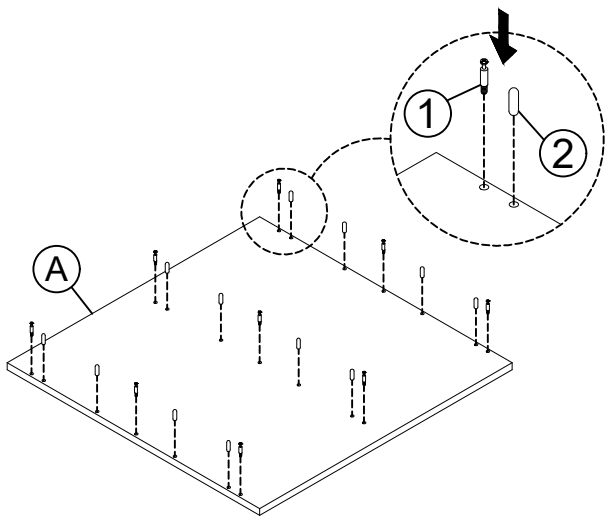

STEP: 2

1	2
9PCS	12PCS

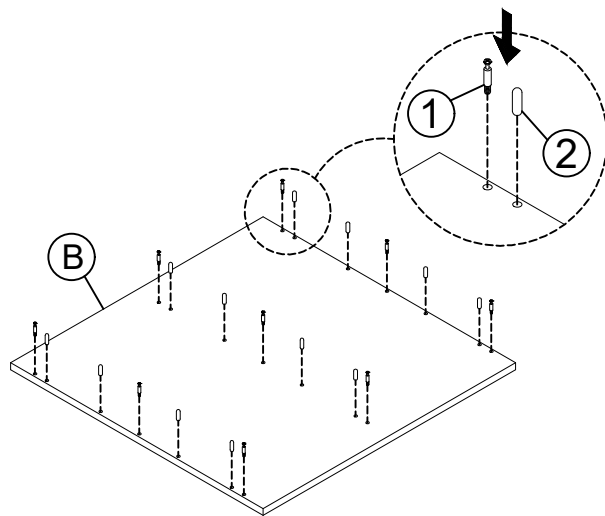

STEP: 3

3	5	6
9PCS	6PCS	3PCS

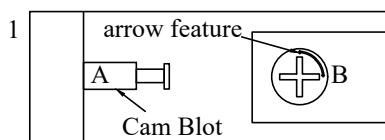
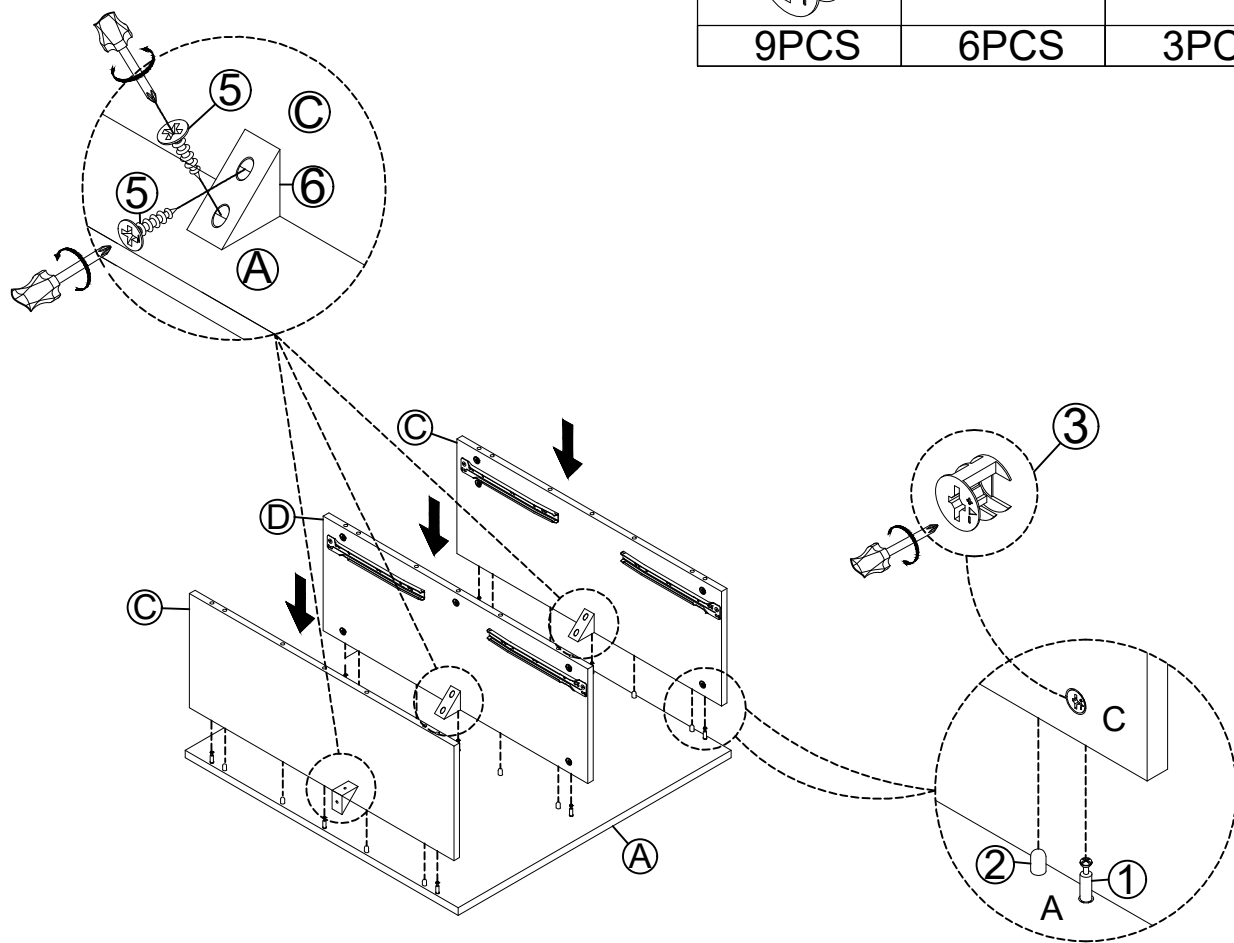

Make sure arrow feature on Cam (B) points to Cam bolt (A)

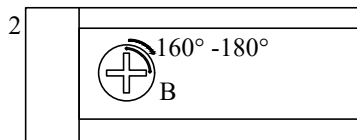

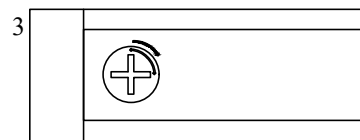

Rotate cam (B) clockwise $160^{\circ} - 180^{\circ}$ to lock parts together.

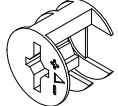
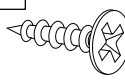

Parts should be tight against each other and connection should be rigid

STEP: 4

3		5		6	
9PCS		4PCS		2PCS	

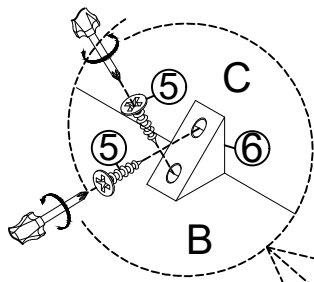

Note: In this step you assemble the Wooden bug (6) onto the Table bottom (B) as in step 4.

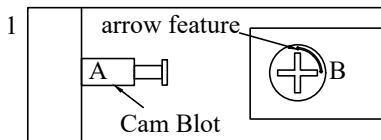
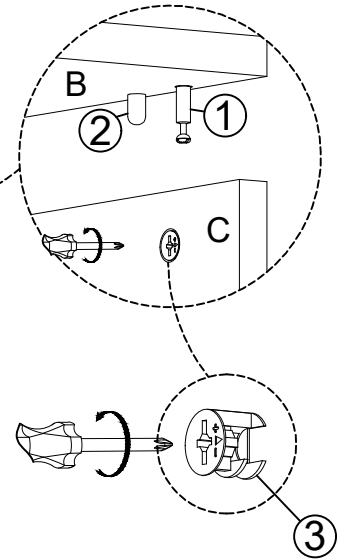
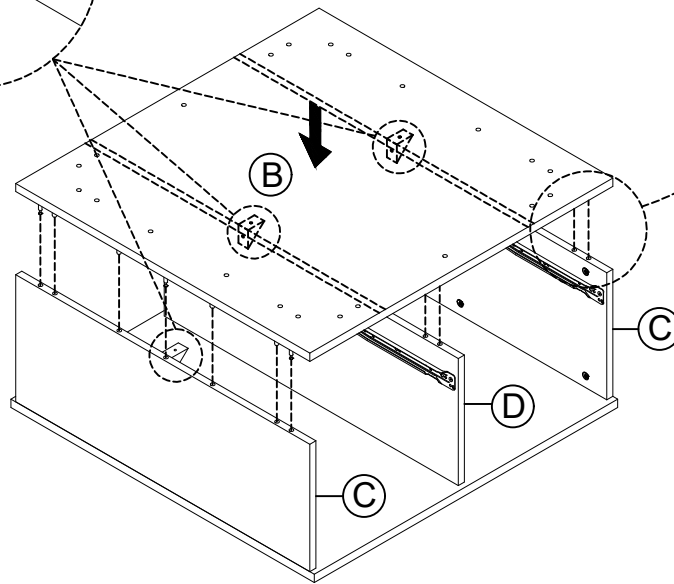

Make sure arrow feature on Cam (B) points to Cam bolt (A)

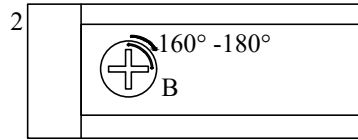

Rotate cam (B) clockwise 160° -180° to lock parts together.

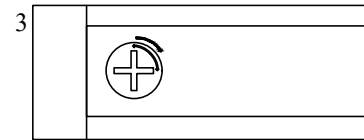

Parts should be tight against each other and connection should be rigid

STEP: 5

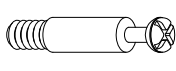
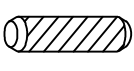
1		2	
8PCS		12PCS	

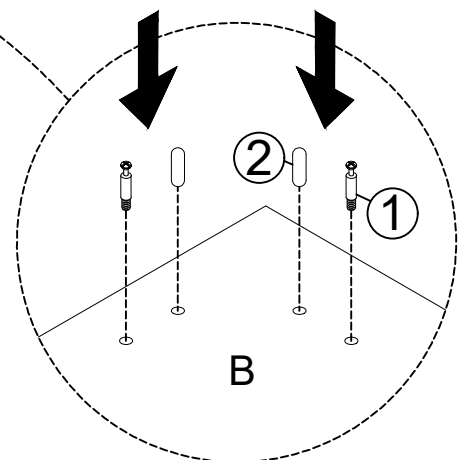
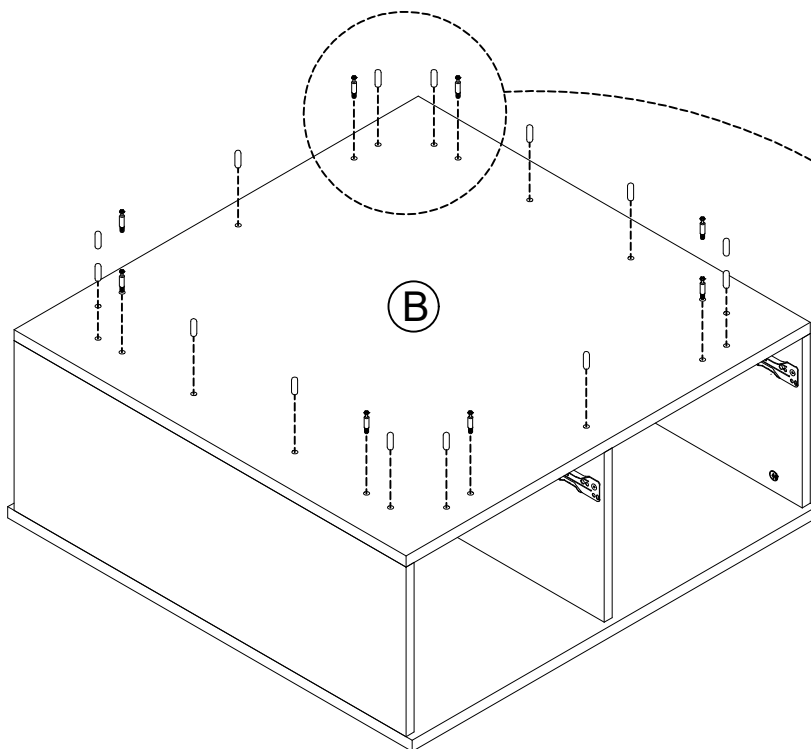

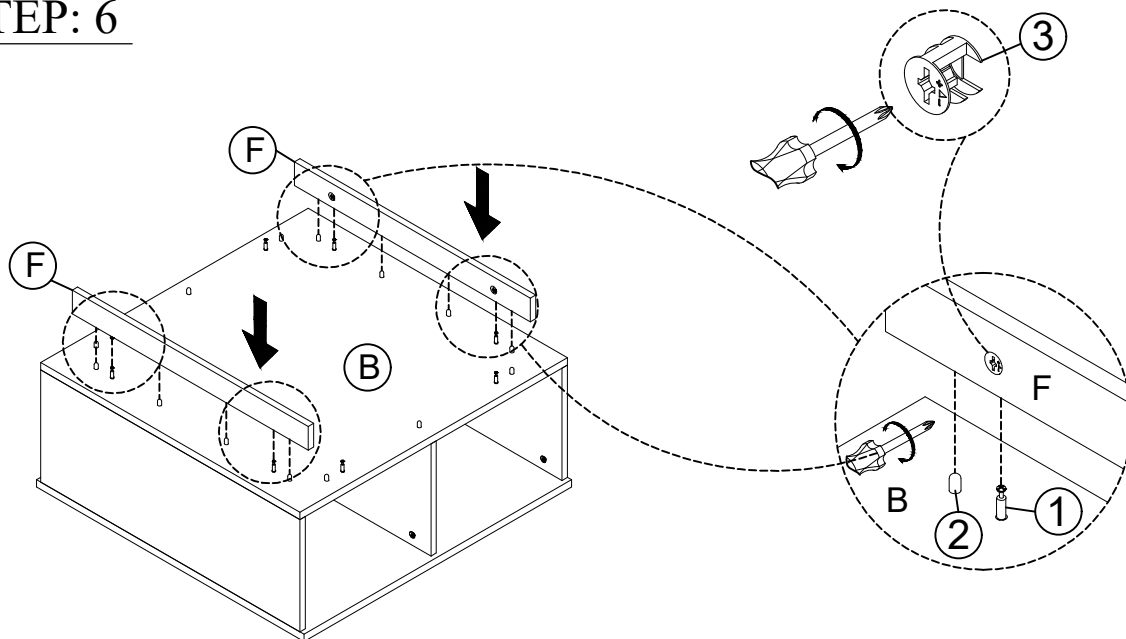

STEP: 6

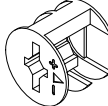

3	
4PCS	

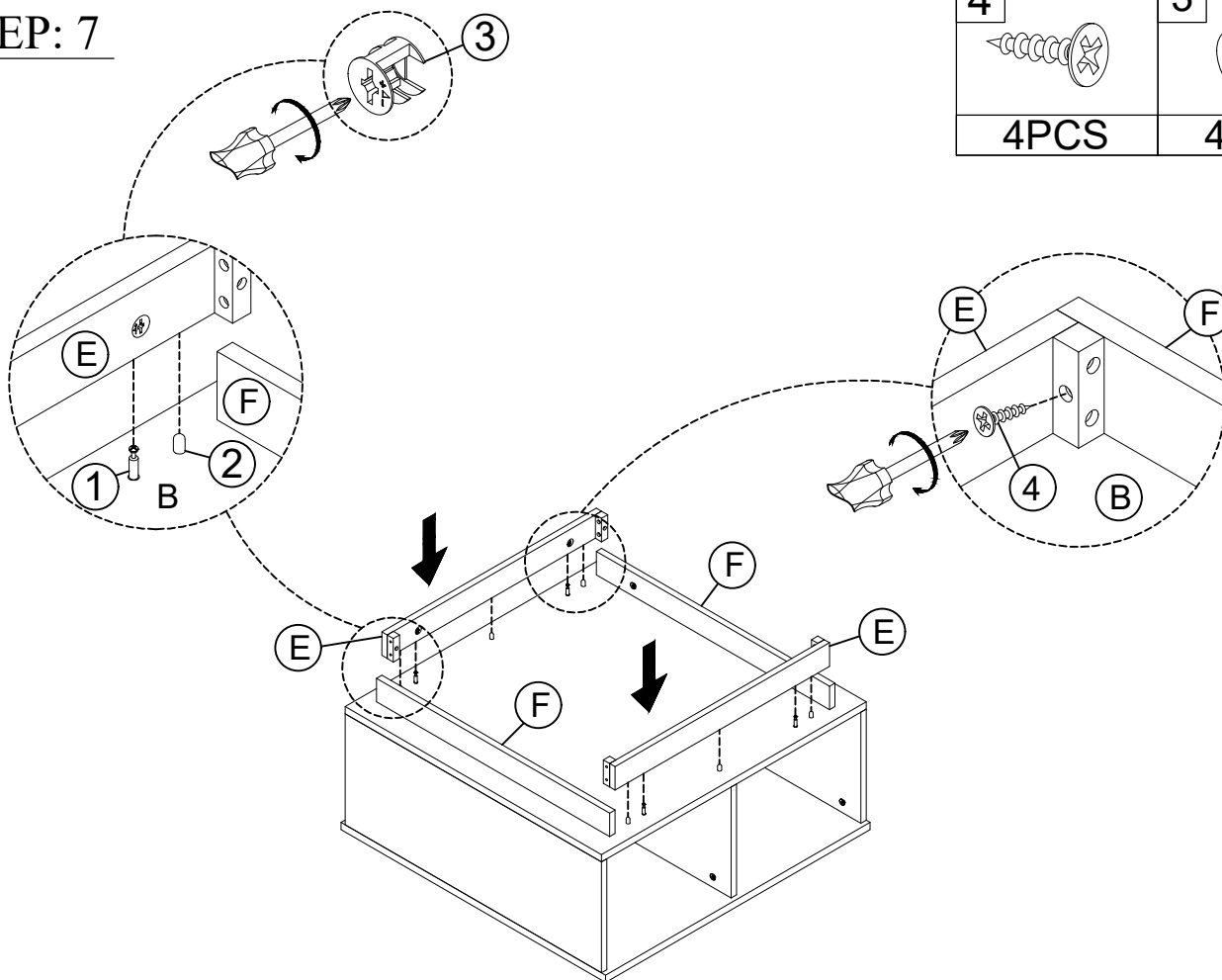
STEP: 7

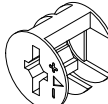

4		3	
4PCS		4PCS	

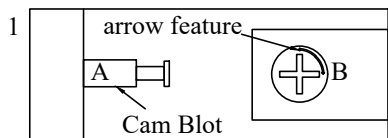

Make sure arrow feature on Cam (B) points to Cam bolt (A)

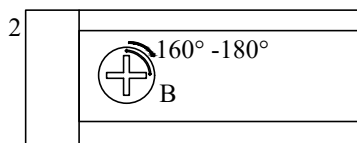

Rotate cam (B) clockwise 160° -180° to lock parts together.

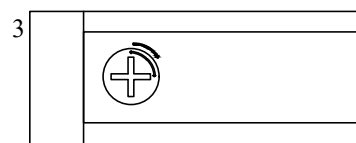

Parts should be tight against each other and connection should be rigid

STEP: 8

4

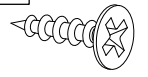

32PCS

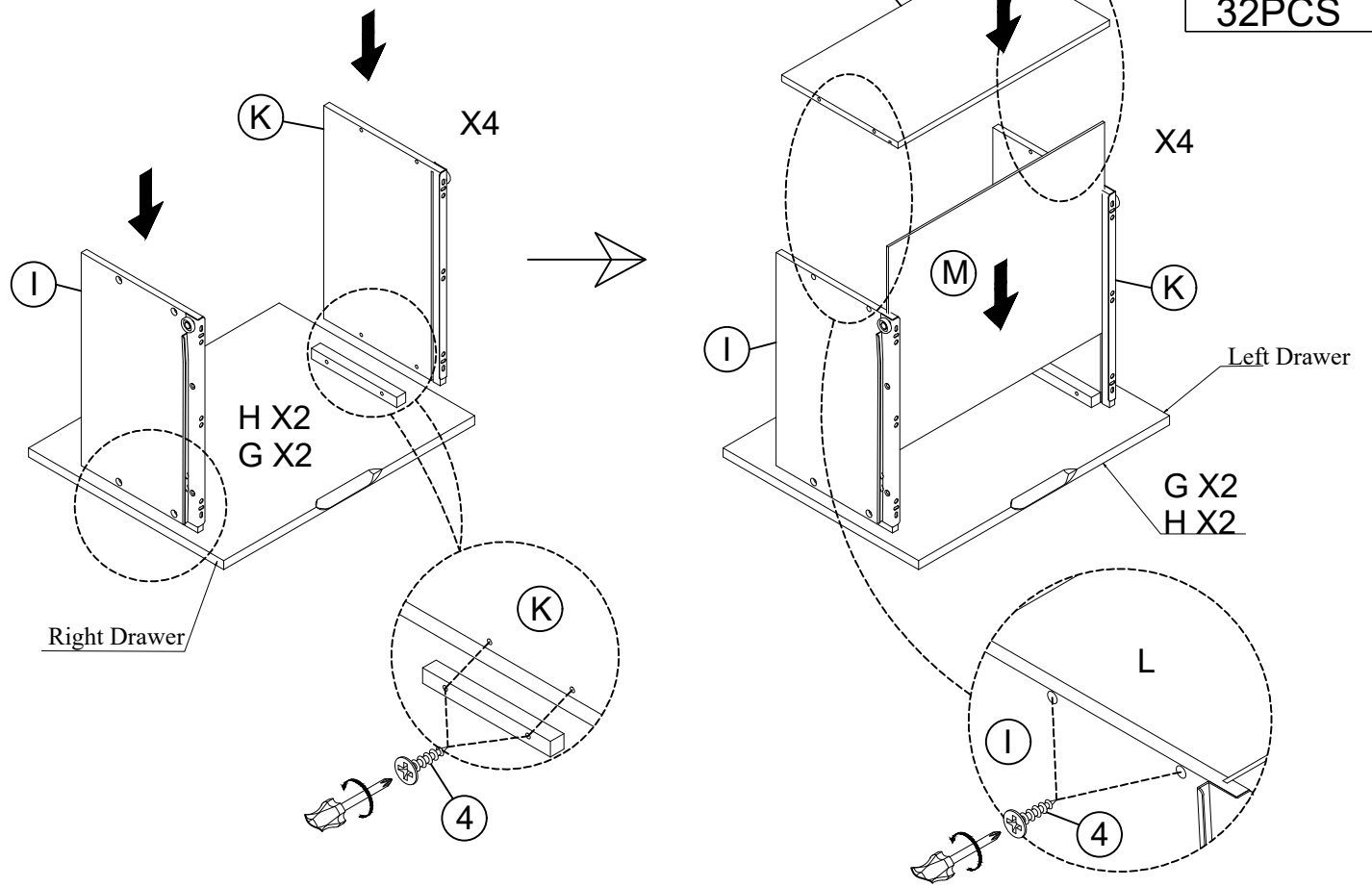

COMPLETED:

