

ELECTRIC FIREPLACE

HOMEOWNERS OPERATING MANUAL

Figure: The object is the main object.

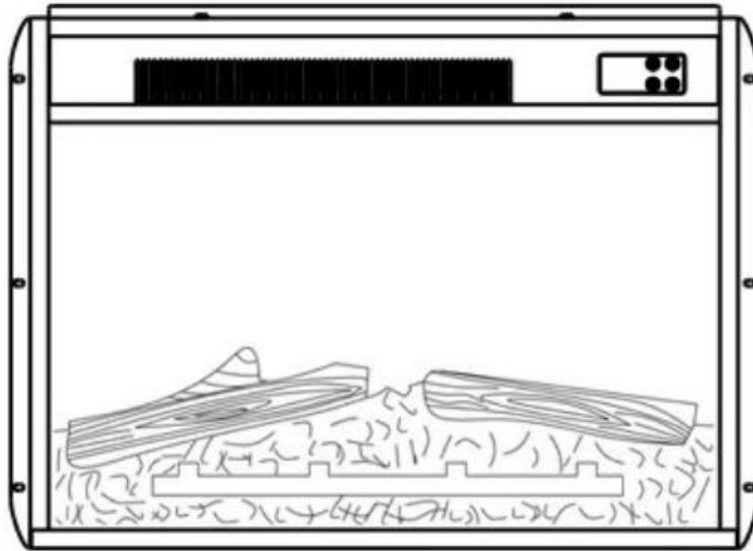

CONSUMER SAFETY INFORMATION:

Please read this manual before installing and operating this appliance. Failure to follow these instructions may result in electric shock, fire hazard or injury and will void the warranty.

WARNING:

If the information in this manual is not followed, electrical shock or fire may result in property damage, personal injury, or loss of life.

This instruction manual contains important safety information. Please read and save it for future reference.

IMPORTANT INSTRUCTIONS:

When using electrical appliances, basic precautions should always be followed to reduce the risk of fire, electrical shock, and/or injury including the following:

1. Read all instructions before using this heater.
2. This heater is hot when in use. To avoid burns, do not let bare skin touch hot surfaces. If provided, use handles when moving this heater.

DANGER: High temperature may be generated under certain abnormal conditions. Do not partially or fully cover or obstruct the front of the heater.

WARNING: In order to avoid overheating, do not cover the heater. It cannot be used in a closet.

3. CAUTION: The appliance should not be used by children or persons with reduced physical, sensory or mental capabilities.

4. Children should be advised not to play with the appliance.

5. Always unplug this appliance when not in use.
6. Do not operate any heater with a damaged cord or plug or after the appliance malfunctions, or if it has been dropped or damaged in any manner.
7. If the supply cord is damaged, it must be replaced by the manufacturer, its service agent or similarly qualified persons in order to avoid a hazard.
8. Any repairs to this fireplace should be carried out by a qualified service person.
9. Under no circumstances should this fireplace be modified. Parts having to be removed for servicing must be replaced prior to operating this fireplace again.
10. Do not use outdoors.
11. This heater is not intended for use in bathrooms, laundry areas and similar indoor locations. Never locate this appliance where it may fall into a bathtub or other water container.
12. Do not run cord under carpeting. Do not cover cord with throw rugs, runners or the like. Arrange cord away from traffic areas and where it will not be tripped over.
13. To disconnect this appliance, turn controls to the off position, then remove plug from outlet.
14. Connect to properly grounded outlet only.
15. This appliance, when installed, must be electrically grounded in accordance with local codes or, in the absence of local codes, with the current CSA C22.1 Canadian Electrical Code or for USA installations, follow local codes and the National Electrical Code, ANSI/NFPA NO.70.
16. There is a protective thermostat limiter inside the heater. When the inner temperature overheat, the thermostat limiter will shut off the power supply to avoid the risk of fire damage to the appliance.
17. The heaters must not be located immediately below a socket-outlet.
18. Do not insert or allow foreign objects to enter any ventilation or exhaust opening as this may cause an electric shock or fire, or damage the appliance.
19. To prevent a possible fire, do not block air intake or exhaust in any manner. Do not use on soft surfaces, like beds, where openings may become blocked.
20. This appliance has hot and arcing or sparking parts inside. Do not use where gasoline, paint, or flammable liquids are used or stored. This fireplace should not be used as a drying rack for clothing. Christmas stockings or decorations should not be hung in area of it.
21. Use this appliance only as described in the manual. Any other use not recommended by the manufacturer may cause fire, electric shock or injury to persons.
22. Always plug heaters directly into a wall outlet/receptacle. Never use with an extension cord or relocatable power tap (outlet/power strip)

There are two ways to operate the electric fireplace:

* **Keyboard operation of electric fireplace.**

* **Remote control operation.**

The keyboard is above or below the right of the electric fireplace. (See Figure 1) .

Figure 1

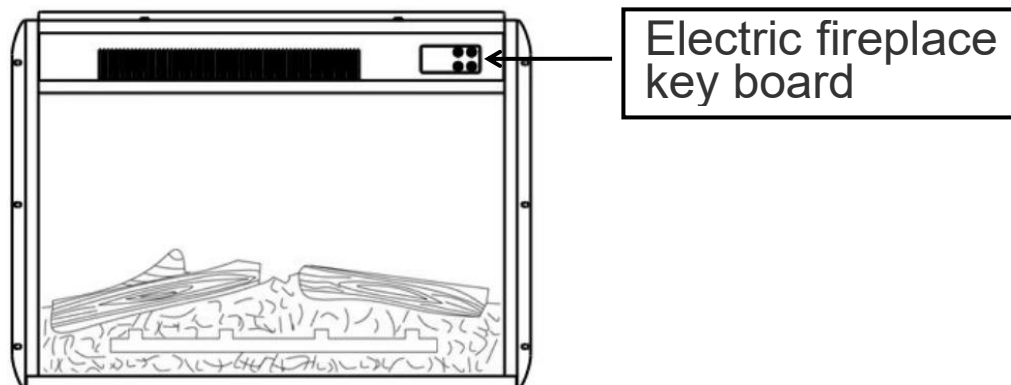

***Keyboard operation of the electric fireplace.**

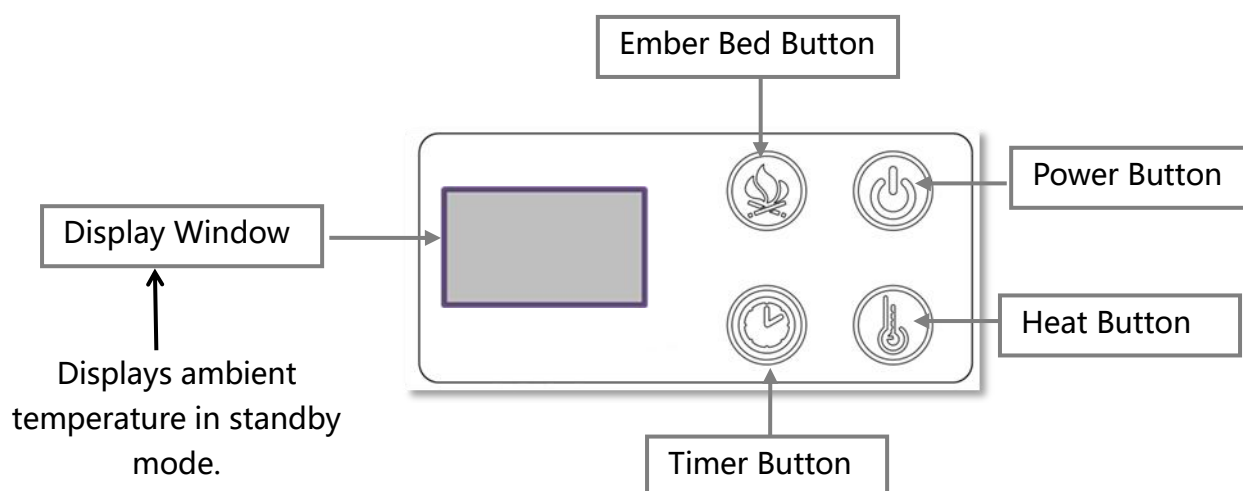





Technical Specification

Product name: Electric fireplace





Supply: 120V AC 60Hz

Rated power: 1500W

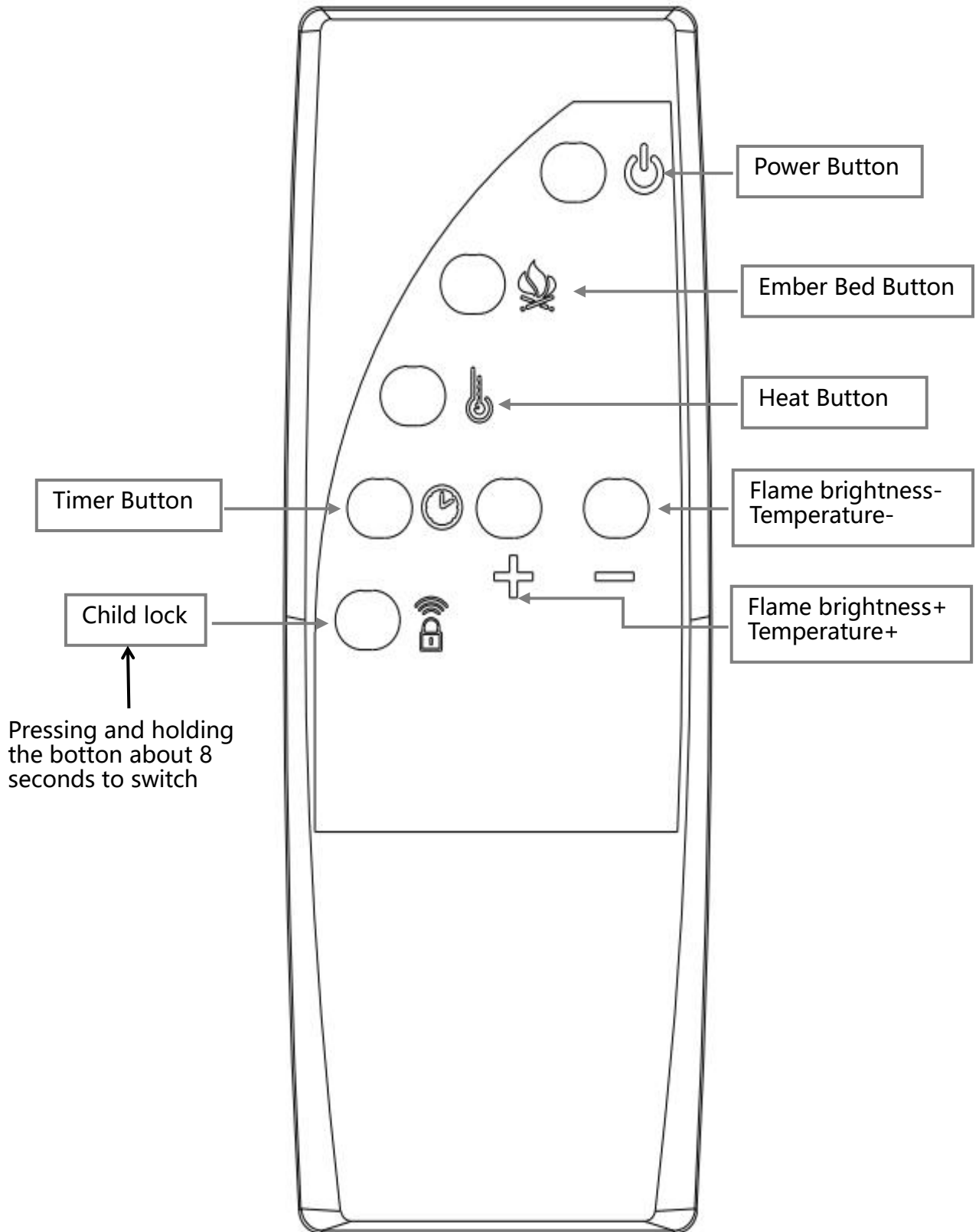
	<p>Power on/off Button: Short press to turn the fireplace on or off.</p>
	<p>Flame Button:</p> <p>1. For a monochrome flame fireplace, a short press of the flame key adjusts the mode (P/R/H - R for constant flame, P for breathing flame, H for fixed flame).</p>
	<p>Heating Button:</p> <p>1. Short press the heating button to turn on the heating function. The indicator light next to the heating button will turn red, and the display will show "ON". Press the heating button again to turn off the heating function, and the display will show "OFF".</p> <p>2. In the heating on state, long press the heating button for 2 seconds. The display will show "37", and then you can begin setting the temperature. The temperature can be set from 99-95-90-85-80-75-70-65-60(9 levels of temperature setting), in a continuous loop.</p> <p>When the heating temperature is displayed at 99-95-90-85-80-75-70-65-60, Long press the heating button on the remote control for 5 seconds to switch to °C(37-35-32-29-27-24-21-18-16)</p> <p>A. When the display shows "ON", the heating is not affected by the room temperature, and the heater will continue to work without automatically stopping.</p> <p>B. When any of the temperatures 99-95-90-85-80-75-70-65-60 is displayed. The heater will stop working, if the room temperature is greater than or equal to the displayed temperature.</p> <p>3. Press and hold the heating button for 5 seconds to switch the temperature between °F and °C.</p>
	<p>Timer Button:</p> <p>1. Short press the timer button to activate the timer function. The digital display will show "0H". Press the timer button again to set the timer. The setting range is from 1 hour to 9 hours, and the indicator light next to the timer button will turn red to indicate that the timer function is in progress.</p>
	<p>Digital Display: Displays the corresponding function.</p>

Remote control operation



BUTTON	FUNCTION
 POWER	Power on/off Button: Short press to turn the fireplace on or off.
 FLAME	<p>Flame Color Button:</p> <p>For a monochrome flame fireplace, a short press of the flame key adjusts the mode (P/R/H) R is the flame effect, The flame has 5 levels of brightness, you can press the keys '+' '-' to adjust the brightness after pressing the flame button. L1-L2-L3-L4-L5, P for breathing flame, H for fixed flame).</p>
 HEATE	<p>Heating Button:</p> <p>1. Short press the heating button to turn on the heating function. The indicator light next to the heating button will turn red, and the display will show "ON". Press the heating button again to turn off the heating function, and the display will show "OFF".</p> <p>2. In the heating on state, long press the heating button for 2 seconds. The display will show "99", and then you can begin setting the temperature. The temperature can be set from 99-95-90-85-80-75-70-65-60 (9 levels of temperature setting), in a continuous loop.</p> <p>When the heating temperature is displayed at 99-95-90-85-80-75-70-65-60, Long press the heating button on the remote control for 5 seconds to switch to °C (37-35-32-29-27-24-21-18-16)</p> <p>A. When the display shows "ON", the heating is not affected by the room temperature, and the heater will continue to work without automatically stopping.</p> <p>B. When any of the temperatures 99-95-90-85-80-75-70-65-60 is displayed. The heater will stop working, if the room temperature is greater than or equal to the displayed temperature.</p> <p>3. Press and hold the heating button for 5 seconds to switch the temperature between °F and °C.</p>
 TIMER	<p>Timer Button:</p> <p>1. Short press the timer button to activate the timer function. The digital display will show "0H". Press the timer button again to set the timer. 0H-1H-2H-3H-3H-5H-6H-7H-8H-9H</p>
 Key Lock	<p>Key Lock</p> <p>Long press the lock button for 8 seconds to activate the "Lock function". The digital display shows "--", and except for the normal on/off function, all other functions cannot be operated. Press the lock button for 8 seconds again to deactivate the "Lock function," and all functions can be used normally.</p>

 <p>"+" "-" Keys</p>	<p>"+" and "-" Keys:</p> <ol style="list-style-type: none">1. When setting the flame brightness (after pressing the flame button), use the "+" or "-" keys to adjust the flame brightness.2. When setting the heating temperature (after pressing the heating button), use the "+" or "-" keys to adjust the heating temperature.
---	--

***Edge strip installation instructions:**

- The side strips are not divided into left and right sides, and there are 3 screws on each side, See Fig.

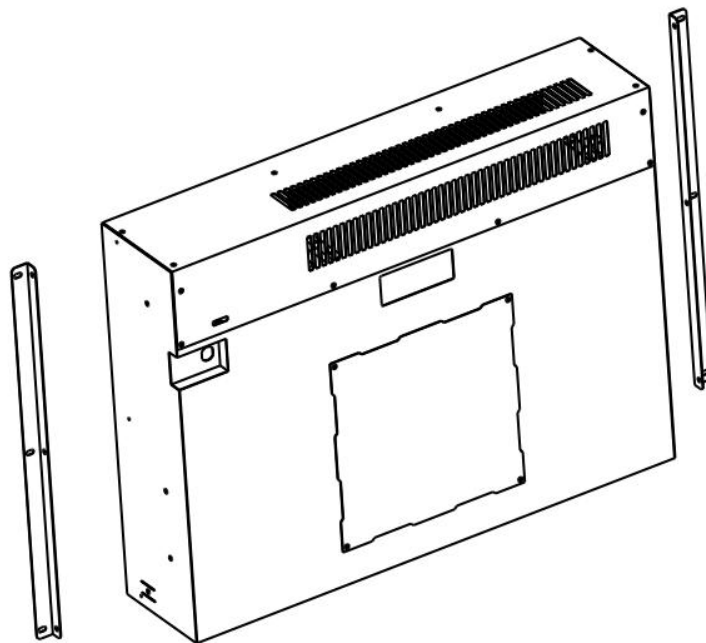

DO NOT mix old and new batteries.

DO NOT use rechargeable silver oxide cell batteries with remote control unit.

DO NOT mix alkaline. Standard (Carbon-zinc). Or rechargeable (Nickle - Cadmium) batteries.

DO NOT dispose of batteries in fire. Improper disposal may cause batteries to leak or explode.

Important Safety Instructions

When using this electrical appliance, basic precautions should be followed to reduce the risk of fire, electric shock, and injury to person, including the following :

- This heater must be used on an AC supply only and the voltage marked on the heater must correspond to the supply voltage.
- Do not switch the appliance on until it properly installed and described in this manual.
- Do not leave the appliance unattended during use.
- Do not leave the appliance unattended whilst connected to the mains supply.
- Keep out of reach of children and do not allow them to operate this appliance.
- From time to time, check the cord for damage .Never use the appliance if the cord or any part of the appliance shows signs of damage.
- Do not operate this appliance with a damaged plug or cord, after a malfunction or after being dropped or damaged in any way.
- Repairs to electrical appliances should only be performed by a qualified electrician.
Improper repairs may place the user at serious risk.
- Do not run the cable under carpets, rugs etc.
- Do not allow the mains cable to hang over sharp edges or come into contact with hot surfaces.
- **WARNING:** In order to avoid overheating, do not cover or obstruct the heater in any way.
- Overheating will result if it is accidentally covered.
- Never immerse the product in water or any other liquids.

LED Bulb Replacement

Note: The flame effect on this electric fireplace insert is created by LED Bulbs.

The life of these LED bulbs will be 100,000 hours. The users are not recommended to Replace the LED Bulbs. For any reason should the bulbs stop working properly, contact a Qualified technician.

Cleaning:

- Turn heater OFF and unplug from electrical outlet before any cleaning or maintenance is performed. Wait at least 10 minutes to allow all components to cool properly.
- Use a vacuum or duster to keep heater and vent area clean from dust and dirt.
- The exterior of the fireplace should be cleaned with a damp cloth or duster.
Do not use abrasive cleaners or liquid sprays.

WARNINGS AND CAUTIONS

WARNING To avoid electrical shock not open the back panel of the insert unless the Power has been turned off. And the insert has been unplugged.

WARNING Any electrical repairs.to this electric fireplace. Should only be Performed by a qualified technician.

WARNING Any electrical wiring repairs should only be performed by a qualified Technician. And also must comply with local buildings codes.

WARNING Discontinue use of this electric fireplace if any of the follow has Occurred: Water damage. If insert has been or dented. If power cord has Become broken. If power cord becomes hot to touch, if unit smokes or Smells like smoke.

Note: When the heat functions is used for the first time. A slight odor may be Present. This is normal and should be occur again unless heater is not used For extended periods of time and dust is allowed to accumulate on heater Element.

Technical Specification

- Supply: 120V/60Hz
- Rated power:1500W

Meaning of crossed - out wheeled dustbin:

Do not dispose of electrical appliances as unsorted municipal waste, use separate collection facilities.

Safety Cut-Off

- This appliance is fitted with a safety cut-off which will operate if the fire overheats (e.g. due to blocked air vents) .For safety reasons, the fire will NOT automatically reset.
- To reset the appliance, disconnect the appliance from the mains supply for at least 15 minutes. Reconnect the supply to the mains and switch on the appliance.

Troubleshooting

Symptom	Solution
No operation/no fan,	Check fuse by replacement, Check for safety cut-off operation,
No fire effect light,	Check the LED light with technician.

Meaning of crossed –out wheeled dustbin:

Do not dispose of electrical appliances as unsorted municipal waste, use separate collection facilities.

Contact you local government for information regarding the collection systems available.

If electrical appliances are disposed of in landfills or dumps, hazardous substances can leak into the groundwater and get into the food chain, damaging your health and well-being.

When replacing old appliances with new ones, the retailer is legally obligated to take back your old appliance for disposals at least free of charge.

MADE IN CHINA