

MODEL: IG10600013-1113



OWNER'S MANUAL

Rosewood 11' x 13' Cedar Framed Hard Top Gazebo

TABLE OF CONTENTS

ASSEMBLY GUIDE.....	02
USING YOUR PRODUCT.....	05

December 17, 2024

QUESTIONS?



E-mail: support@modernshade.org











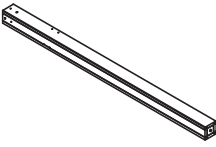
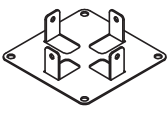
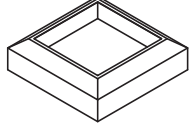
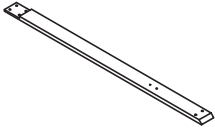
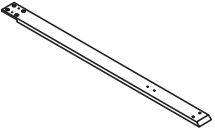
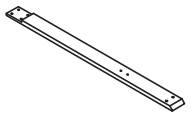
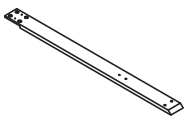
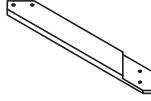
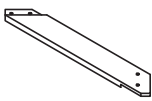

Toll Free: 1-888-666-3070

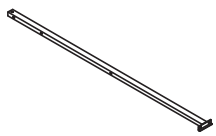
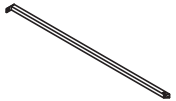
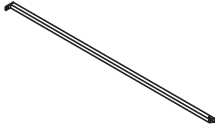
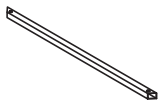
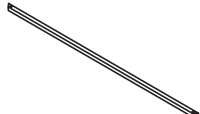
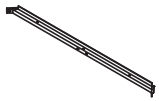
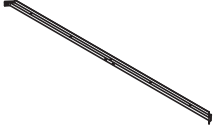
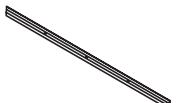
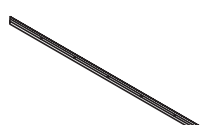

Mon-Fri: 9am---5pm PST.

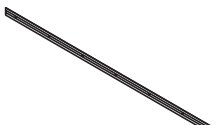
ASSEMBLY GUIDE

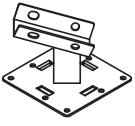
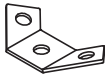
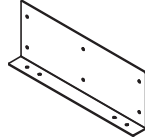
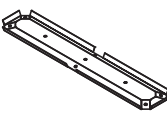
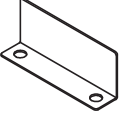
PARTS LIST

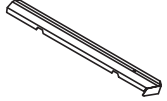
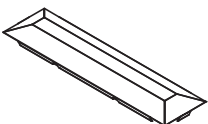
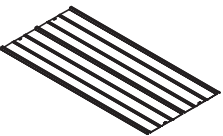
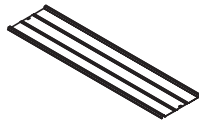
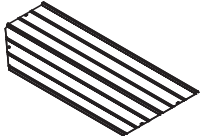
A1 Post 1 (4 pieces) 	B Foot Base (4 pieces) 	C Foot Cover (4 pieces) 	D1 Cross Beam 1 (2 pieces) 	D2 Cross Beam 2 (2 pieces) 	D3 Cross Beam 3 (2 pieces) 
P0010000701	P0030000301	P0020000301	P0040001501	P0040001601	P0040001701
D4 Cross Beam 4 (2 pieces) 	E1 Support Bracket 1 (4 pieces) 	E2 Support Bracket 2 (4 pieces) 	F1 Roof Rib 1 (4 pieces) 	F3 Roof Rib 3 (4 pieces) 	G1 Middle Cross Beam 1 (4 pieces) 
P0040001801	P0050000501	P0050000601	P0070000202	P0070000701	P0080000601
H5 Roof Support 5 (4 pieces) 	H6 Roof Support 6 (4 pieces) 	H9 Roof Support 9 (2 pieces) 	H10 Roof Support 10 (2 pieces) 	J3 Roof Upper Border 3 (2 pieces) 	J4 Roof Upper Border 4 (2 pieces) 
P0090002301	P0090002401	P0090002701	P0090002801	P0090003301	P0090003401
K3 Roof Top Border 3 (2 pieces) 	K4 Roof Top Border 4 (2 pieces) 	L5 Roof Border 5 (2 pieces) 	L6 Roof Border 6 (2 pieces) 	L7 Roof Border 7 (2 pieces) 	L8 Roof Border 8 (2 pieces) 
P0090003701	P0090003801	P0090003901	P0090004001	P0090004101	P0090004201
M1 Connector 1 (4 pieces) 	M3 Connector 3 (4 pieces) 	M5 Connector 5 (16 pieces) 	M6 Connector 6 (4 pieces) 	M8 Connector 8 (1 piece) 	M9 Connector 9 (4 pieces) 
P0060001401	P0060001701	P0060000602	P0110000701	P0060000702	P0110000502
N1 Roof Rib Cover 1 (4 pieces) 	N3 Roof Rib Cover 3 (4 pieces) 	N4 Roof Rib Cover 4 (1 piece) 	P6 Roof Plate 6 (2 pieces) 	P7 Roof Plate 7 (4 pieces) 	P8 Roof Plate 8 (4 pieces) 
P0120000102	P0120001201	P0120001401	P0130000102	P0130002001	P0130000202

ASSEMBLY INSTRUCTIONS

•Please carefully unpack each of the components and hardware. check the components against the parts list and make sure there are no missing parts. lay pieces on cardboard or a soft mat to help protect the pieces from scratches.

⚠ CAUTION

Watch for sharp edges when handling the pieces, wear gloves to avoid injury.

STEP 01 Slide foot base **B** and foot cover **C** onto post **A1**. Use four (4) **[AA]** bolts to attach foot base **B** to post **A1**. Repeat with the other three (3) posts **A1**.

[AA] x 16

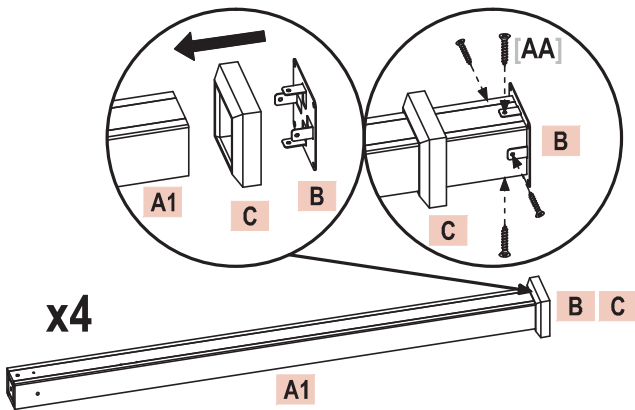

- For ease of assembly, it is recommended to have 3 or more people and allow enough time to completely finish the assembly. assembly can take 6-8 hours. a step-ladder is required for assembly (not included).
- Follow step by step instructions, and follow all safety warnings provided with your tools.
- DO NOT tighten screws until all the screws and washers are properly installed. tighten screws securely, do not over tighten.
- Gazebo should not be used in inclement weather and high winds.

STEP 02 Attach four (4) **[JJ]** screw nuts to each end of cross beam **D2**. Use four (4) **[FF]** bolts and four (4) **[LL]** flat washers to attach cross beam **D1** to connector **M1** and cross beam **D2**. Repeat with the other assembly. Attach four (4) **[JJ]** screw nuts to each end of cross beam **D4**. Use four (4) **[FF]** bolts and four (4) **[LL]** flat washers to attach cross beam **D3** to connector **M1** and cross beam **D4**. Repeat with the other assembly.

[FF] x 16
[LL] x 16
[JJ] x 16

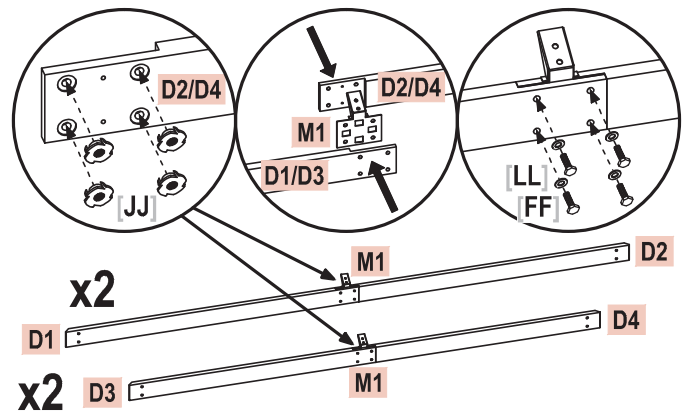

STEP 03 Use ten (10) **[AA]** bolts to attach one (1) connector **M6** to cross beam assembly **D1 D2** and **D3 D4**. Repeat with the other cross beam assembly **D1 D2** and **D3 D4**.

[AA] x 40

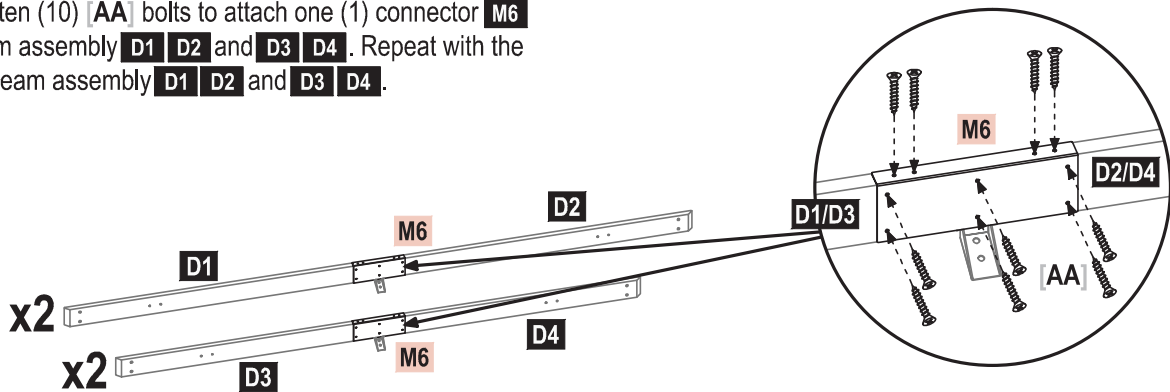

STEP 04 Attach the cross beam assembly **D1 D2** to left **A1** post using one (1) **[CC]** bolt and **[MM]** washer in the top hole, and one (1) **[GG]** bolt, two (2) **[MM]** washers, and one (1) **[HH]** nut in the bottom hole. Attach the cross beam assembly to right **A1** post using one (1) **[GG]** bolt, two (2) **[MM]** washers, and one (1) **[HH]** nut in the top hole, and one (1) **[CC]** bolt and **[MM]** washer in the bottom hole. Repeat to make a second assembly.

- [CC]** x 4
- [GG]** x 4
- [HH]** x 4
- [MM]** x 12

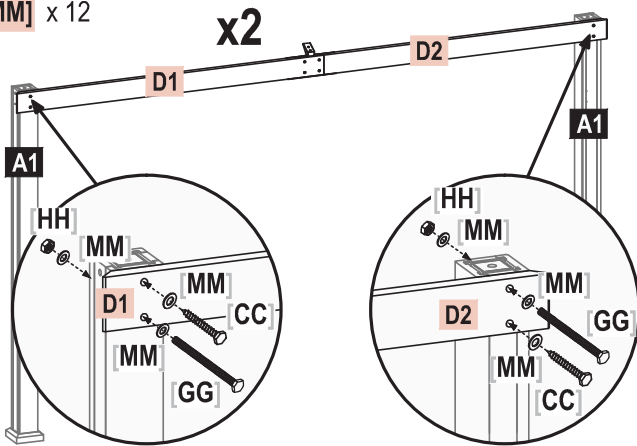

STEP 05 Attach the cross beam assembly **D3 D4** to left **A1** post using one (1) **[CC]** bolt and **[MM]** washer in the top hole, and one (1) **[GG]** bolt, two (2) **[MM]** washers, and one (1) **[HH]** nut in the bottom hole. Attach the cross beam assembly to right **A1** post using one (1) **[GG]** bolt, two (2) **[MM]** washers, and one (1) **[HH]** nut in the top hole, and one (1) **[CC]** bolt and **[MM]** washer in the bottom hole. Repeat to make a second assembly.

- [CC]** x 4
- [GG]** x 4
- [HH]** x 4
- [MM]** x 12

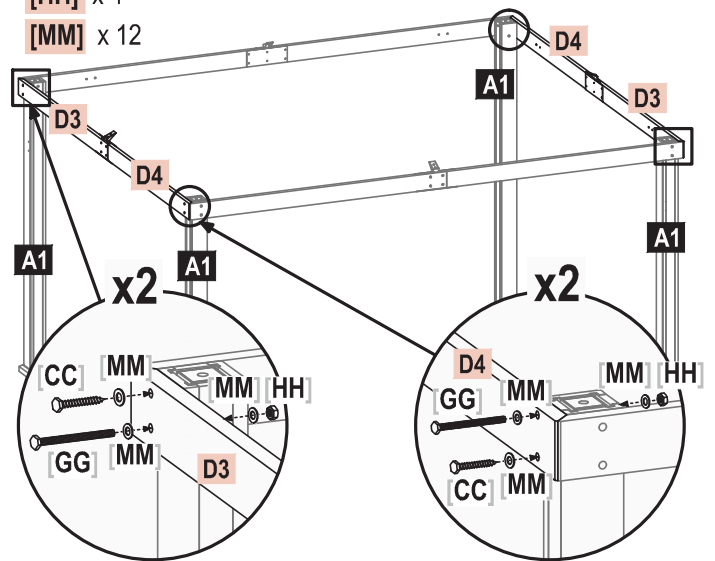

STEP 06

CRITICAL: SQUARE UNIT BEFORE PROCEEDING TO NEXT STEPS. ONCE SQUARE, TIGHTEN ALL HARDWARE.

