



**INSTRUCTIONS D'ASSEMBLAGE  
ASSEMBLY INSTRUCTIONS**

---

**TABLES GIGOGNES -  
ENS. 2PCS / BLANC LUSTRE / CHROME**

**NESTING TABLE -  
2PCS SET / GLOSSY WHITE / CHROME METAL**

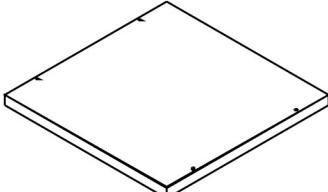
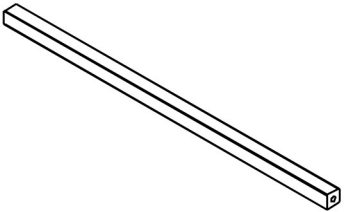
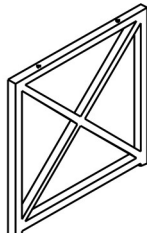
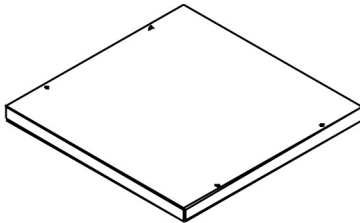
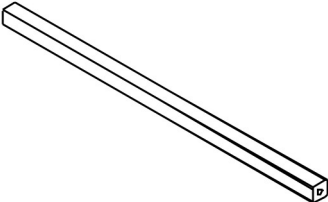

## LISTE DES PIÈCES PARTS LIST

PIÈCE / PART #	IMAGE	DESCRIPTION	QTY / QTÉ
<b>1</b>		<b>TABLE TOP (LARGE) DESSUS DE TABLE (GRAND)</b>	<b>1</b>
<b>2</b>		<b>CROSSBAR (LONG) BARRE TRANSVERSALE (LONGUE)</b>	<b>1</b>
<b>3</b>		<b>LEG FOR LARGE TABLE PATTE POUR GRANDE TABLE</b>	<b>2</b>
<b>4</b>		<b>TABLE TOP (SMALL) DESSUS DE TABLE (PETIT)</b>	<b>1</b>
<b>5</b>		<b>CROSSBAR (SHORT) BARRE TRANSVERSALE (COURTE)</b>	<b>1</b>

**LISTE DES PIÈCES**  
**PARTS LIST**

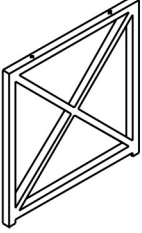
PIÈCE / PART #	IMAGE	DESCRIPTION	QTY / QTÉ
6		LEG FOR SMALL TABLE PATTE POUR PETITE TABLE	2

## LISTE DES PIÈCES DE MONTAGE HARDWARE LIST

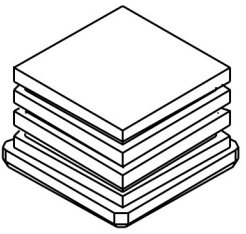
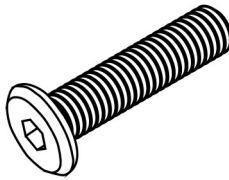
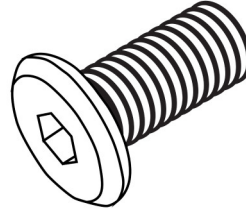
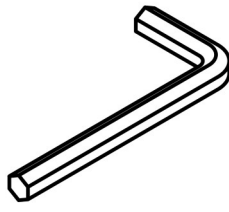
PIÈCE / PART #	IMAGE	DESCRIPTION	QTY / QTÉ
<b>A</b>		<b>FLOOR PROTECTOR - 3/4" X 3/4"</b>  <b>PROTECTEUR DE PLANCHER - 3/4" X 3/4"</b>	<b>8</b>
<b>B</b>		<b>ASSEMBLING BOLT - Ø1/4" X 1 1/2"</b>  <b>BOULON D'ASSEMBLAGE - Ø1/4" X 1 1/2"</b>	<b>4</b>
<b>C</b>		<b>ASSEMBLING BOLT - Ø1/4" X 1 1/8"</b>  <b>BOULON D'ASSEMBLAGE - Ø1/4" X 1 1/8"</b>	<b>8</b>
<b>D</b>		<b>HEX KEY</b>  <b>CLÉ HEXAGONALE</b>	<b>1</b>

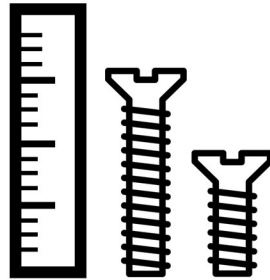

OUTIL DE VÉRIFICATION DE DIMENSIONS DES PIÈCES  
HARDWARE DIMENSIONS VERIFICATION TOOL

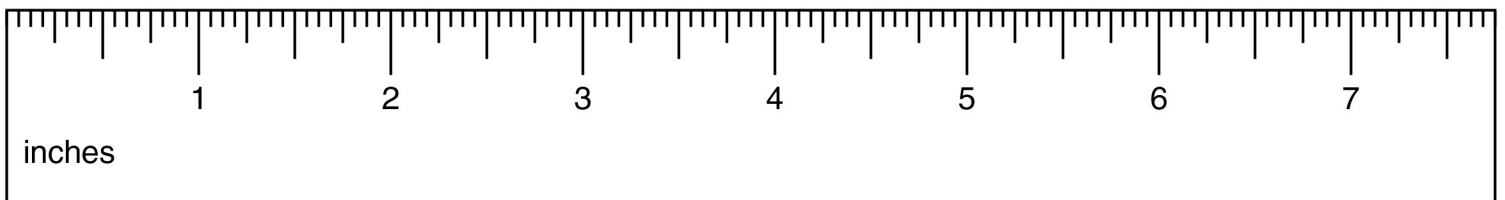

ÉTAPE / STEP 1

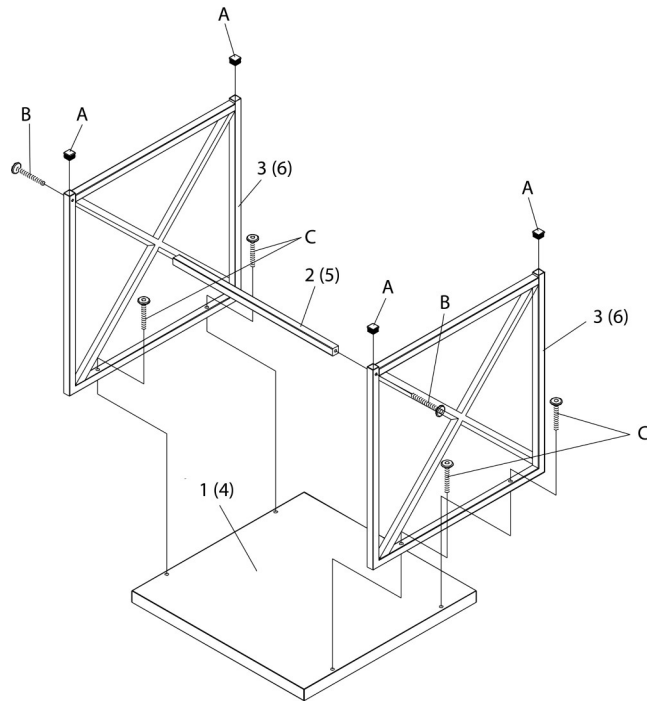

ÉTAPE / STEP 2

