

SKU:SF001017

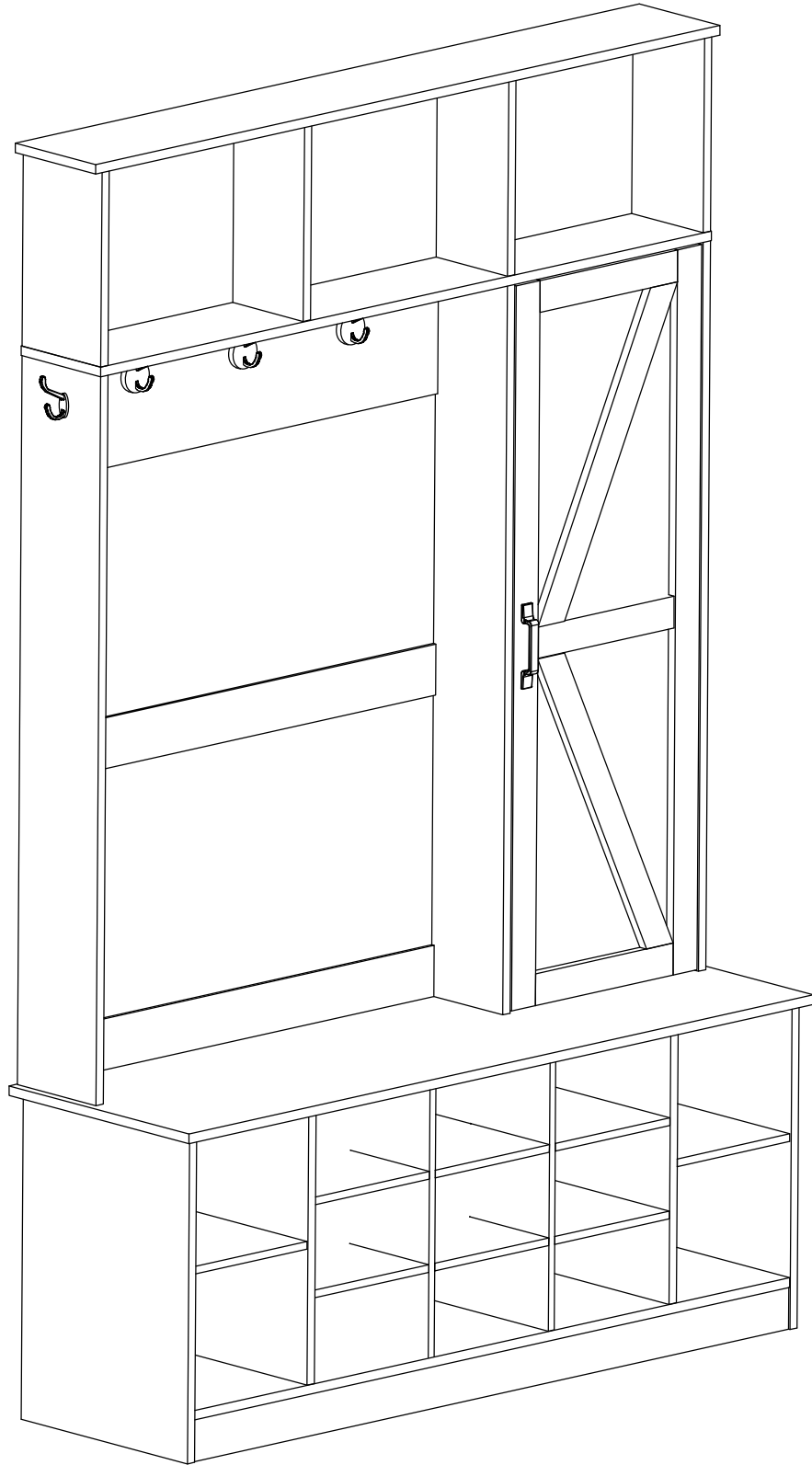

ASSEMBLY INSTRUCTIONS

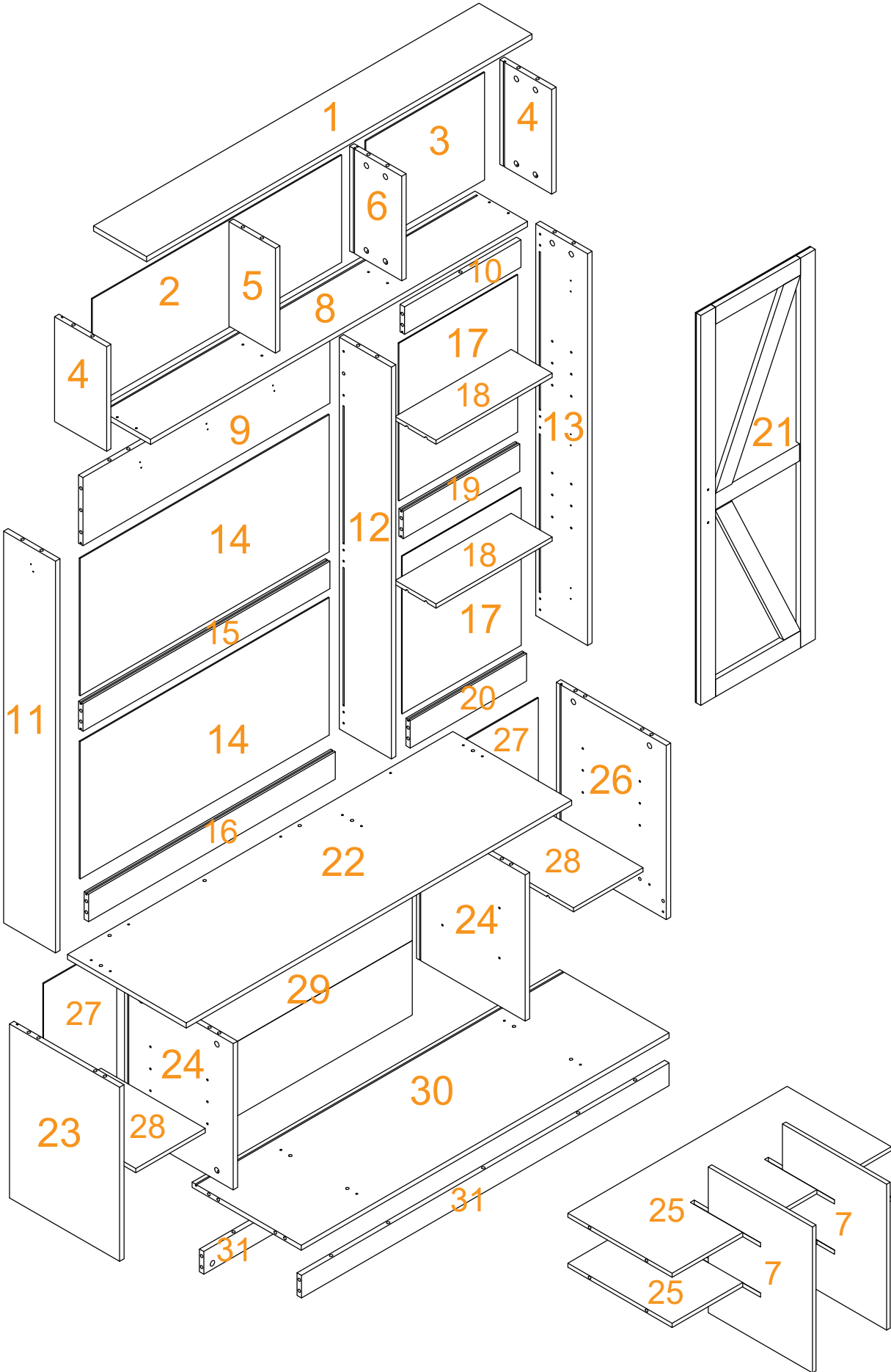

Trouble Shooting

Missing/Damaged pieces/
Wrong size and installation issues



Contact us with your problem, pic,
number and qty to the "Contact seller"
button in the detail page of your order



Respond with 24 hours to solve issue

Before You Start

1. Read through each step carefully and follow the proper order
2. Separate and count all your parts and hardware
3. Give yourself enough room for the assembly process
4. Caution: If using a power drill or power screwdriver for screwing, please be aware to slow down and stop when screw is tight. Failure to do so may result in stripping the screw

Cam Lock Fastening System

This Cam Lock Fastening System will be used throughout the assembly process

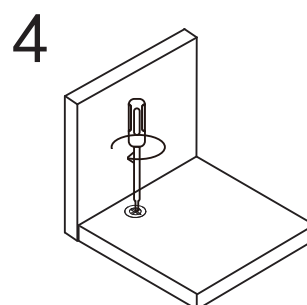
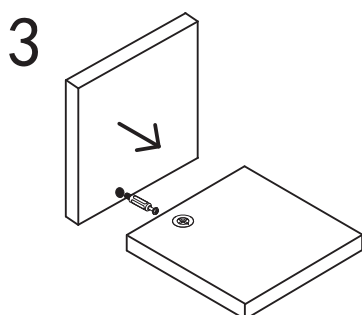
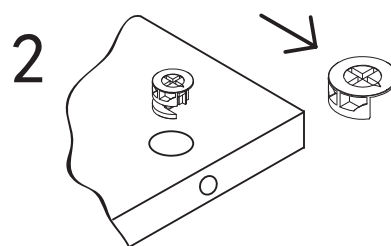

Parts List

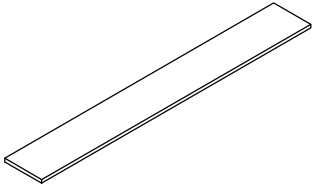

1 1PC

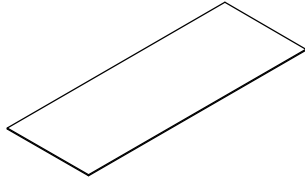

2 1PC

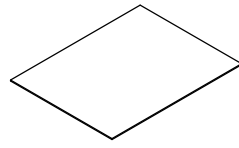

3 1PC

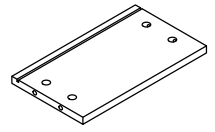

4 2PCS

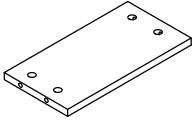

5 1PC

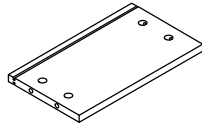

6 1PC

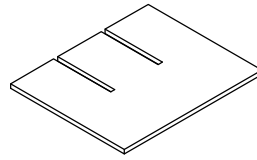

7 2PCS

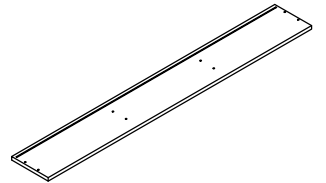

8 1PC

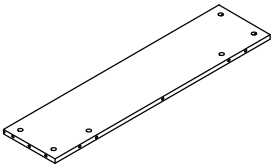

9 1PC

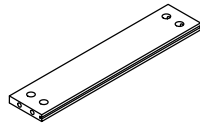

10 1PC

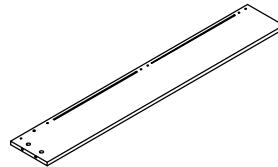

11 1PC

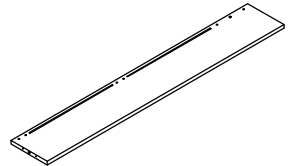

12 1PC

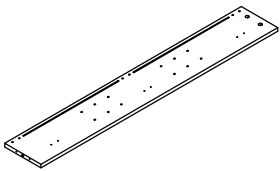

13 1PC

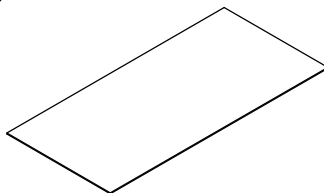

14 2PCS

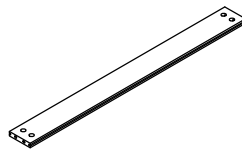

15 1PC

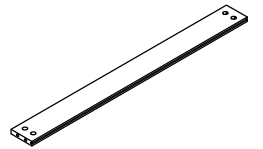

16 1PC

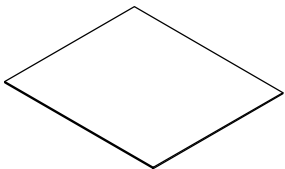

17 2PCS

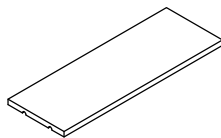

18 2PCS

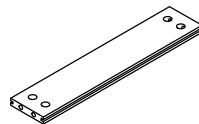

19 1PC

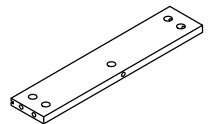

20 1PC

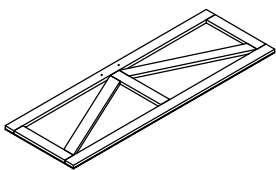

21 1PC

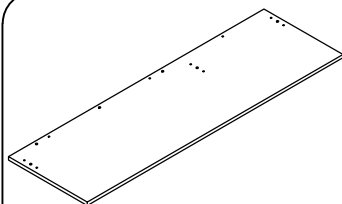

22 1PC

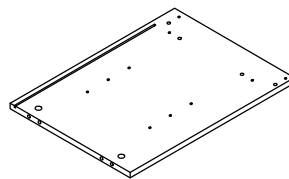

23 1PC

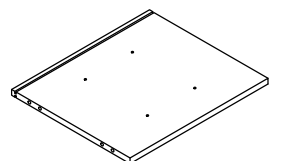

24 2PCS

Parts List

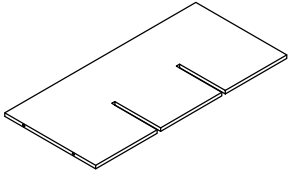

25 | 2PCS

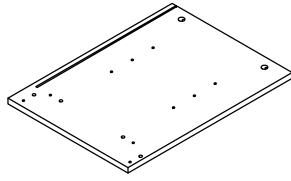

26 | 1PC

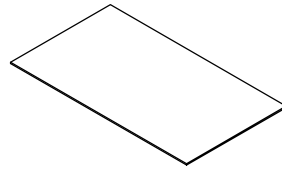

27 | 2PCS

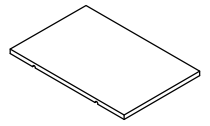

28 | 2PCS

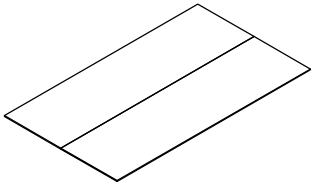

29 | 1PC

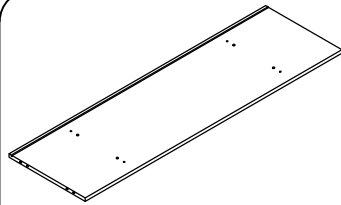

30 | 1PC

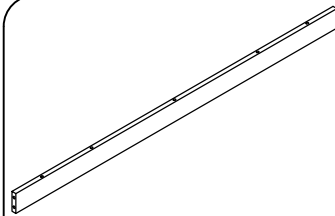

31 | 2PCS

Hardware List



A

81PCS

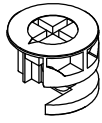

Ø15

B

81PCS



Ø8*30mm

C

37PCS

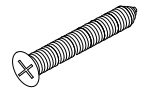

Ø4*40mm

D

9PCS

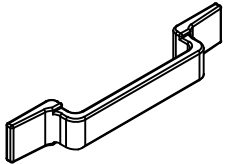

E

1PC



M4*22mm

F

2PCS



G

2PCS



Ø3*14MM

H

8PCS



I

16PCS

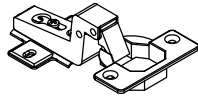

J

3PCS



Ø3.5*14mm

K

12PCS



L

1PC

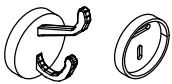

M

3PCS



N

2PCS



O

1PC



Ø4*14MM

P

6PCS

STEP 1

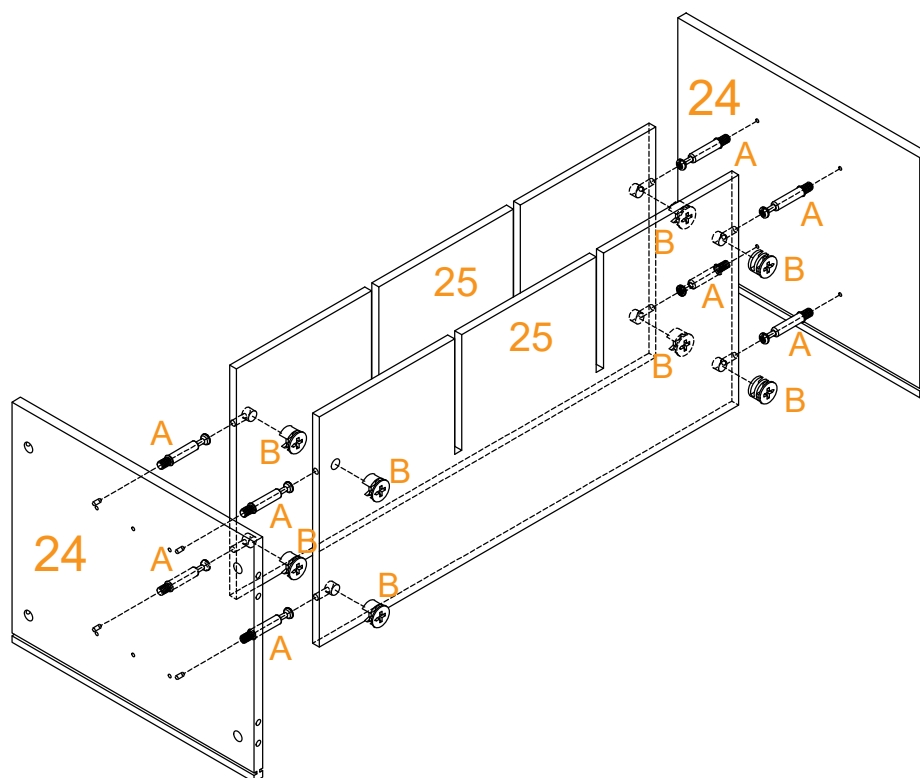
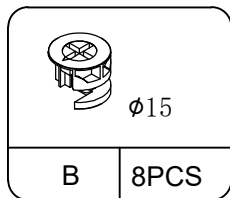
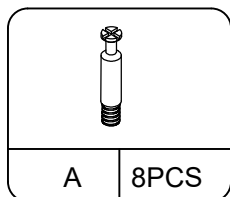

STEP 2

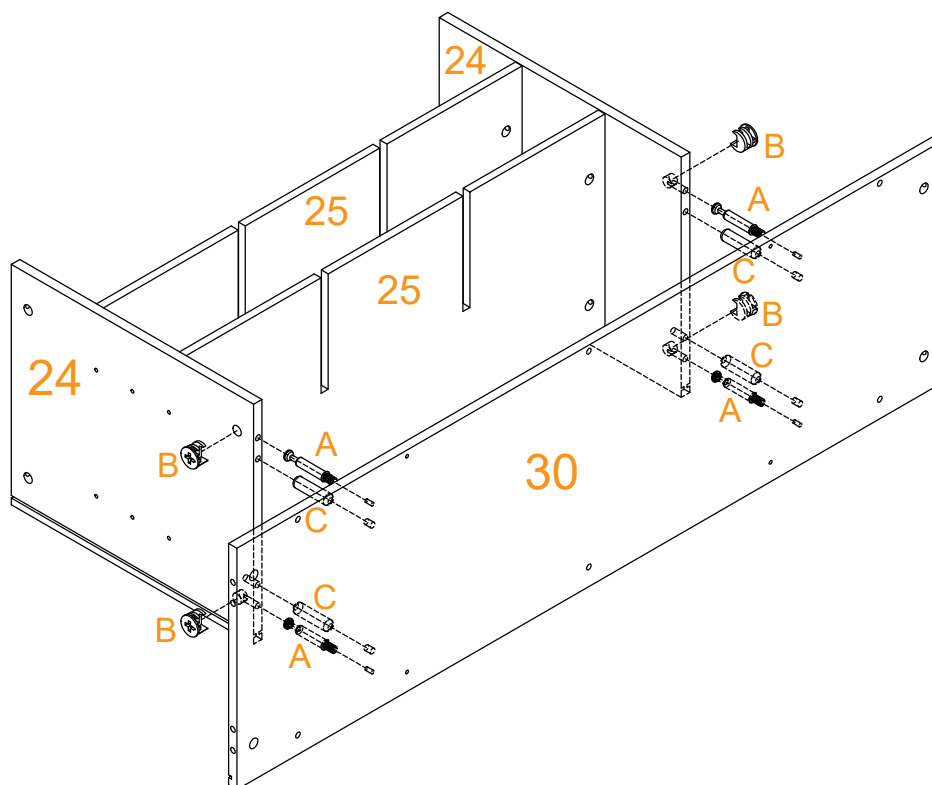
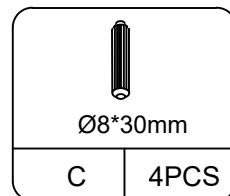
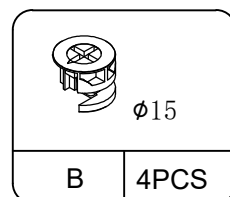
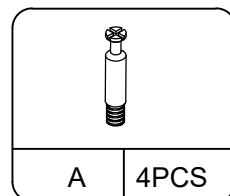

STEP 3

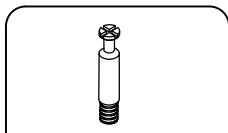

A 4PCS

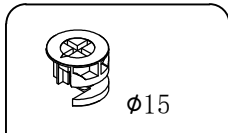

B 4PCS

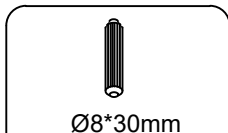

C 6PCS

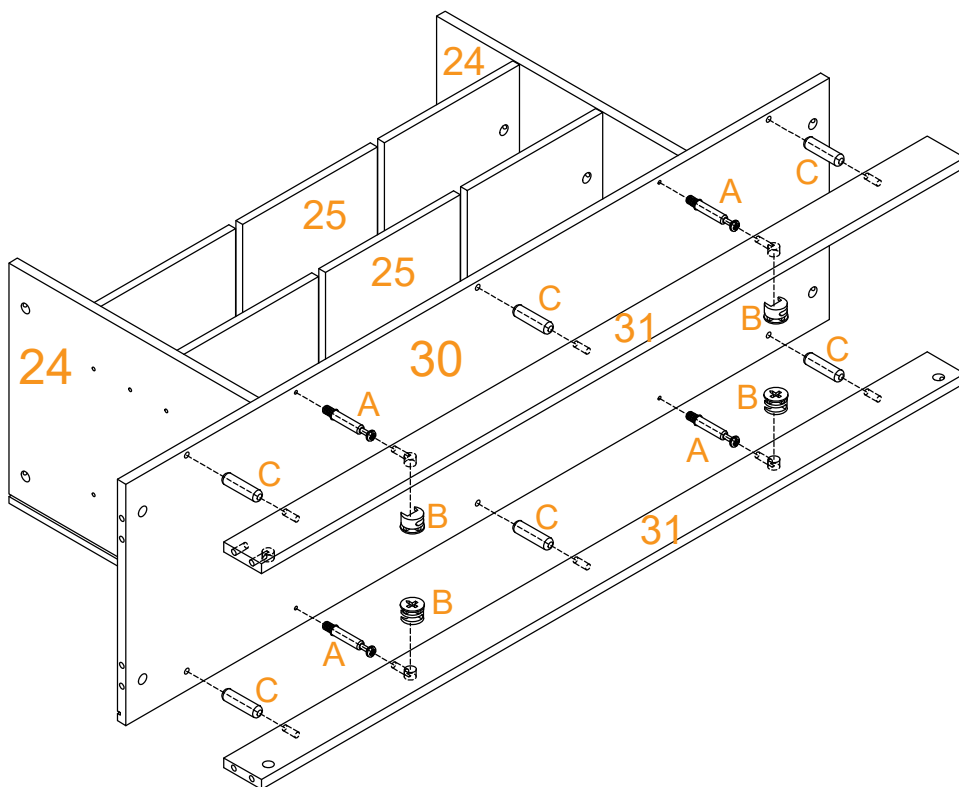

STEP 4

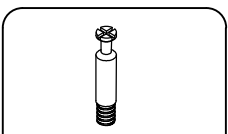

A 8PCS



B 8PCS

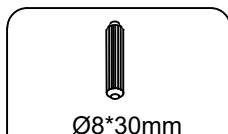

C 8PCS

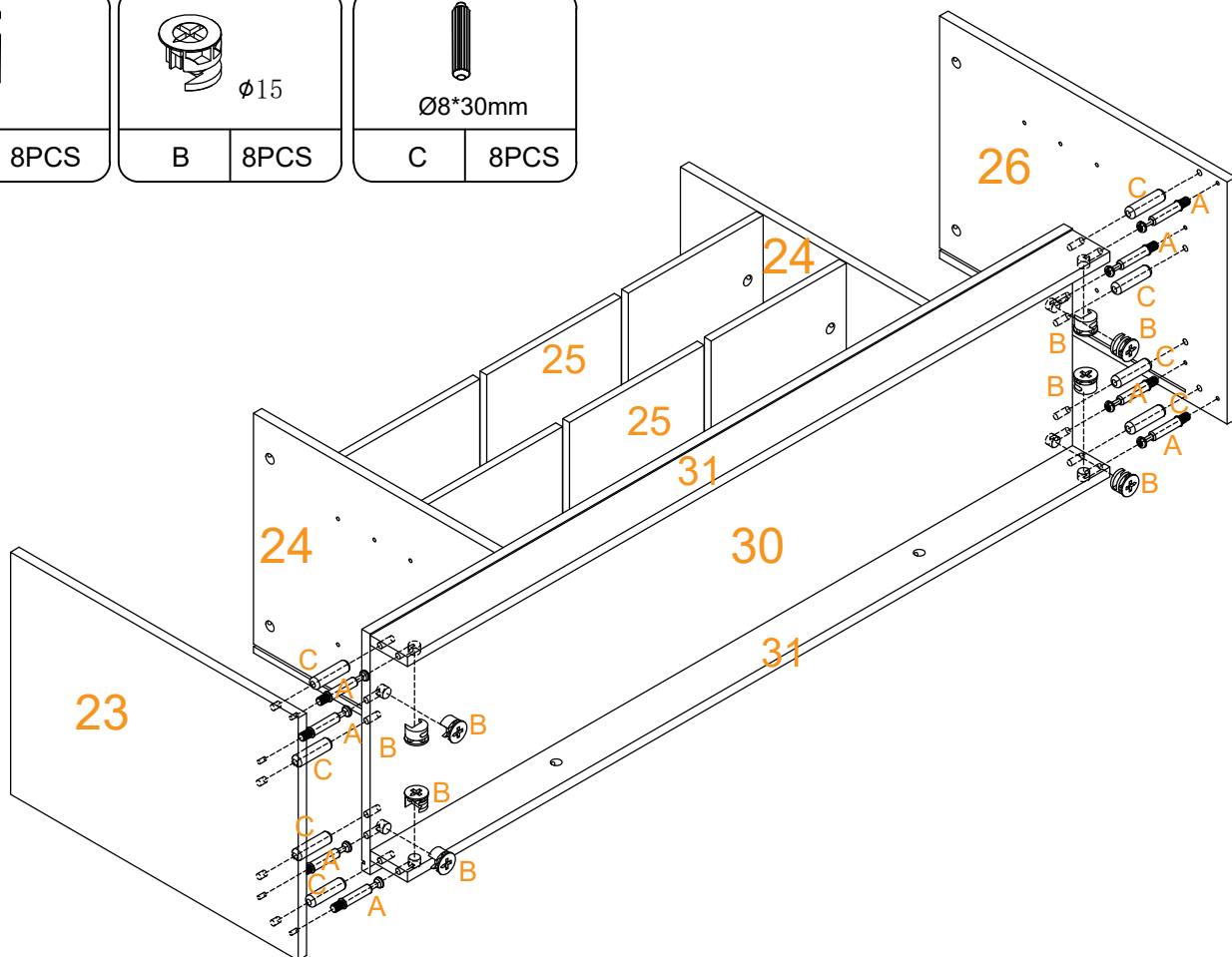

STEP 5

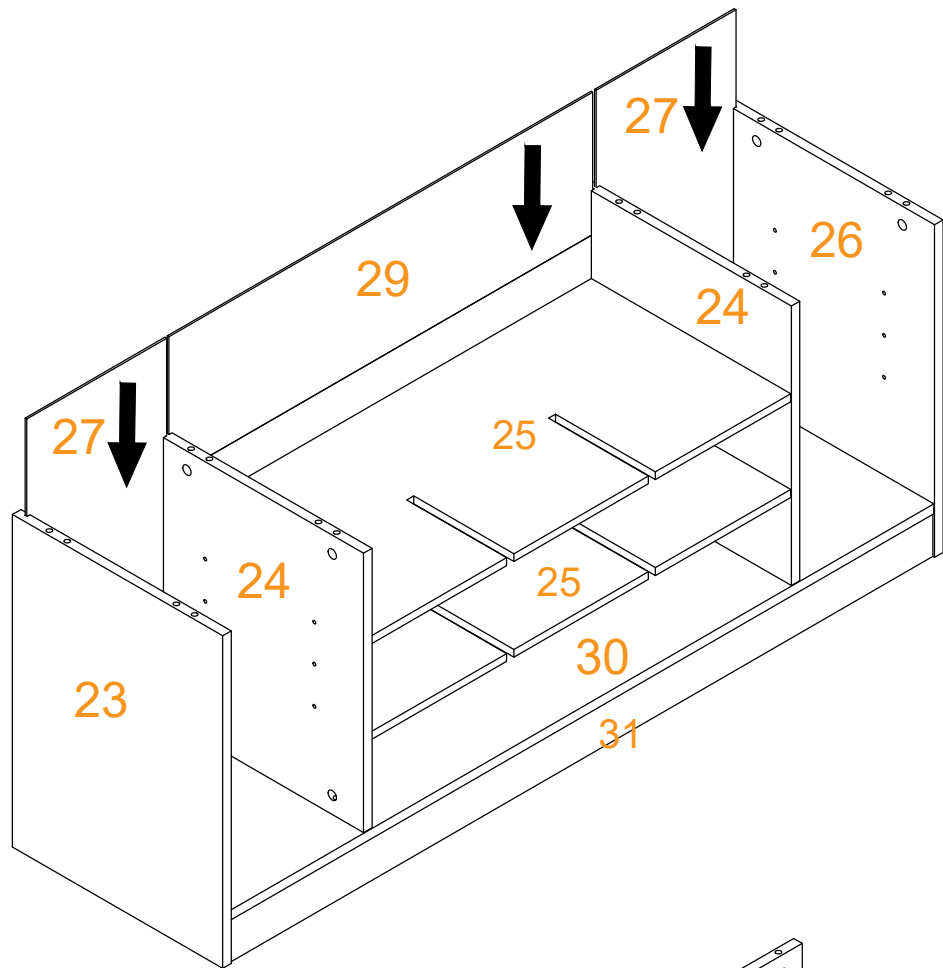

STEP 6

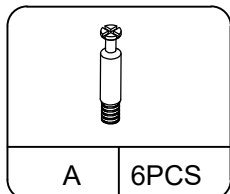

A 6PCS

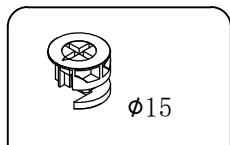

B 6PCS

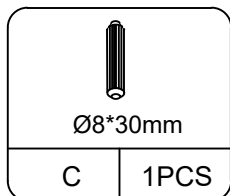

Ø8*30mm

C 1PCS

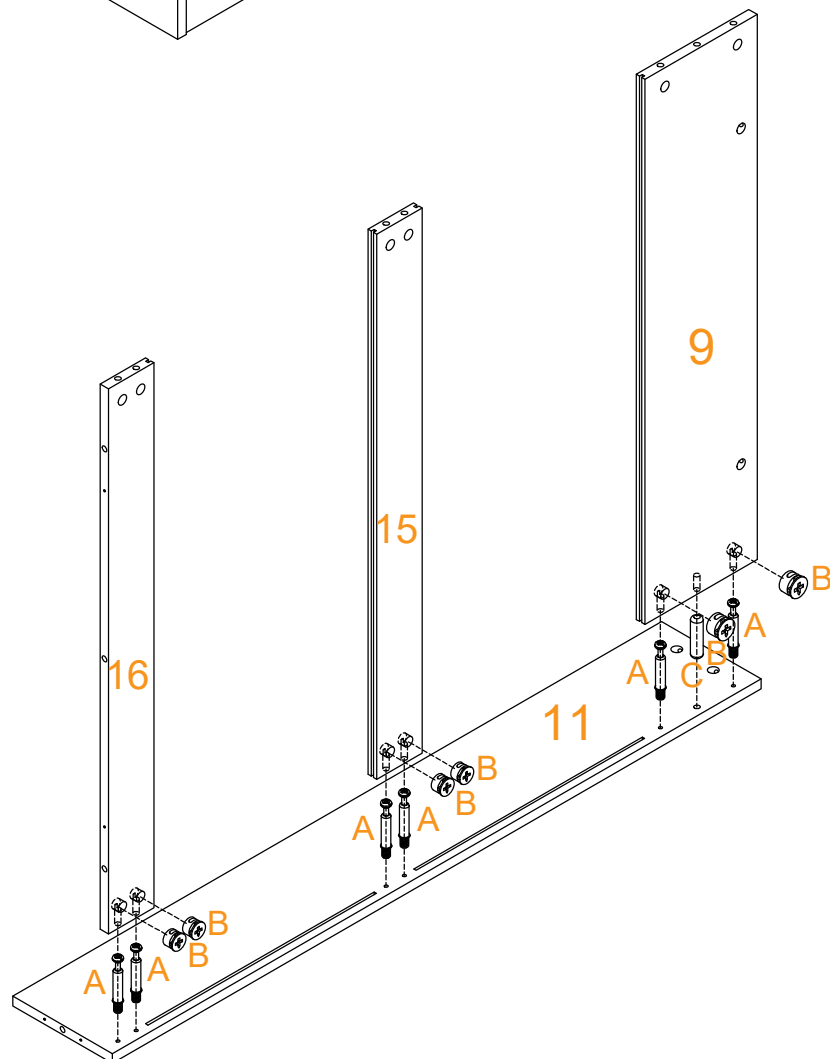

STEP 7



2

Important

2 people required
2 personnes requises
2 personas requeridas

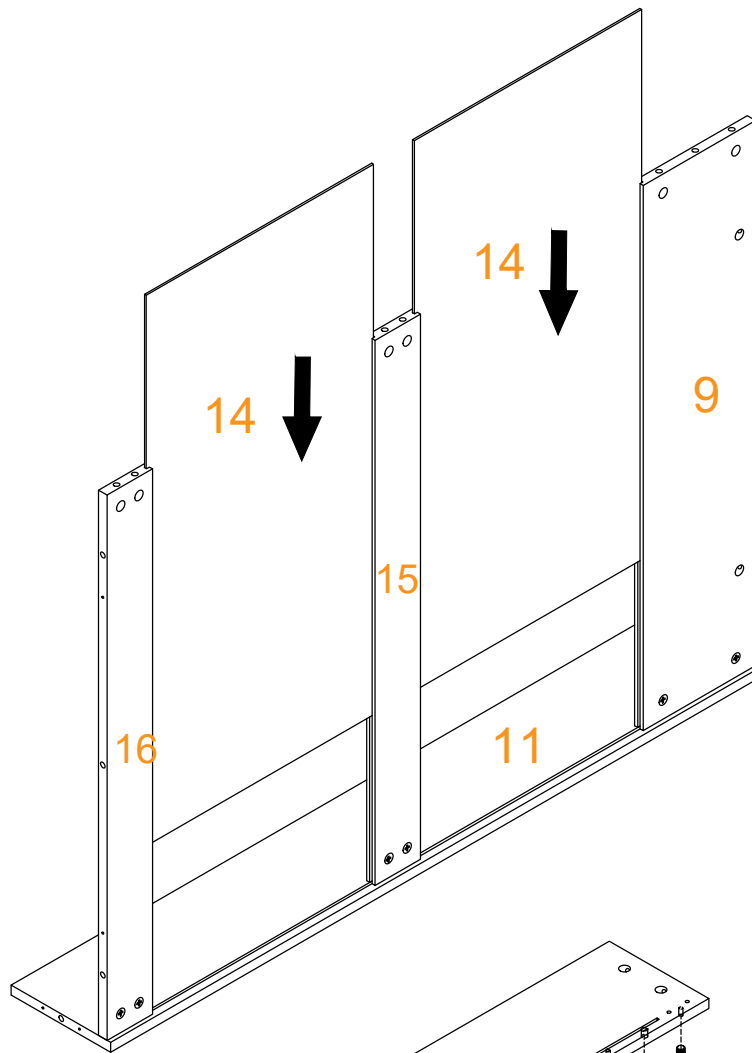

STEP 8

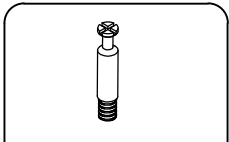

A

6PCS

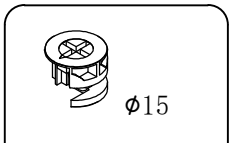

B

6PCS

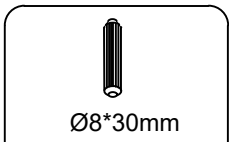

C

1PC

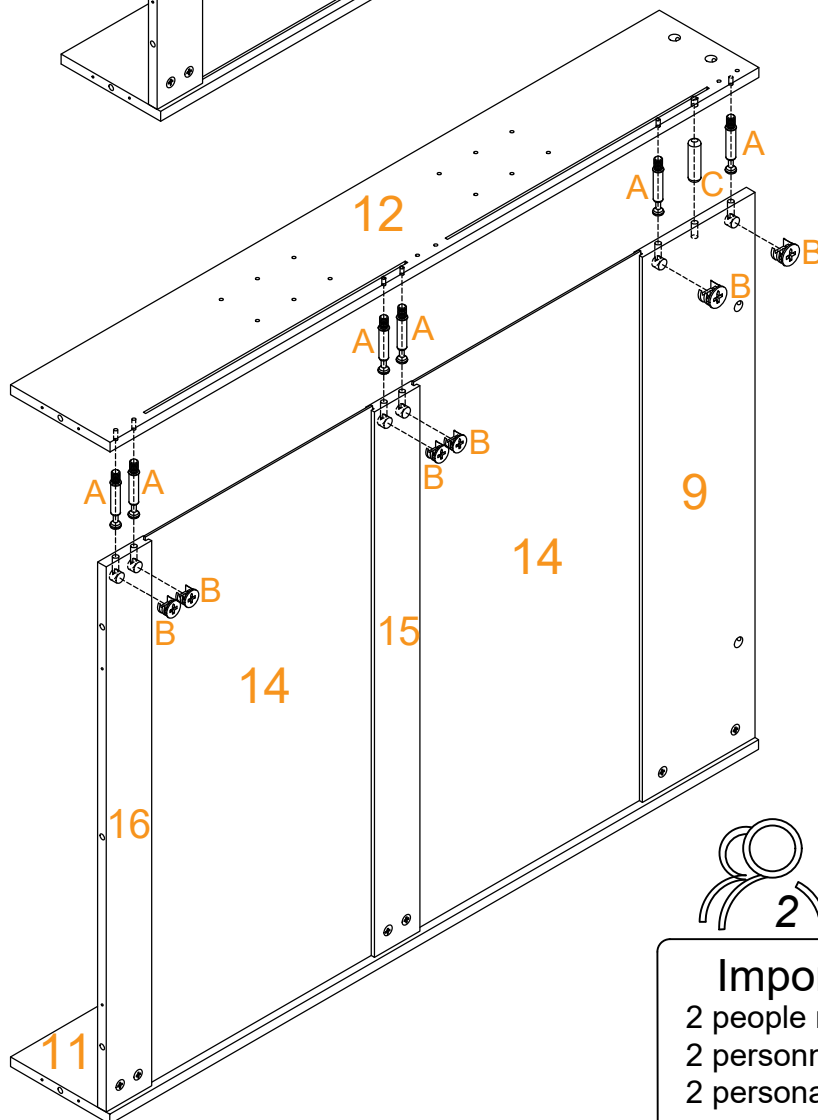

2

Important

2 people required
2 personnes requises
2 personas requeridas

STEP 9

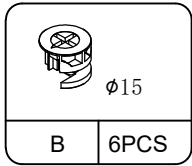
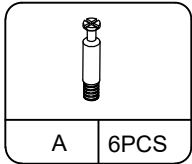

Important
 2 people required
 2 personnes requises
 2 personas requeridas

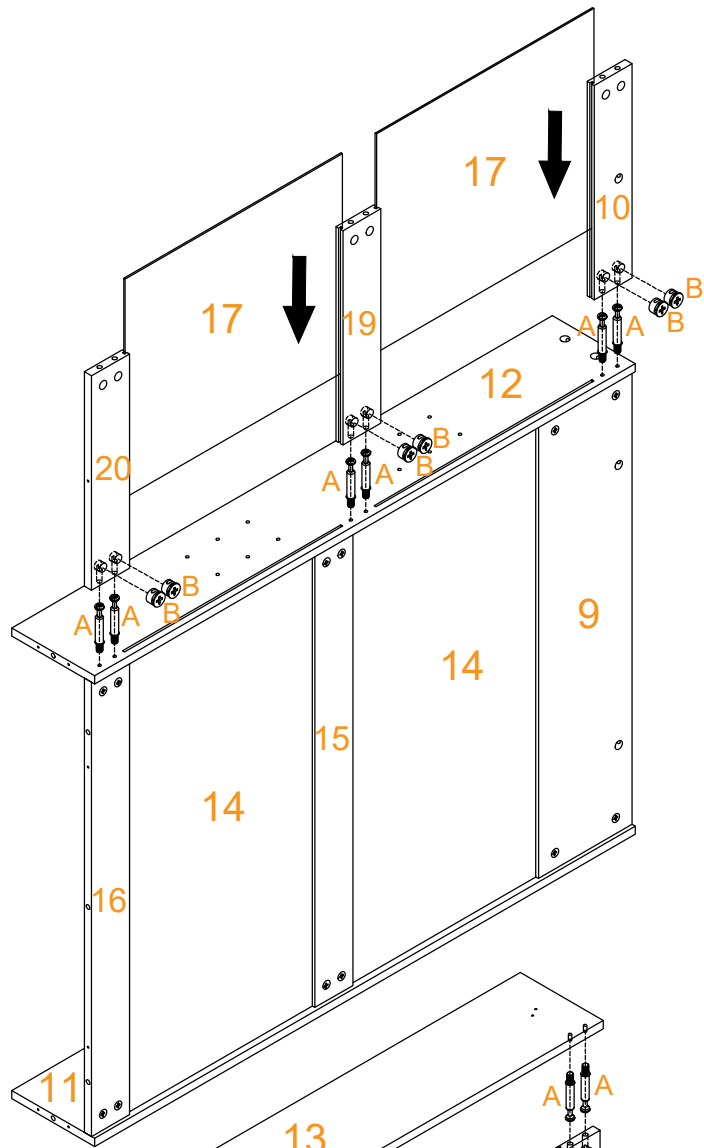

STEP 10

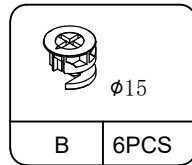
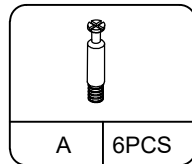

Important
 2 people required
 2 personnes requises
 2 personas requeridas

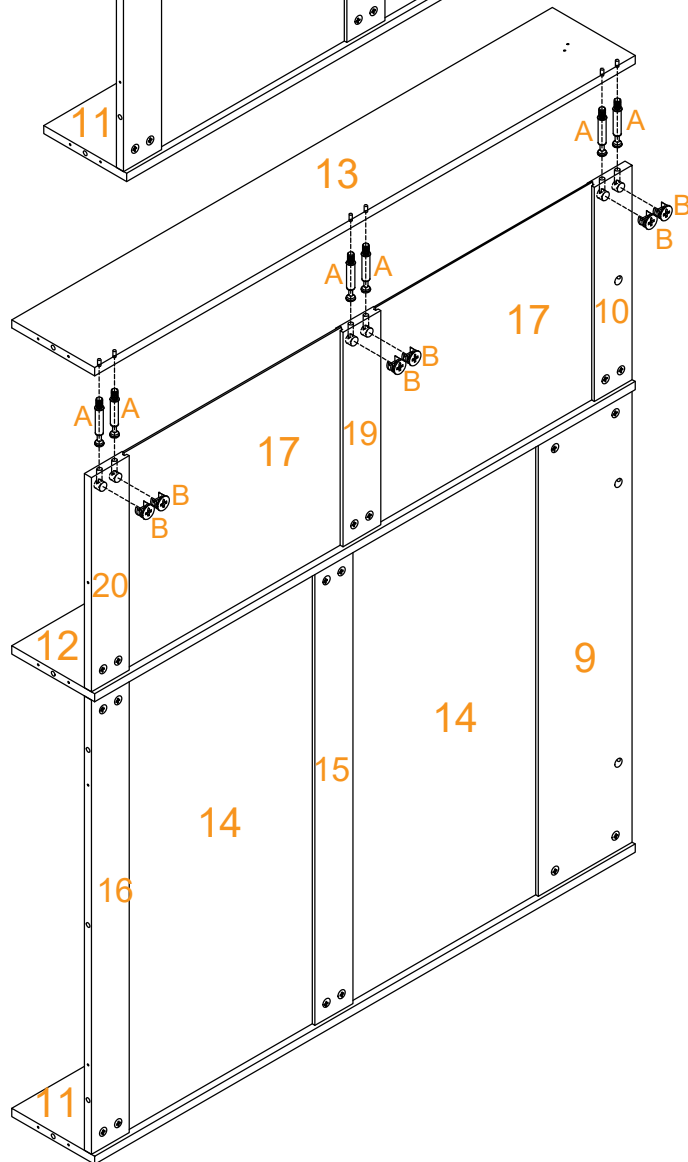

STEP 11

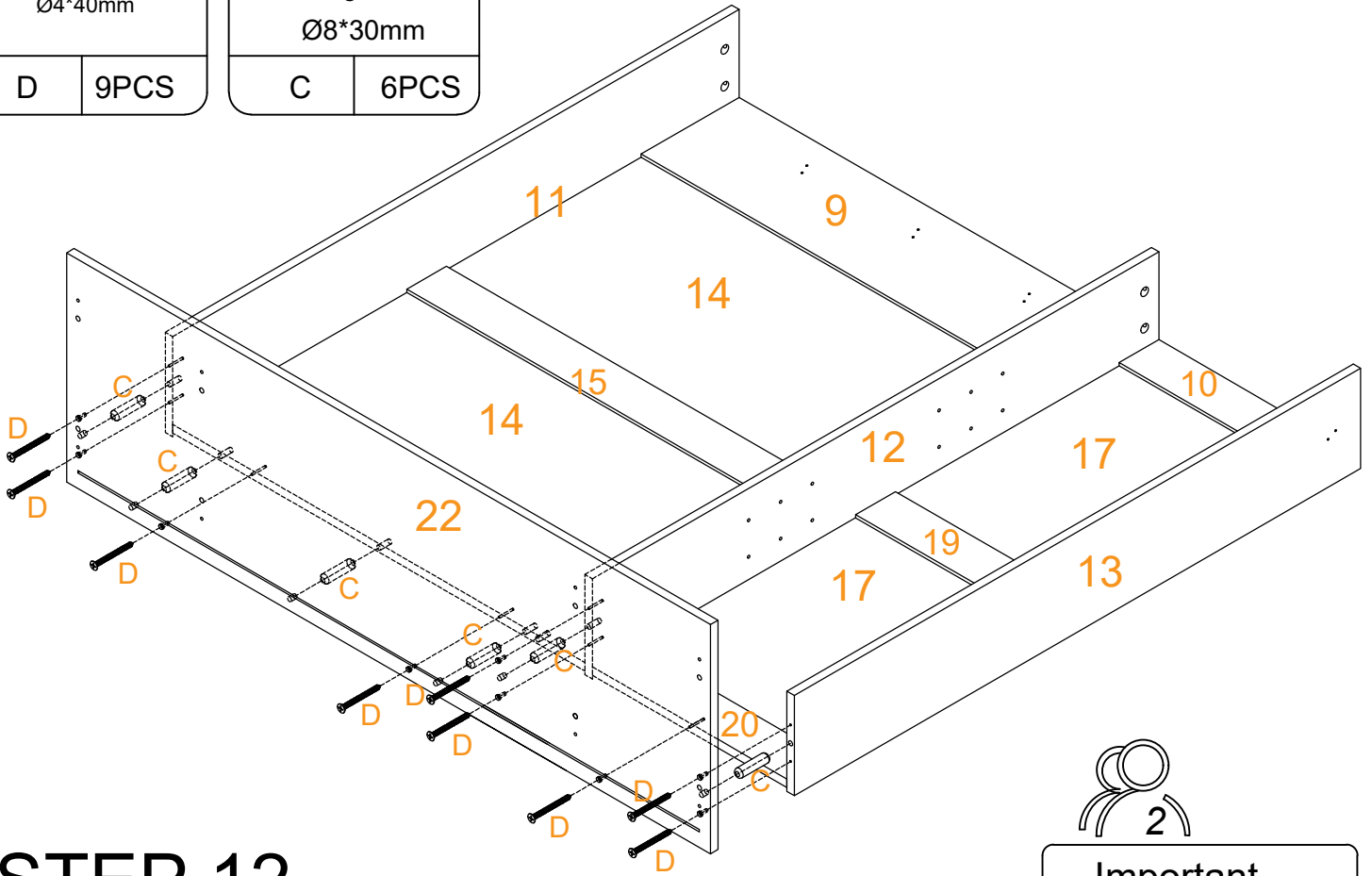
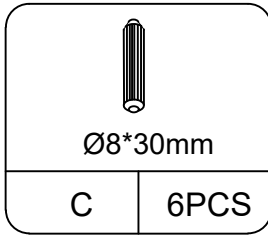
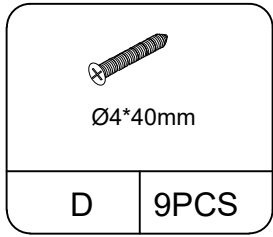

STEP 12

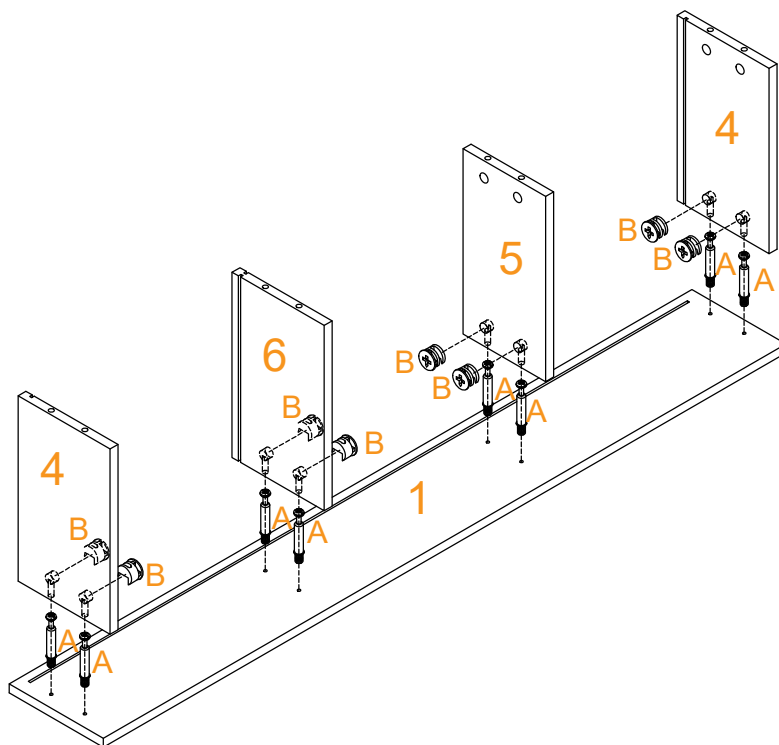
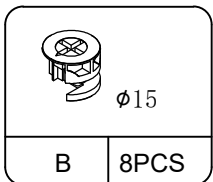
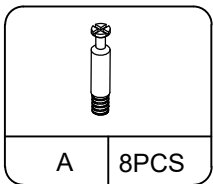

Important
 2 people required
 2 personnes requises
 2 personas requeridas

STEP 13

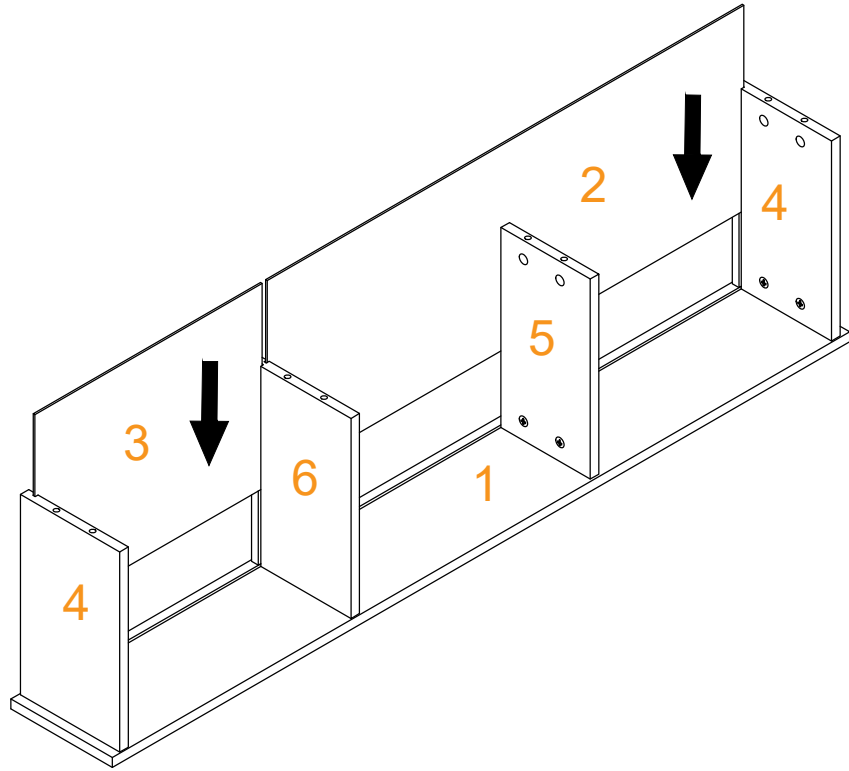

STEP 14

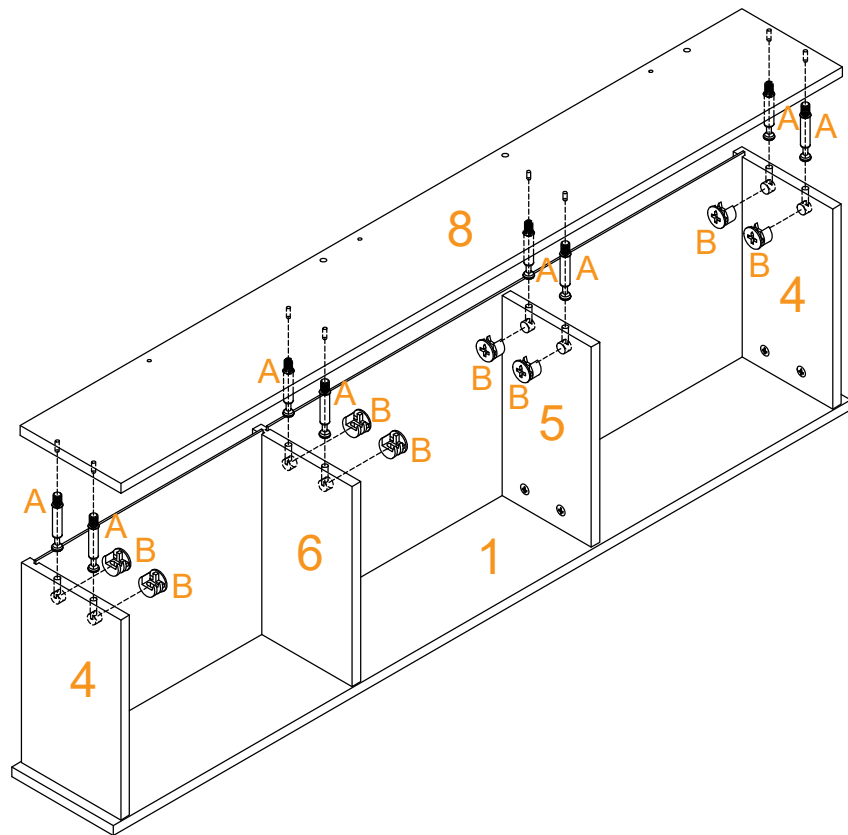
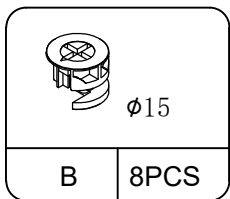
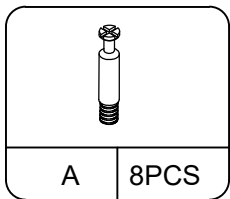

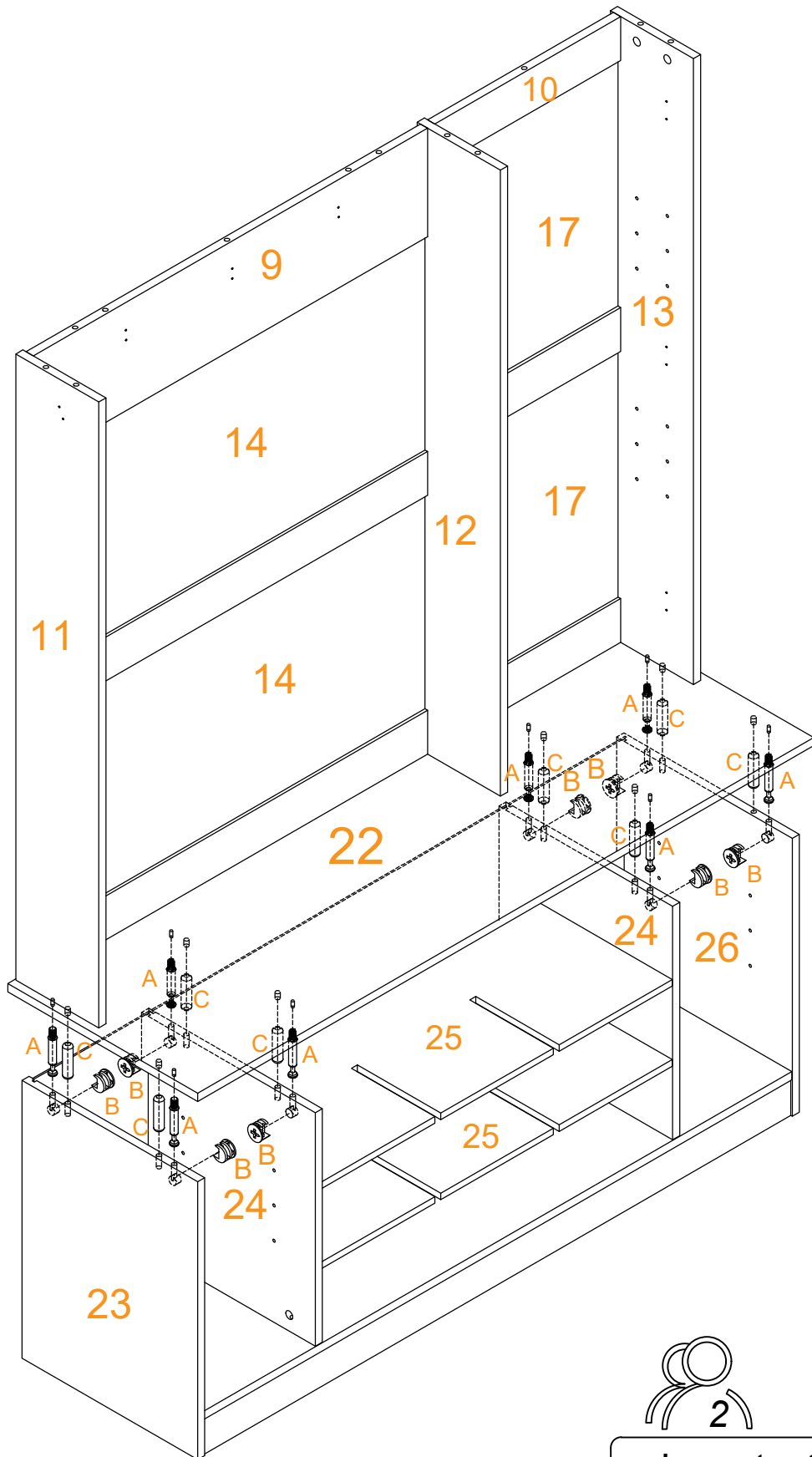
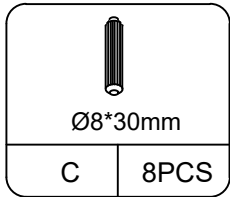
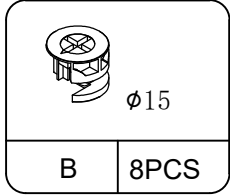
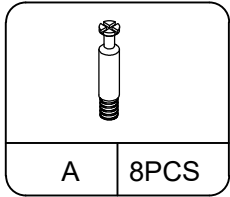

STEP 15





Important
2 people required
2 personnes requises
2 personas requeridas

STEP 16

| | |
|--|------|
|  Ø3*14MM | |
| H | 4PCS |

| | |
|---|-------|
|  | |
| I | 16PCS |

| | |
|---|------|
|  | |
| G | 2PCS |

| | |
|---|------|
|  | |
| M | 3PCS |

| | |
|---|-----|
|  | |
| O | 1PC |

| | |
|--|------|
|  Ø4*14MM | |
| P | 6PCS |

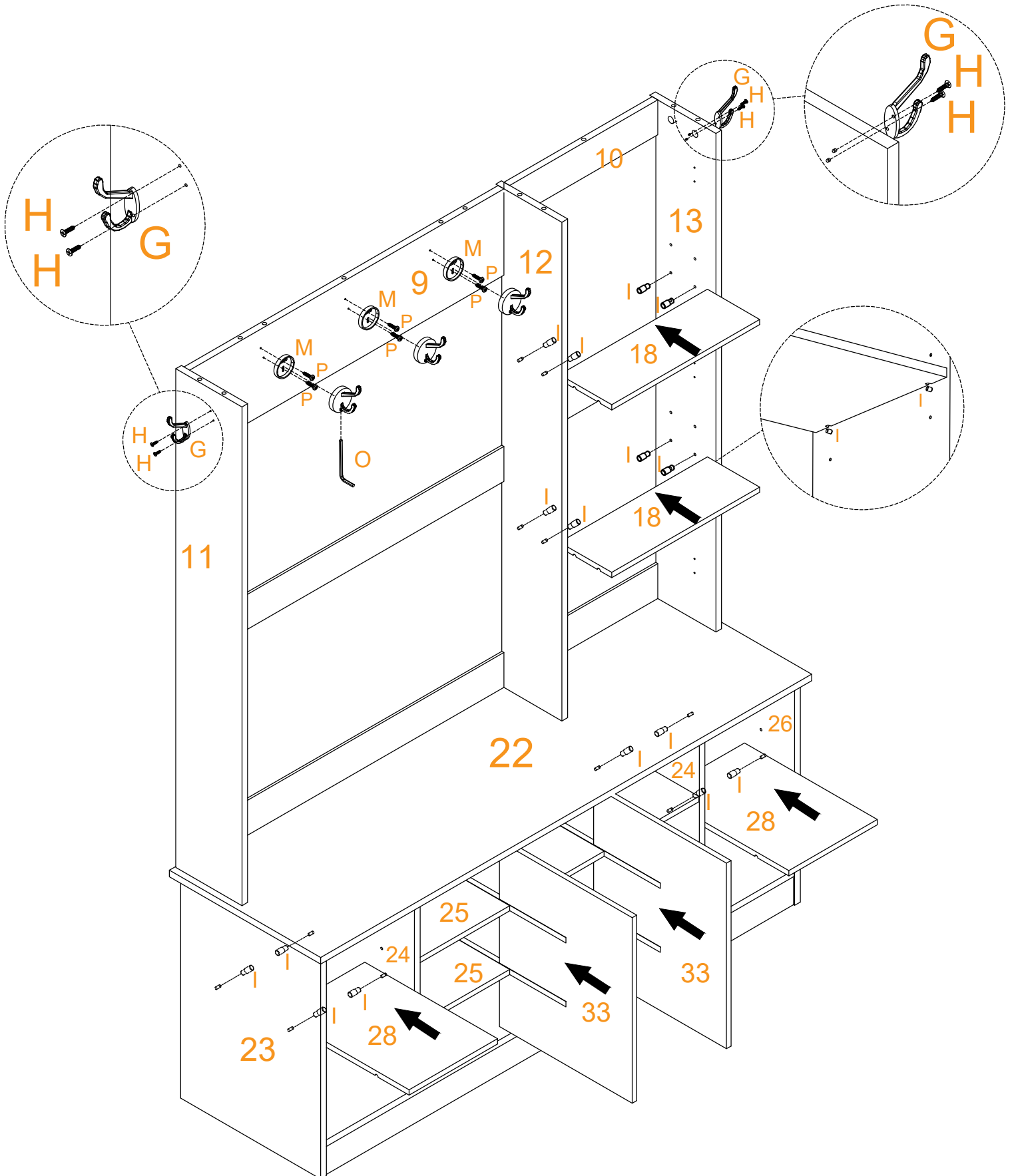

STEP 17

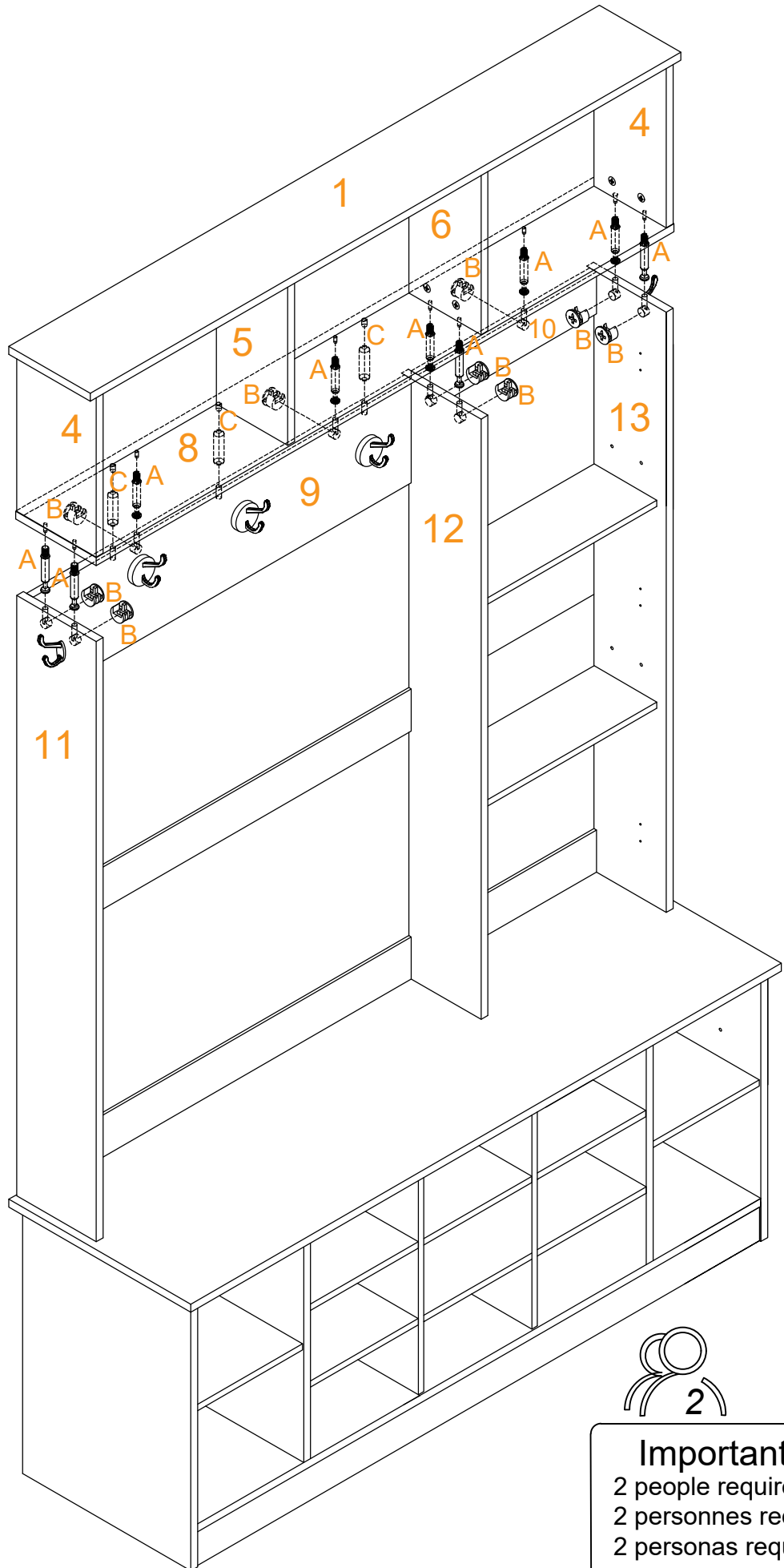
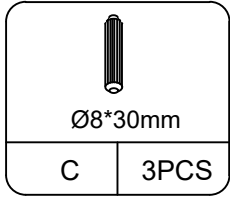
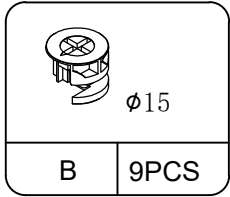
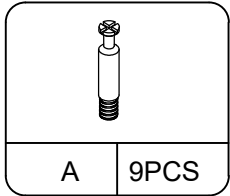

Important

2 people required
2 personnes requises
2 personas requeridas

STEP 18

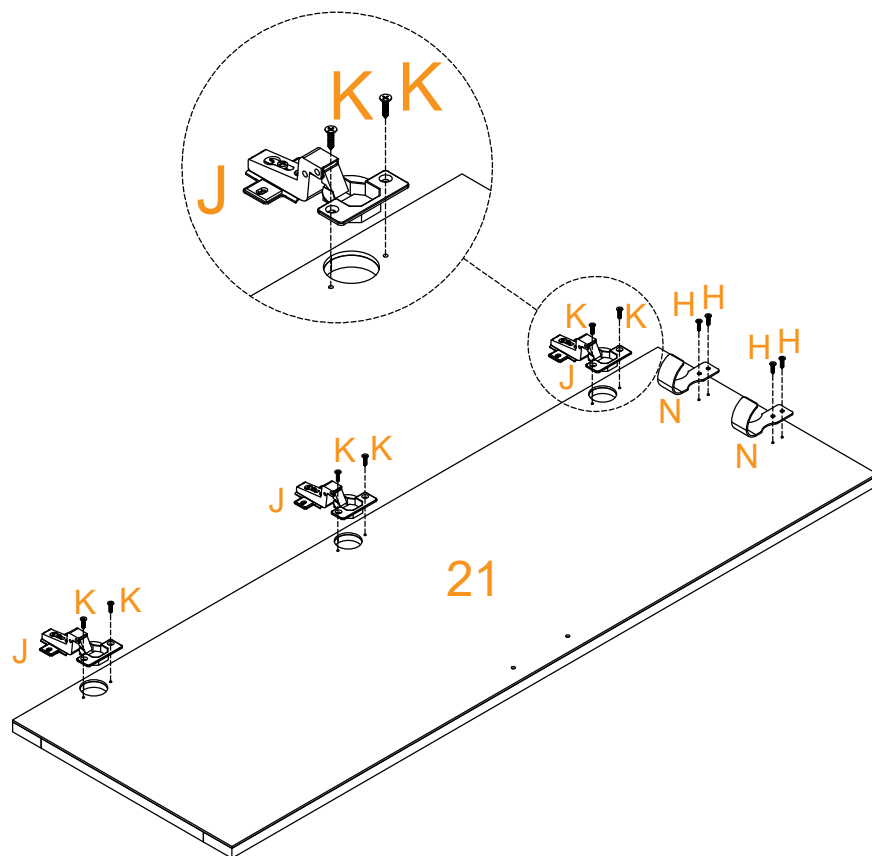
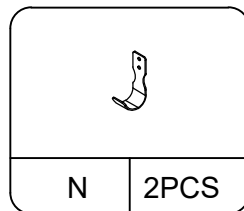
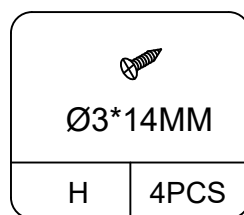
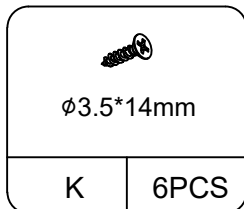
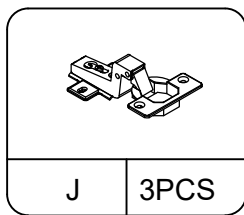

STEP 19

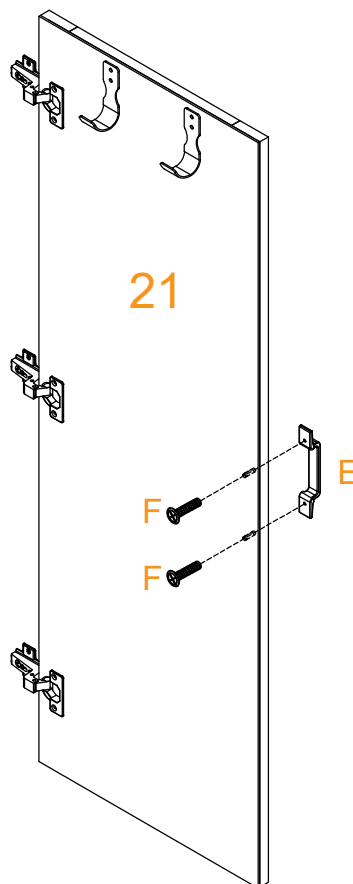
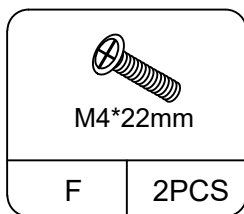
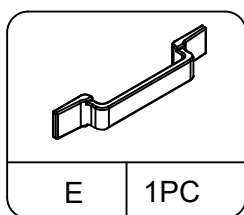

STEP 20



Ø3.5*14mm

K

6PCS

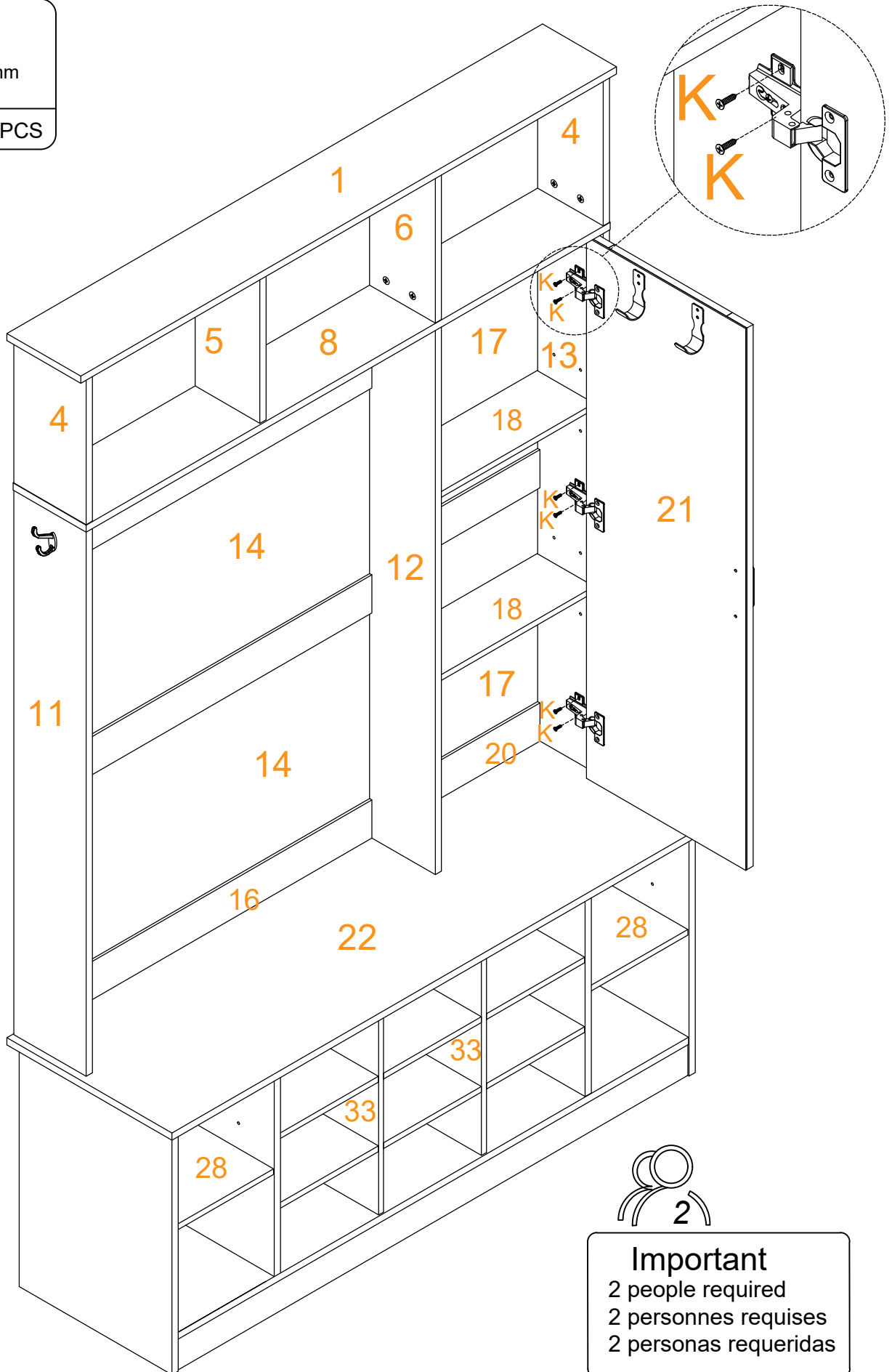

2

Important
2 people required
2 personnes requises
2 personas requeridas

STEP 21

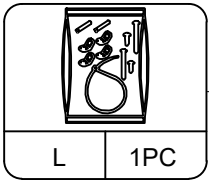

| PART LIST | FIGURE | QUANTITY | DESCRIPTION |
|-----------|--------|----------|--------------------------------|
| 1 | | 2PC | Long Screw (Dia.4mmX38mmL) |
| 2 | | 2PC | Short Screw (Dia.4mmX19mmL) |
| 3 | | 4PC | Metal L Bracket |
| 4 | | 2PC | Plastic Anchor |
| 5 | | 2PC | Cable |

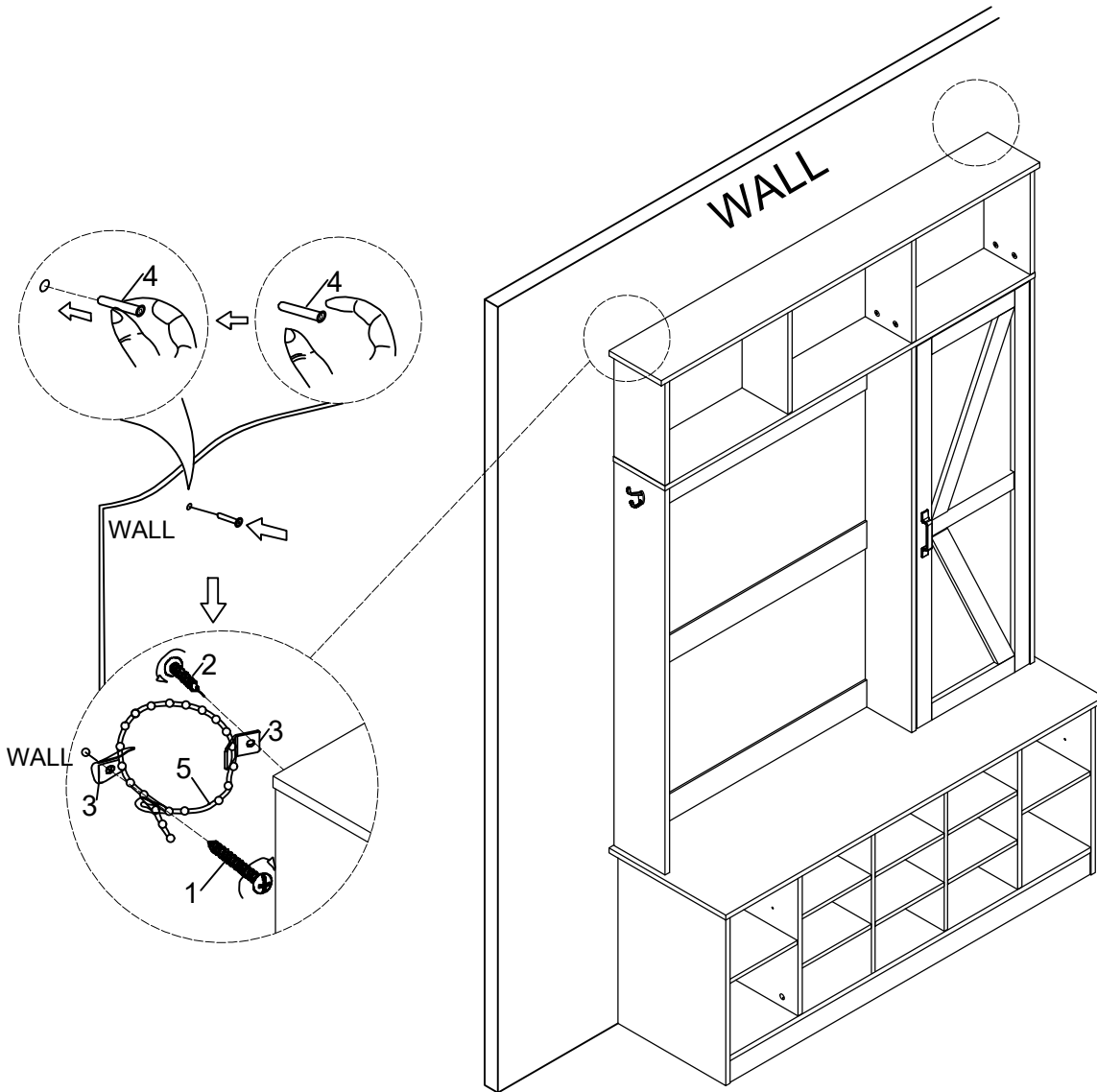

Follow the instructions printed on the plastic bag containing the tipping restraint hardware to attach the tip-over restraints to the unit and the wall.

NOTE: The tipping restraint hardware included is designed for drywall construction. You will need to drill holes for the wall anchors. Depending on your wall type, different anchor hardware may be required. Please contact your local hardware store for assistance.