

**TZSKHS-V1**

FTPLDB-0049  
FTPLDB-0050  
FTPLDB-0051  
FTPLDB-0052

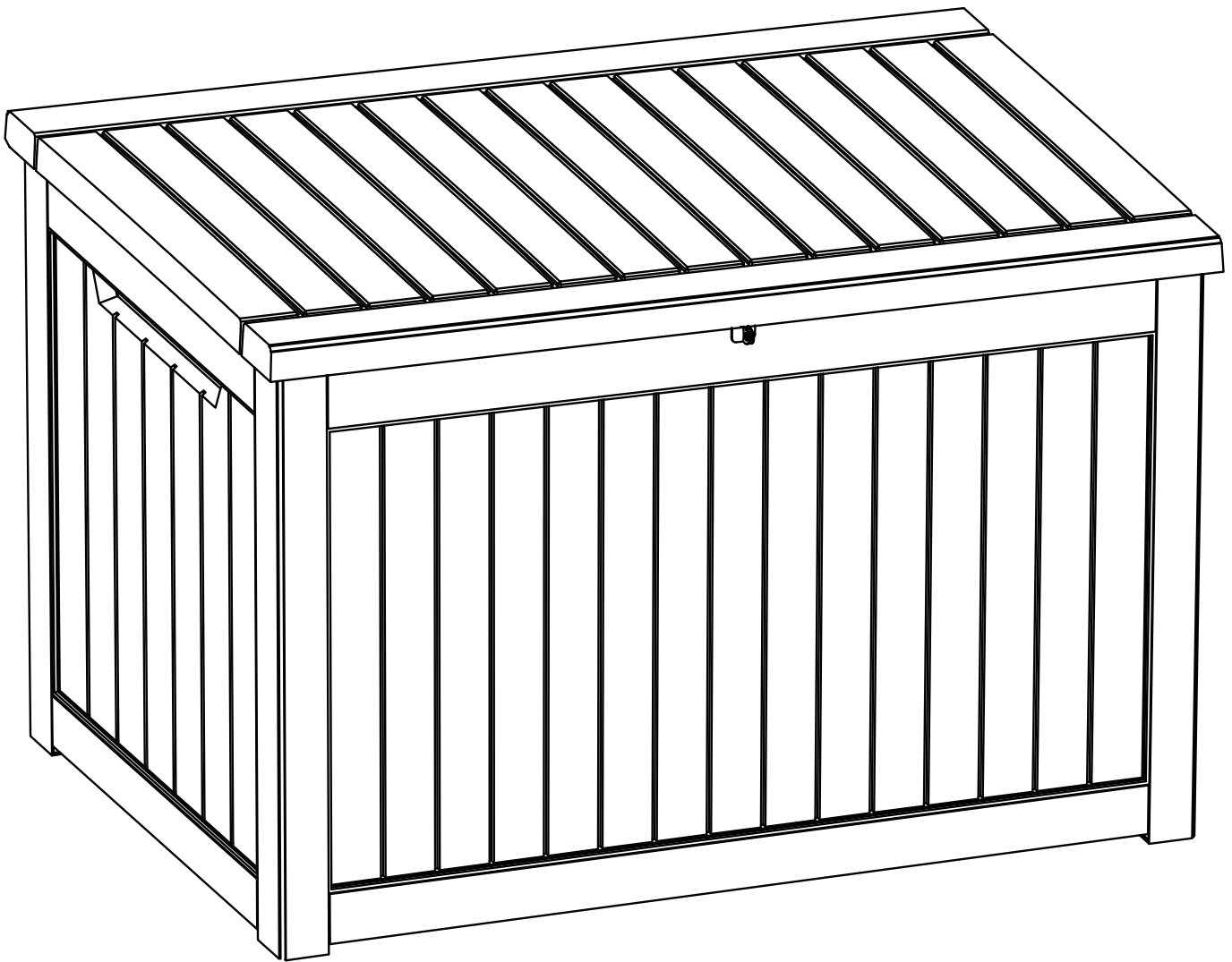

**DECK BOX**

**!** Once installed, the product cannot be detached. Strictly follow each step in the installation manual.

1. Gather and organize all required parts prior to assembly.
2. Assemble on a flat, clean and soft surface.
3. Align the holes before assembly and snap into place with a slight tap.
4. Please prepare rubber mallet in advance for convenient installation.
5. The product's structure prevents it from being conveniently assembled in low temperatures, so do not intentionally install at low temperatures.
6. During installation, please refer to the accessories guides to ensure that they are installed in the correct directions.
7. **Two or more people are required for assembly.**

### Tools Required For Assembly

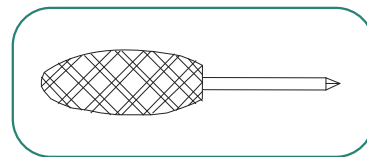

Item no.	Reference Image	Qty.	Item no.	Reference Image	Qty.
<b>A</b>		X2	<b>H</b>		X2
<b>B</b>		X1	<b>I</b>		X1
<b>C</b>		X2	<b>T</b>		X1
<b>E</b>		X1	<b>Q</b>		X2
<b>G G1</b>		X4	<b>V</b>		X1
<b>G2</b>		X4	<b>J</b>		X1
			<b>U</b>		X30
			<b>L</b>		X1
			<b>L1</b>		X2

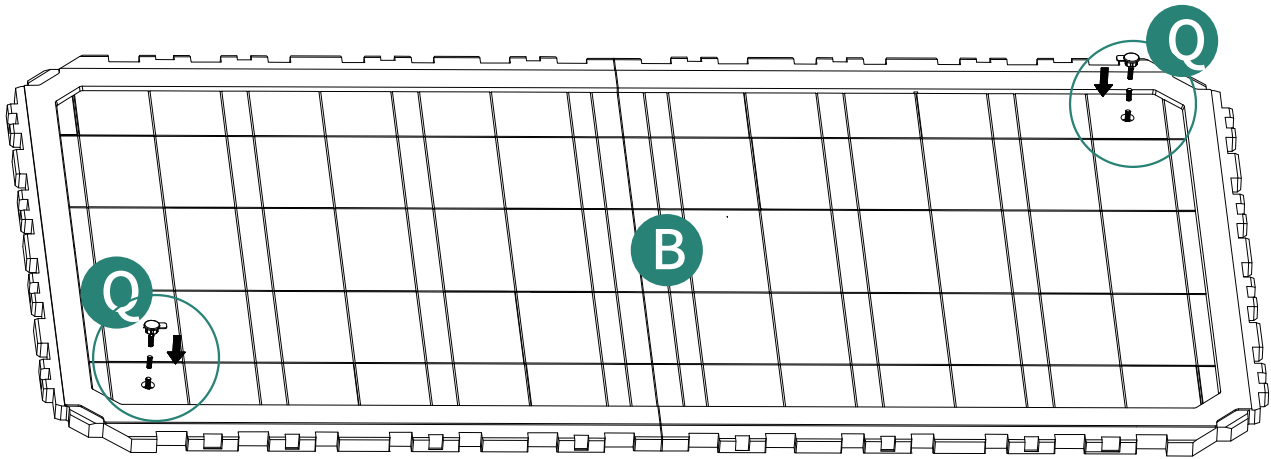
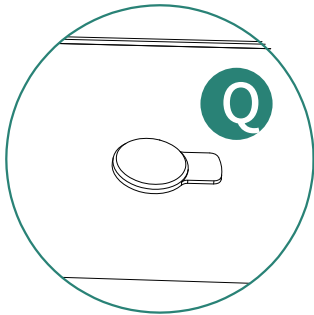
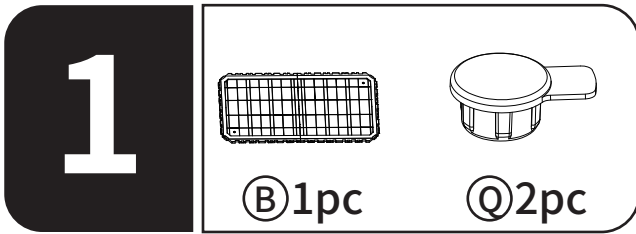

2

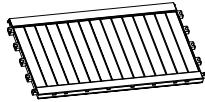

Ⓐ 2pc

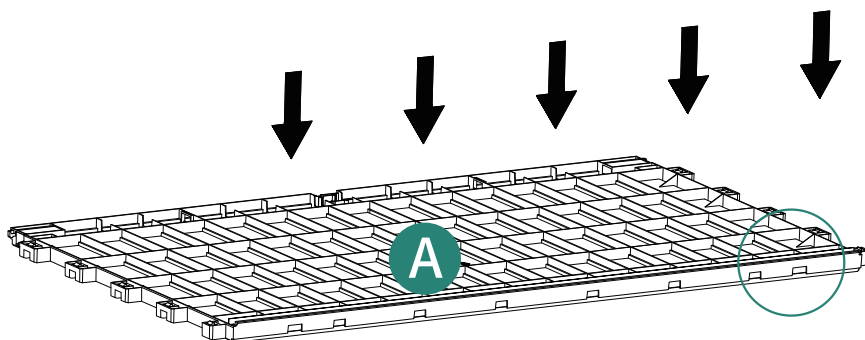
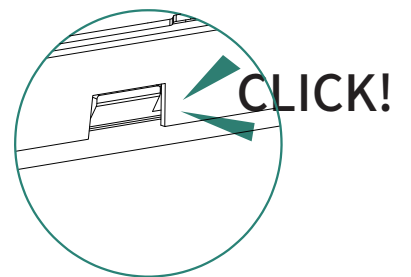
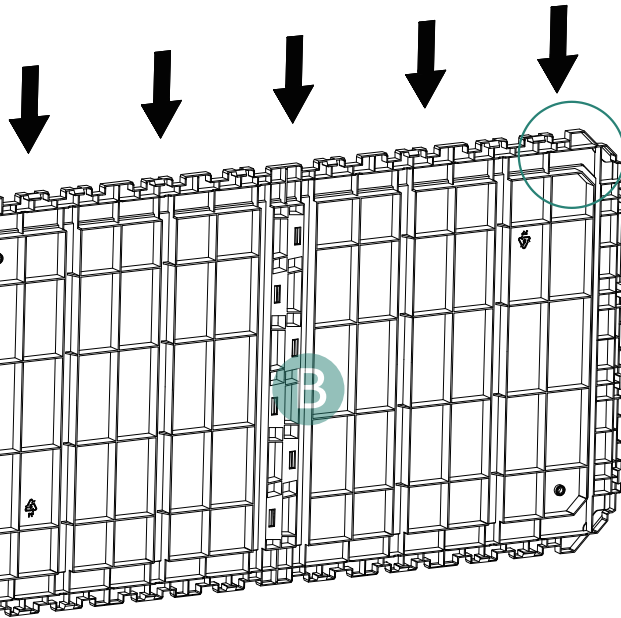
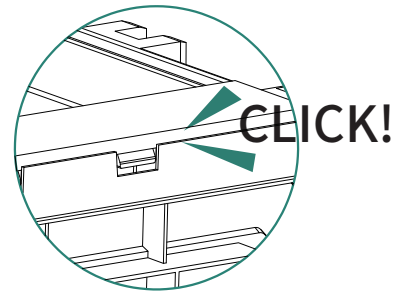
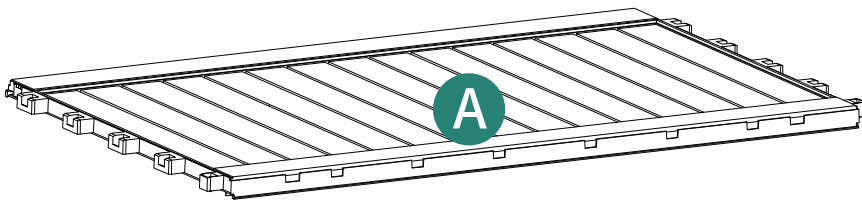

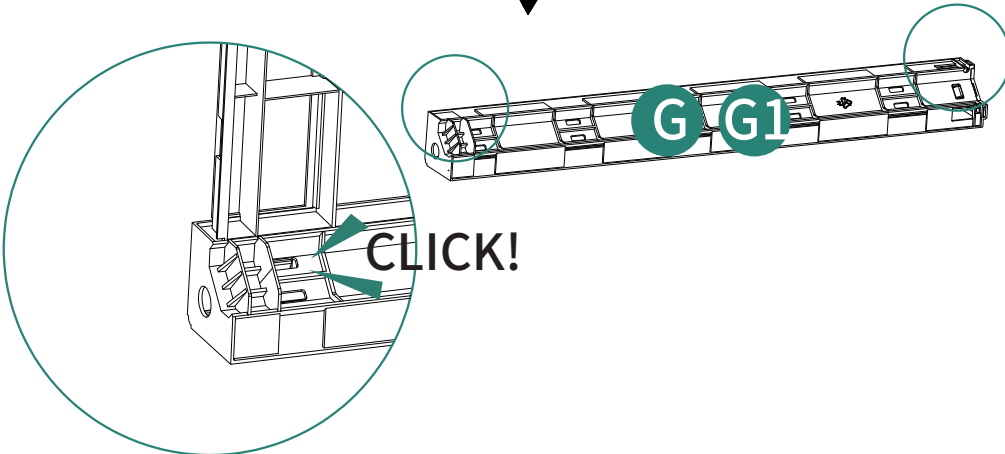
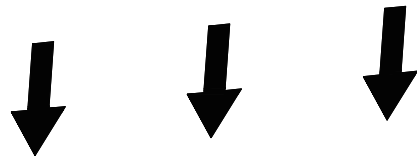
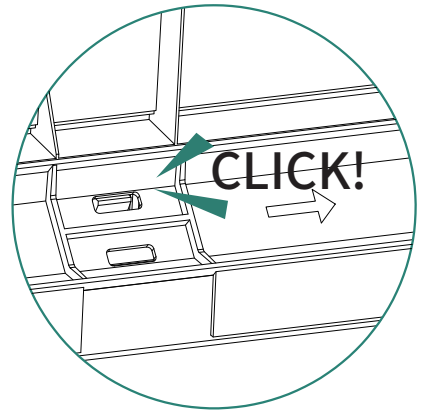
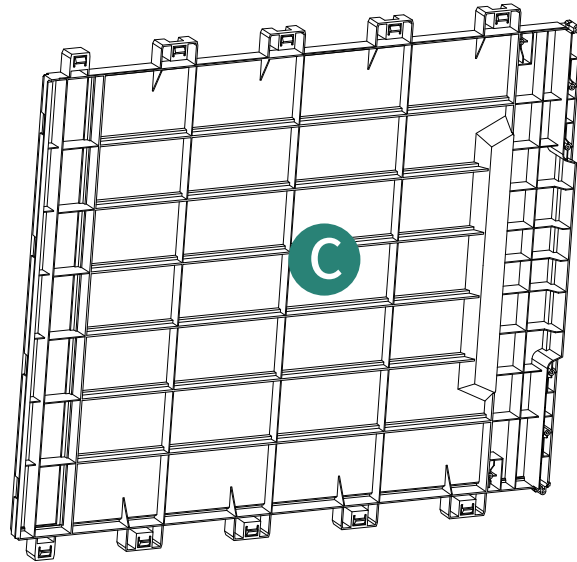
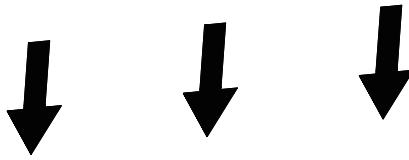
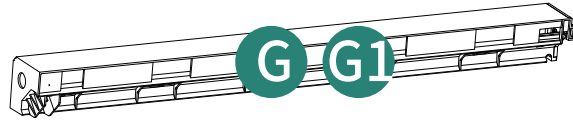
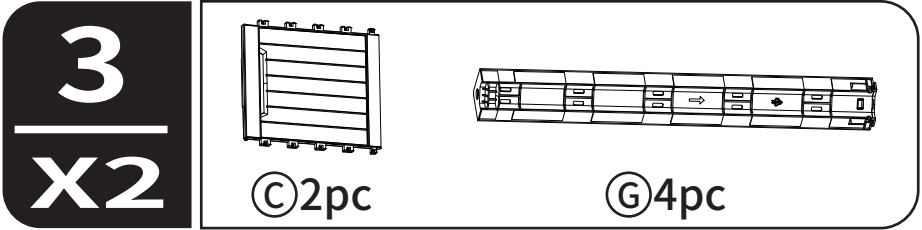

4

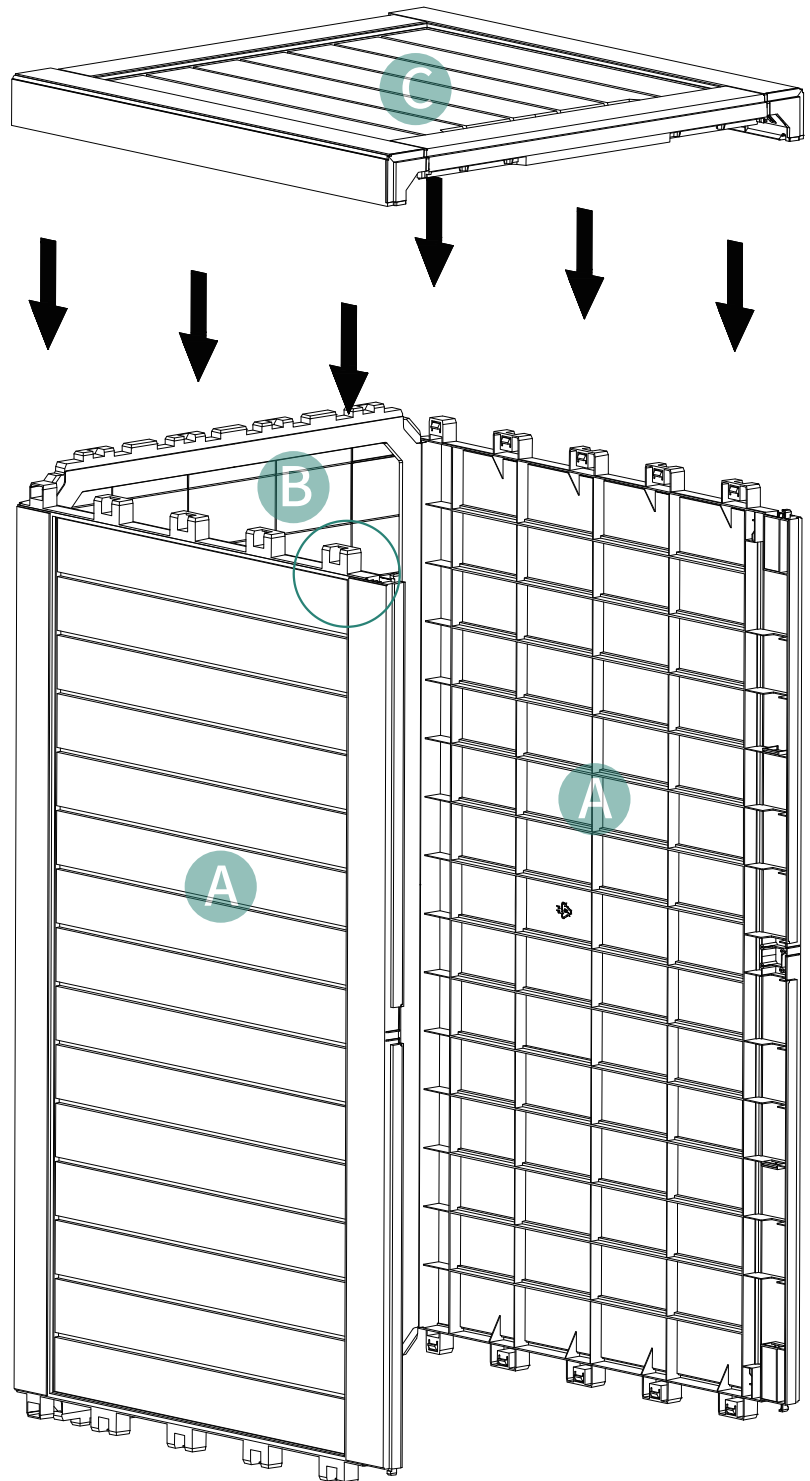
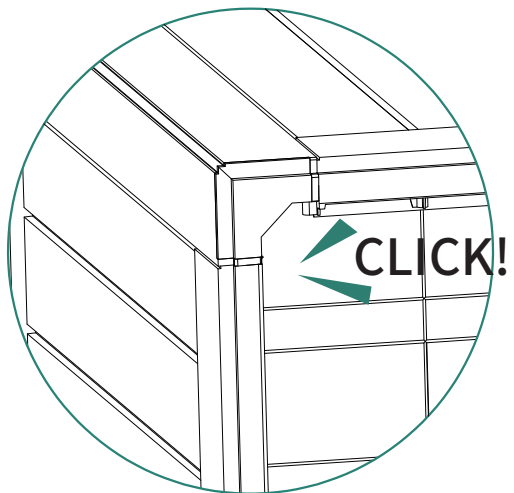

# 5



1370\*30\*15

(L1) 2pcs

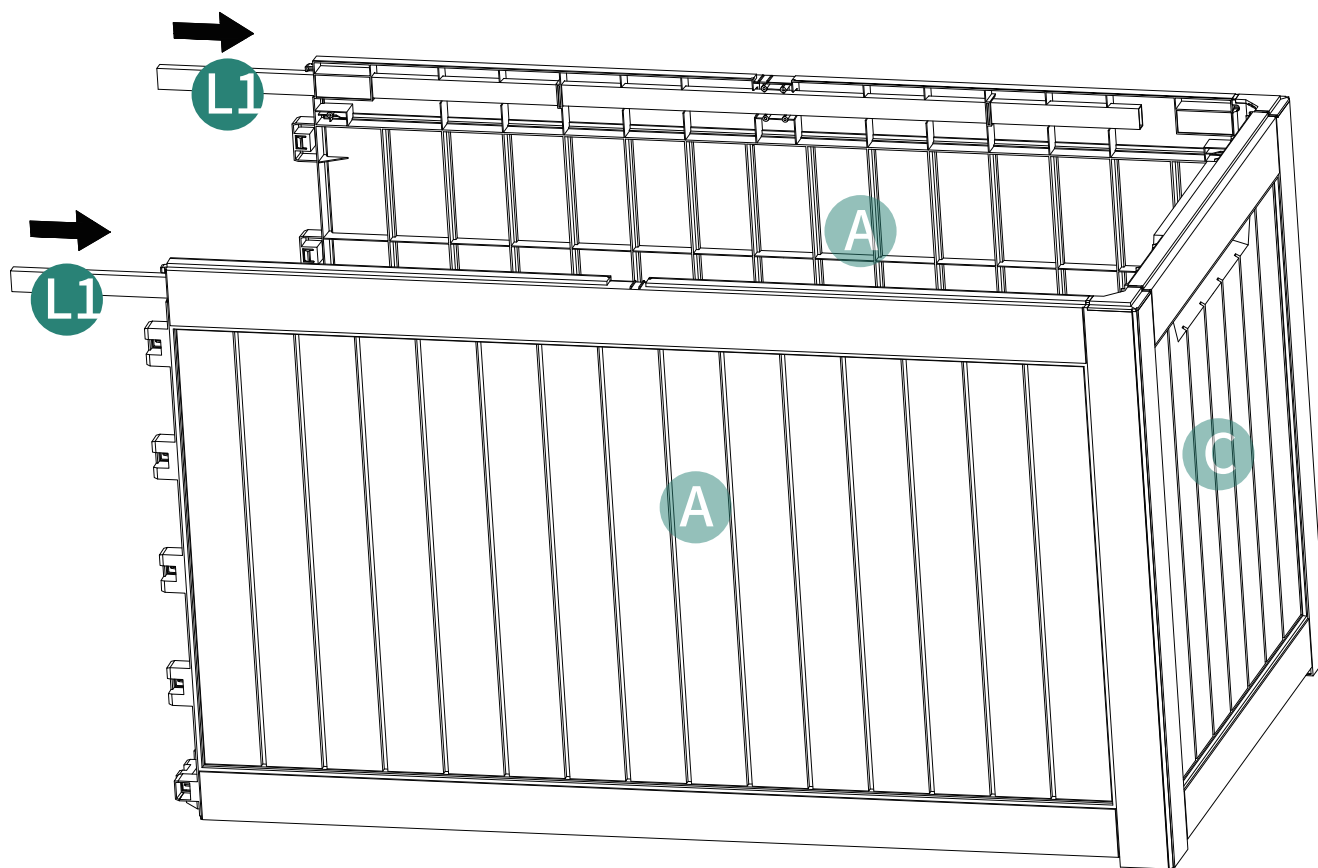

6

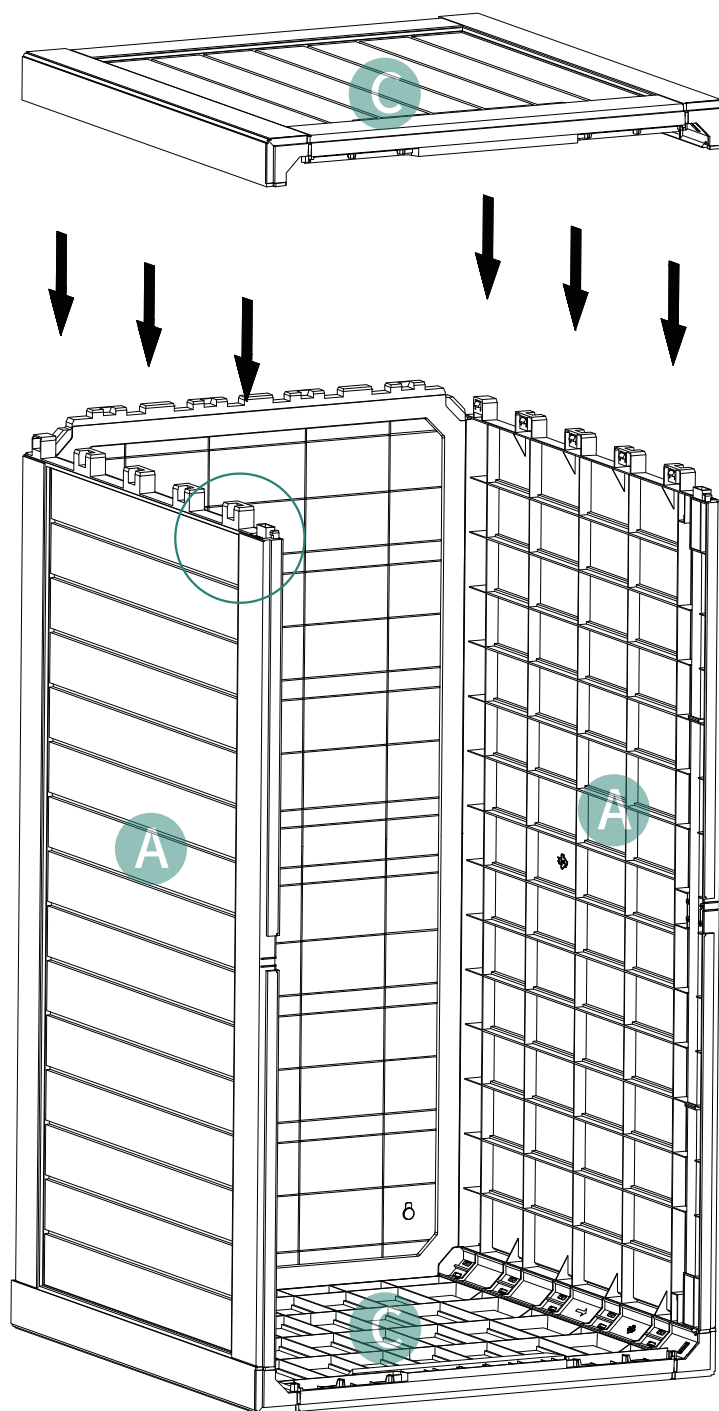
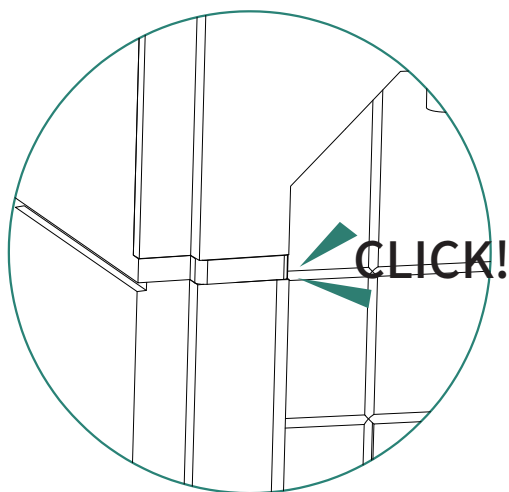

# 7

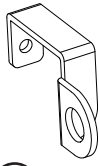

ⓐ 1pcs



ⓑ 1pcs

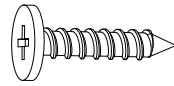

ⓒ 3pcs

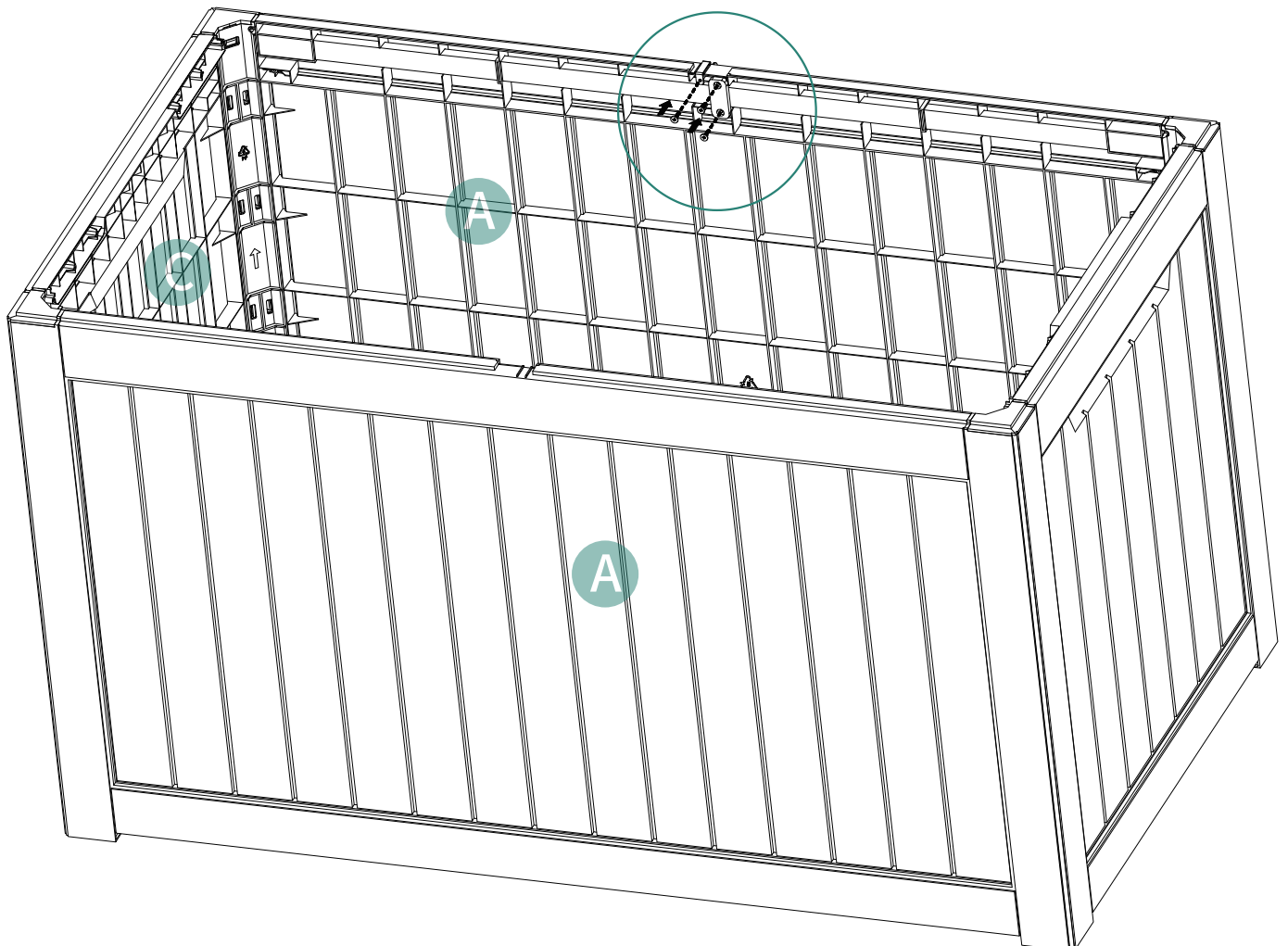
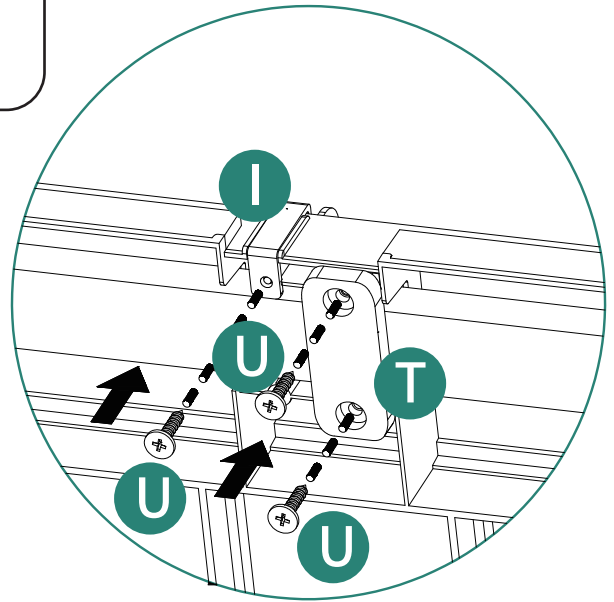

8

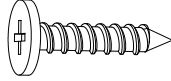
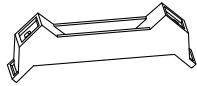

G2 4pcs

U 8pcs

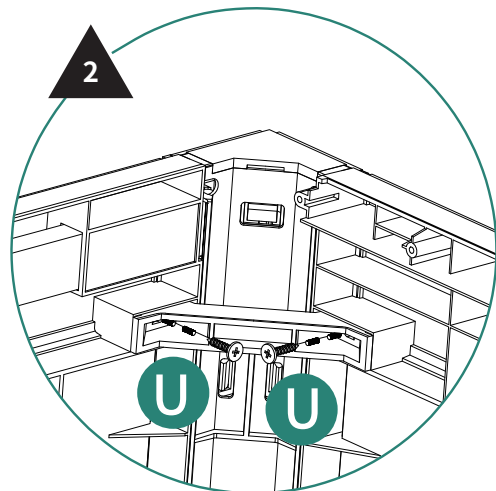
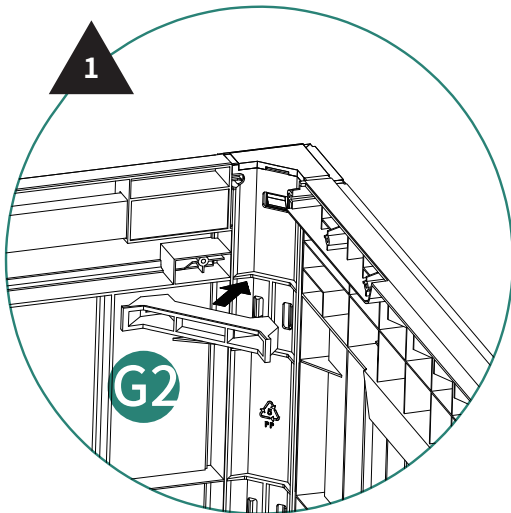
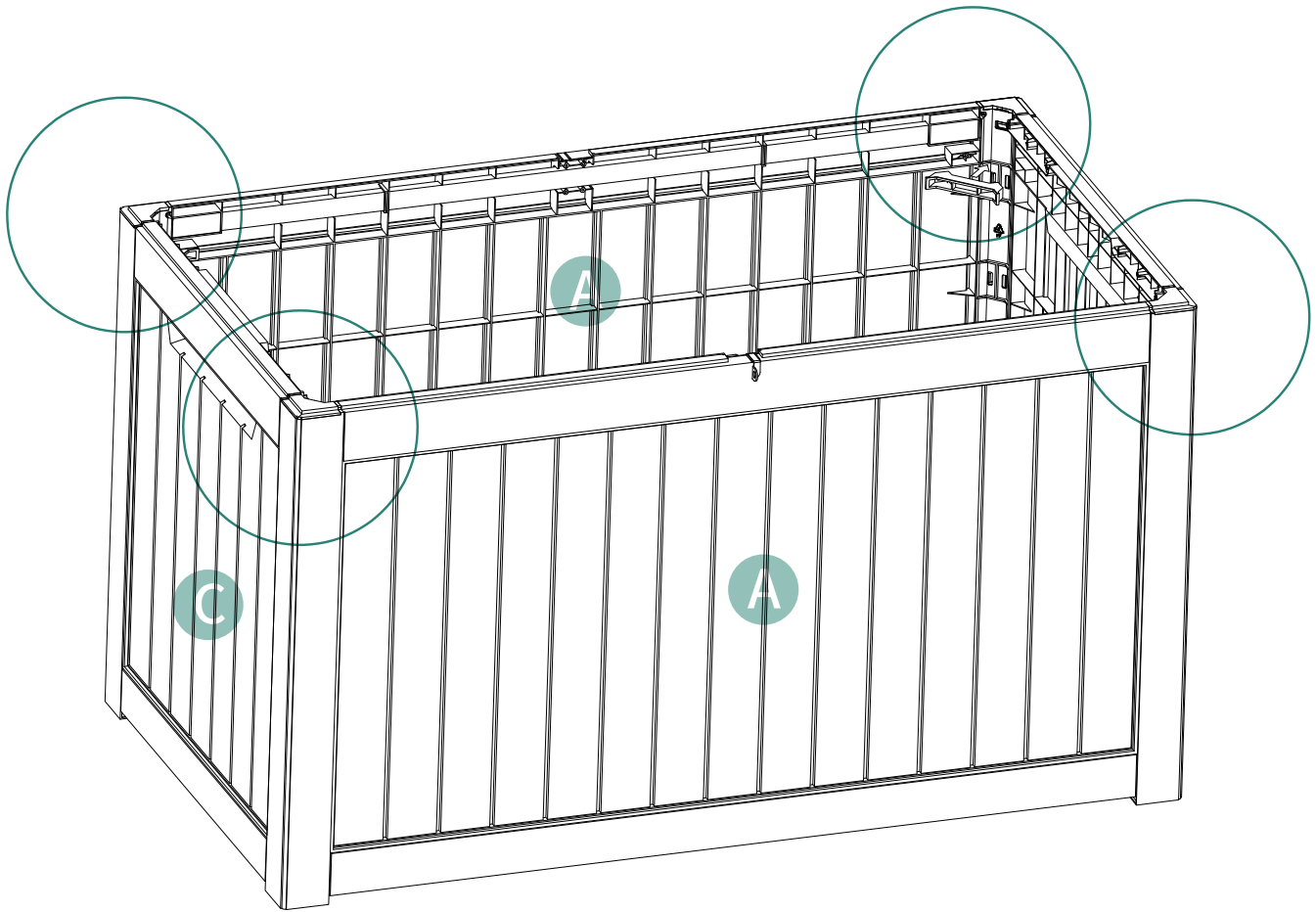

9



1460\*20\*25  
Ⓛ 1pcs

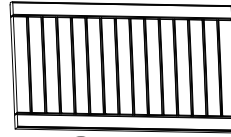

Ⓧ 1pcs

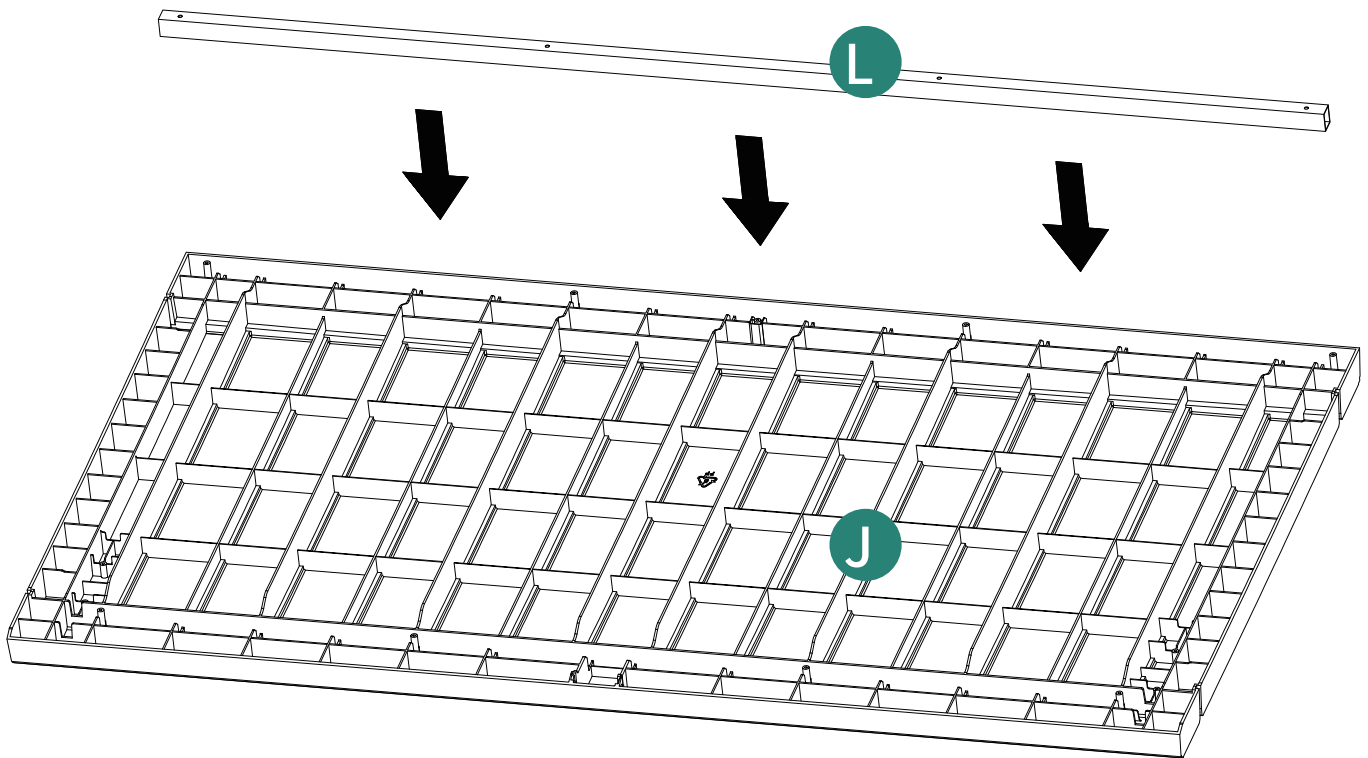

10

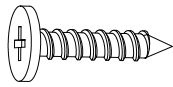

Ⓢ 4pcs

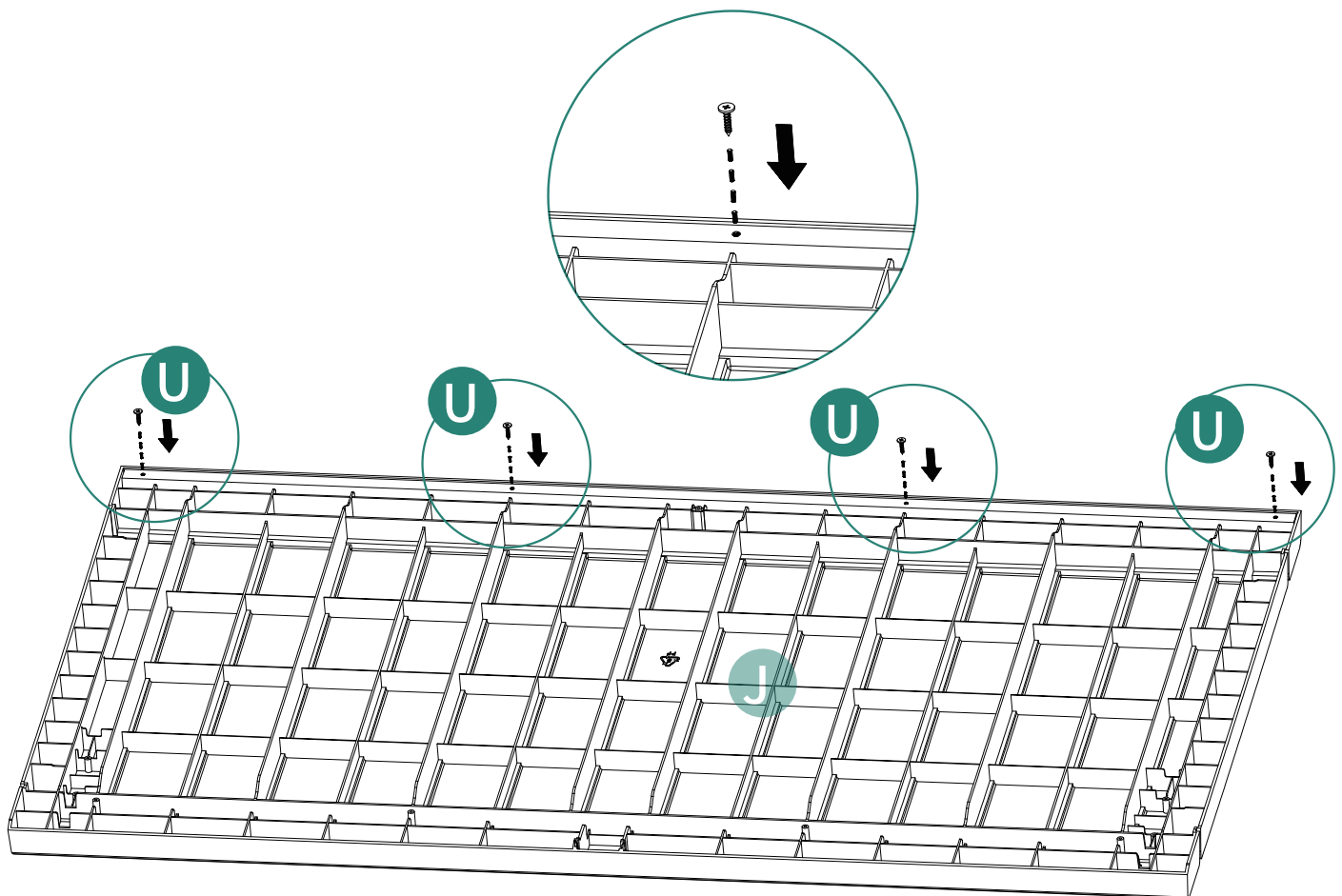

# 11

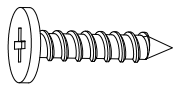

U 1pcs

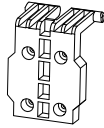

E 1pcs

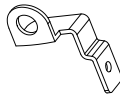

V 1pcs

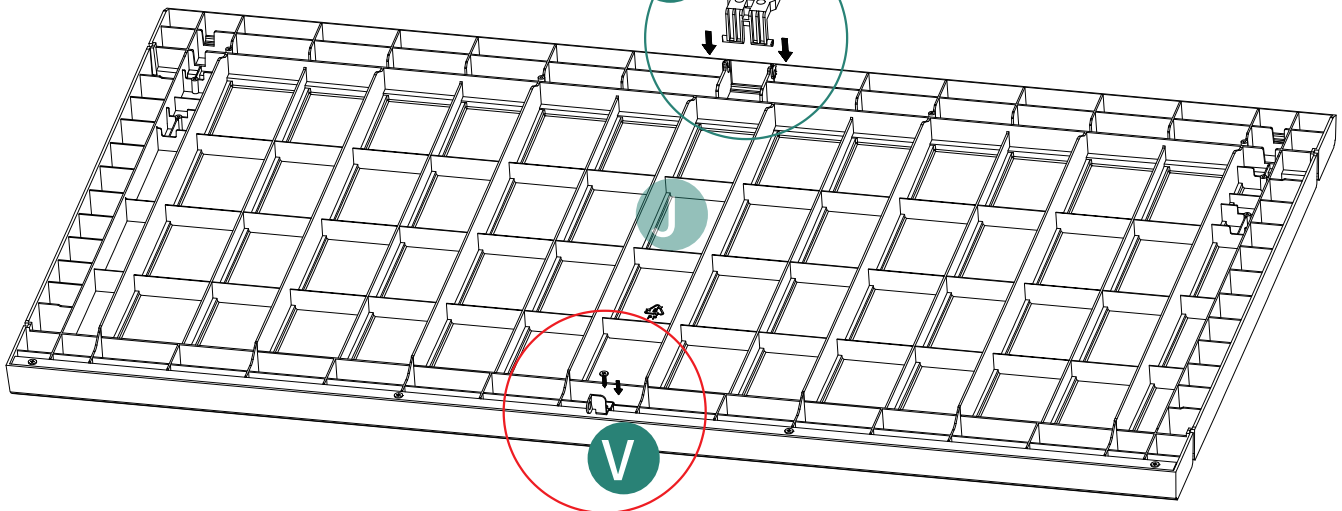
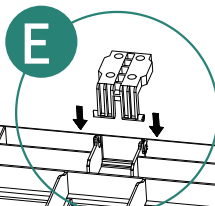
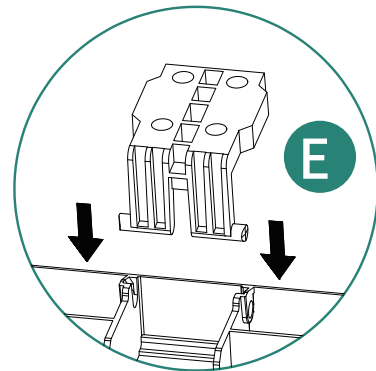
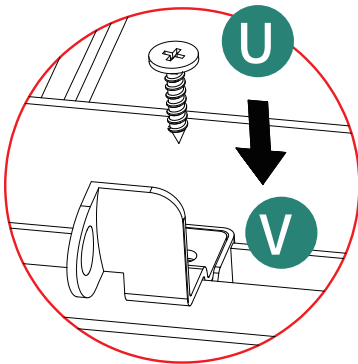

12

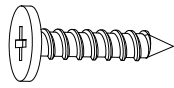

U 4pcs



H 2pcs

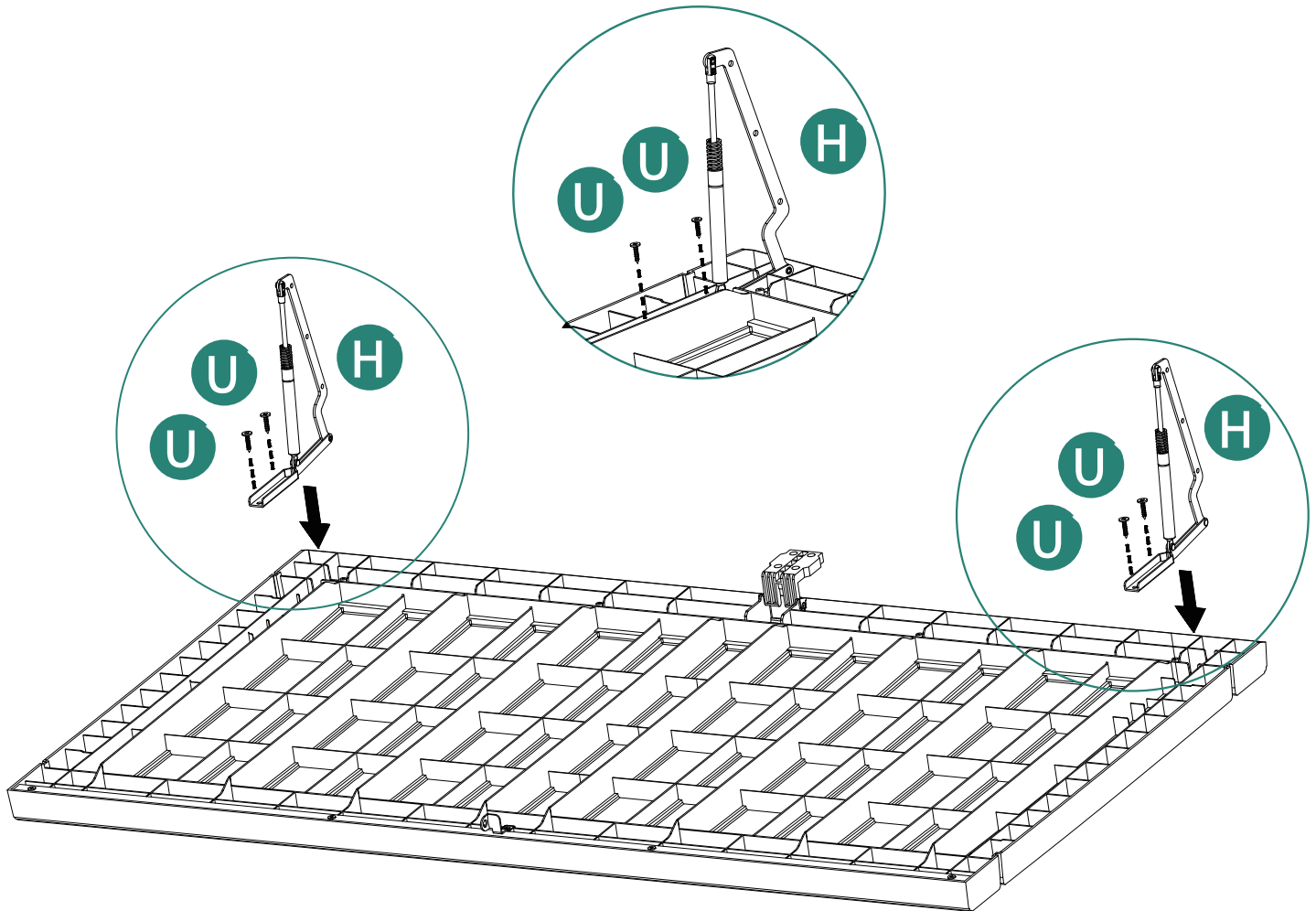

13

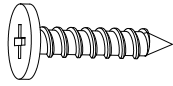

Ⓢ 10pcs

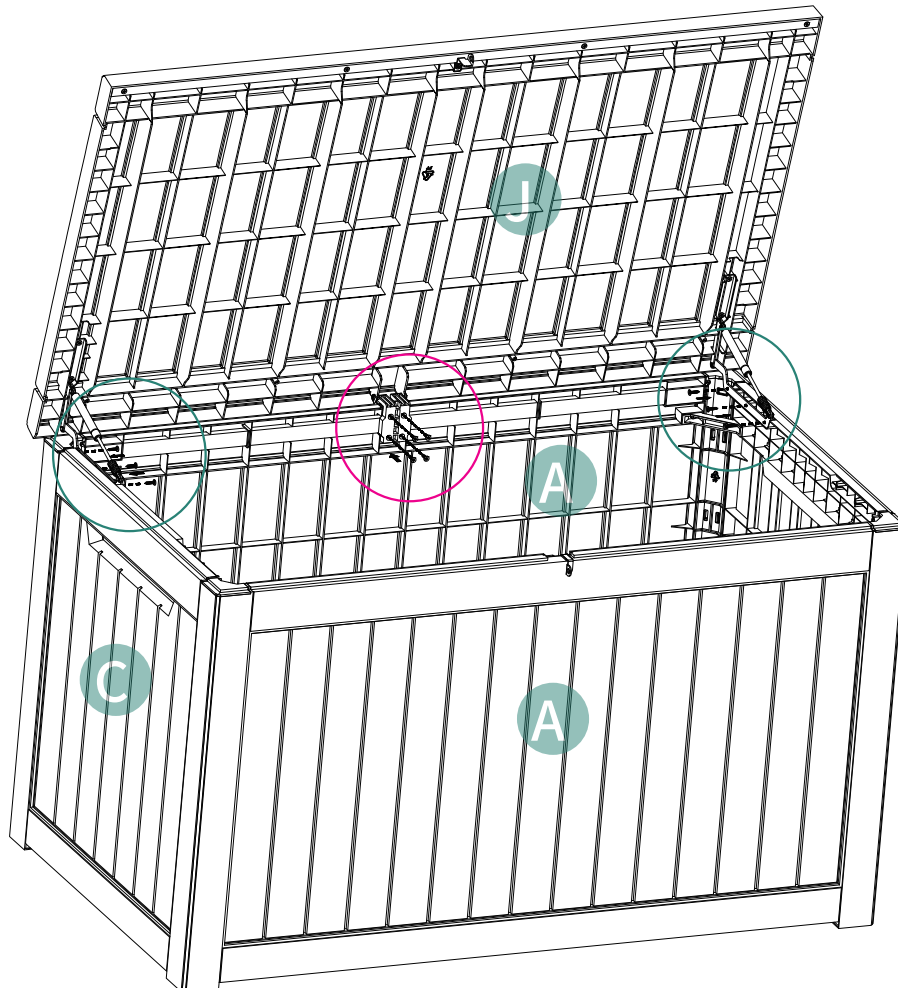
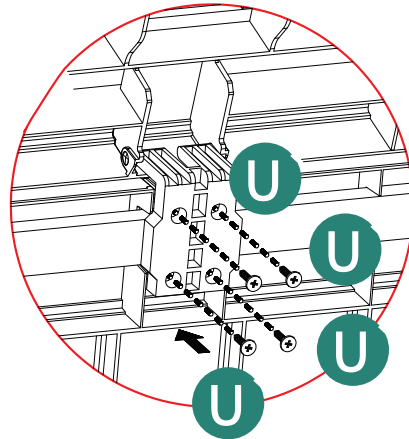
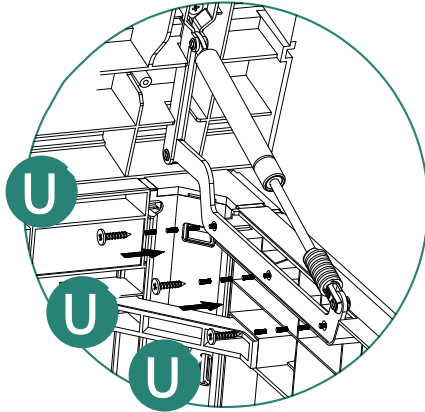

14

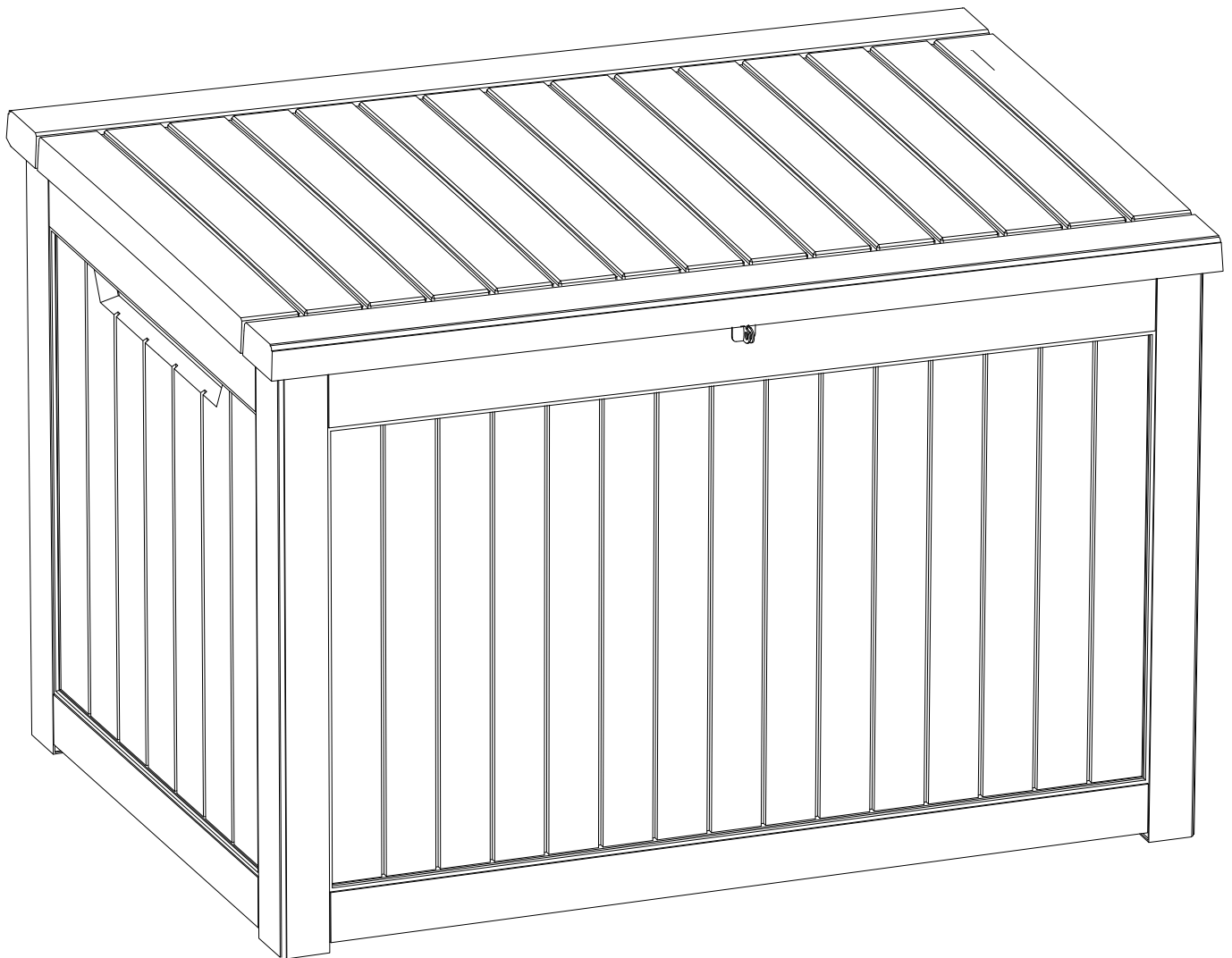

Installation Completed



Pure & Easy

## CONTACT US:

If you have any questions about the installation of YITAHOME products, just contact us at +1 (888) 717-8084 from Mon-Fri 8:00 AM-4:30 PM PST / Sat. 8:00 AM-12:00 PM PST or e-mail us at [after-sale.cs@hotmail.com](mailto:after-sale.cs@hotmail.com)

Alternative method to contact us (amazon.com orders only)

1. Log into your Amazon account
2. Go to "Your Orders" and find the purchase
3. Click on "Contact Seller"