

NOTICE

*Please make sure that you have all the listed parts and check if they are in a good condition before you assemble this item. Please refer to parts and hardware listed below for guidance.

*This item should be assembled on a soft surface to prevent any scratch on the finish when assembling the item.

*This item may require a periodic tightening.

*If you are having difficulty in assembling the item, our friendly Customer Care team is always ready to help.

PREPARATION

*Before assembling the product, make sure you have all the complete parts. Compare the parts you have to the parts listed here.

*If any part is missing or damaged, do not attempt to assemble the product.

*The Estimated Time for Assembly: 10 minutes.

*Tools Required for Assembly (included): Allen Key

CARE AND MAINTENANCE

Adhesive felt pads should always be applied to areas of furniture which make direct contact with flooring, said application will prevent damage to the furniture and or surfaces on which the furniture lies. Objects placed on articles of furniture should rest on non-abrasive material as to prevent damage to the wood finish. Objects whose composition consists of plastic and rubber are known to discolor and damage the wood surfaces on which they rest. Wipe up spills immediately and avoid common hazards such as hot dishes, harsh solvents, and abrasives. Cleaning should be done with a soft lint-free cotton cloth dampened with water or furniture polish. On highly used surfaces we recommend applying a quality paste wax which should be used on a regular basis to provide additional protection from scratches and spills. How often you apply the wax depends on how much wear the furniture receives.

Owner Manual

Product Dimensions : 27.6"W x 14.0"D x 76.0"H

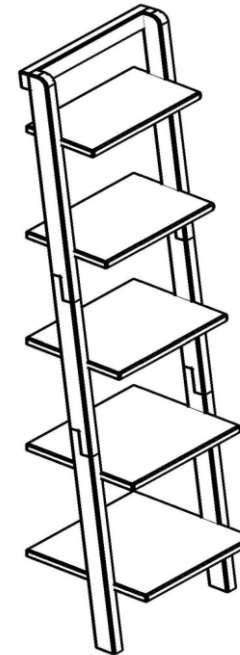









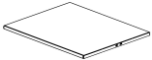

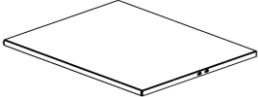
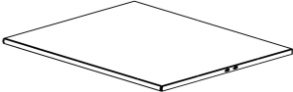
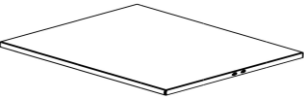

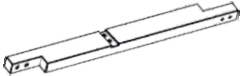

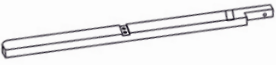
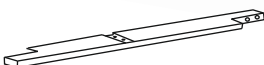

Weight capacity : 40 lbs

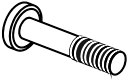
WARNING :DO NOT STAND ON THE PRODUCT

WARNING : DO NOT OVER TORQUE BOLTS

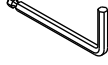
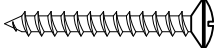
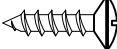
Part List and Hardware List

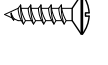
PIECE	DESCRIPTION	PICTURE	QUANTITY
A	SHELVES A		1X
B	SHELVES B		1X
C	SHELVES C		1X
D	SHELVES D		1X
E	SHELVES E		1X
F	LEFT UPPER LEG		1X
G	LEFT MIDDLE LEG		1X
H	LEFT LOWER LEG		1X
I	RIGHT UPPER LEG		1X
J	RIGHT MIDDLE LEG		1X
K	RIGHT LOWER LEG		1X
L	TOP BAR		1X

PIECE	DESCRIPTION	PICTURE	QUANTITY
HW1	BOLT M6X35MM		20X
HW2	DOWEL Ø8 X 32		14X
HW3	L PLATE		1X
HW4	FISHER S6		1X
HW5	ALLEN KEY L.4		1X
HW6	SREW 8 X1 1/4		1X
HW7	SCREW 8 x 5/8		1X
HW8	METAL PLATE		2X
HW9	SCREW 8 x 1/2		4X
HW10	FLAT WASHER 6MM		20X

PREPARATION

- * Before assembling the product, make sure you have all the complete parts. Compare the parts you have to the parts listed here.
- * If any part is missing or damaged, do not attempt to assemble the product.
- * The Estimated Time for Assembly: 10 minutes.
- * Tools Required for Assembly (included): Allen Key

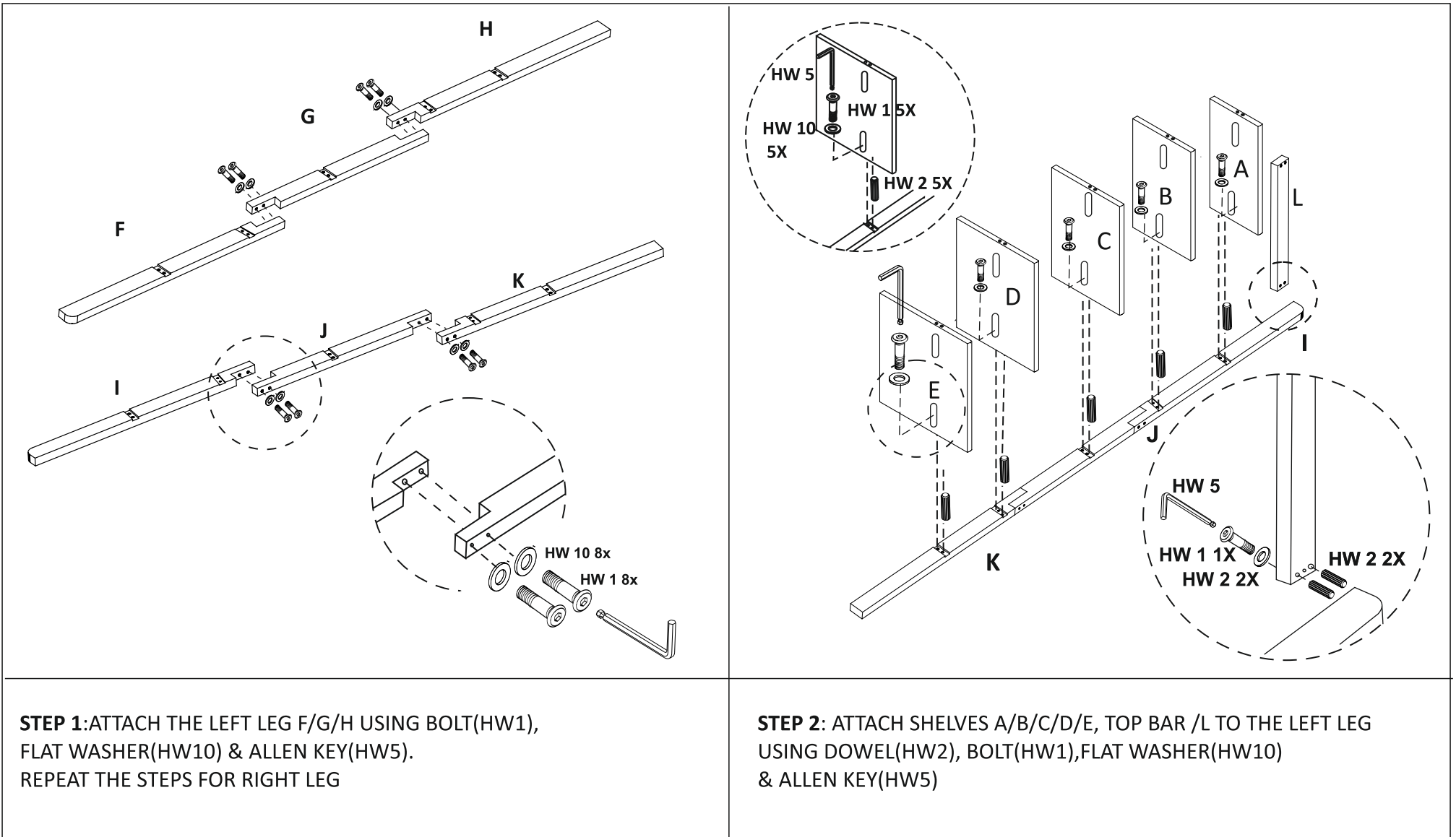

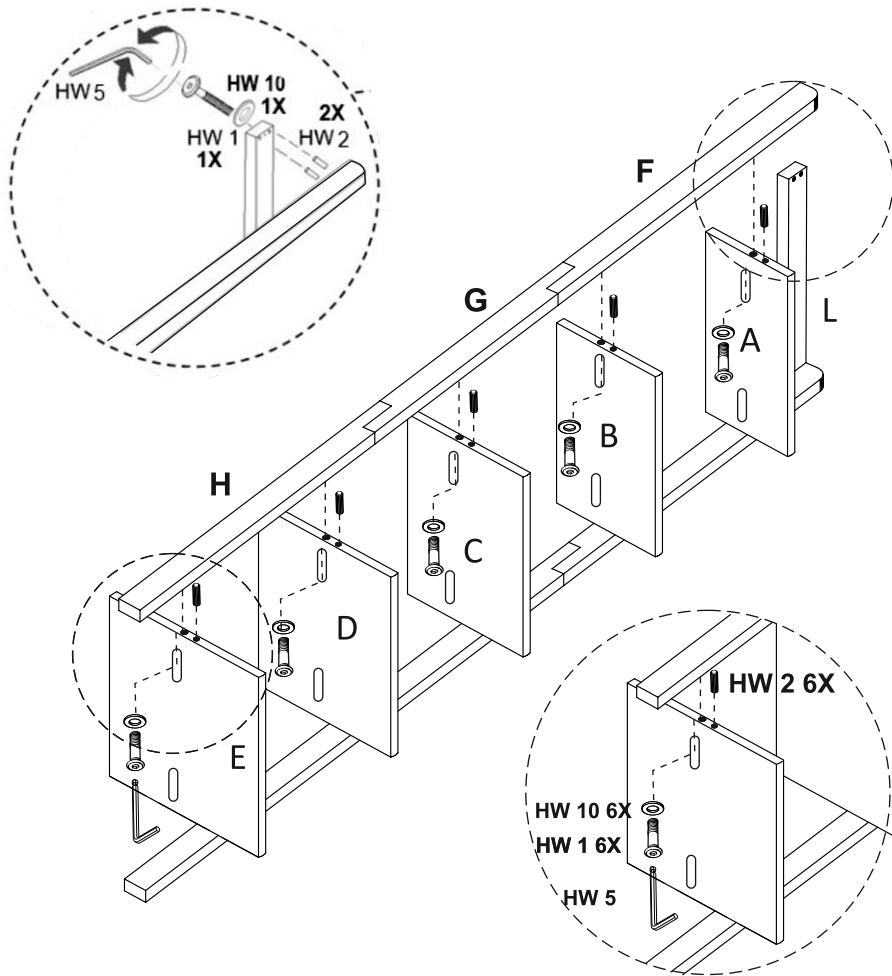

STEP 3: INSERT SHELVES A/B/C/D/E, TOP BAR /L TO THE RIGHT LEG USING DOWEL(HW2), BOLT(HW1),FLAT WASHER(HW10) AND ALLEN KEY(HW5)

WALL

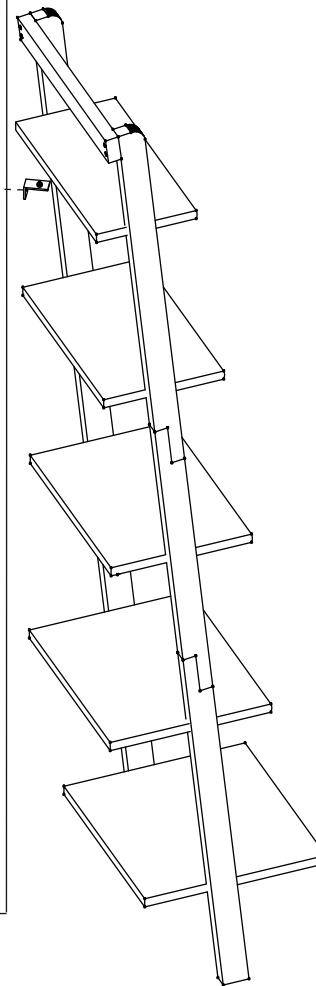

STEP 4 : ATTACH ANTI -TIP KIT TO HELP PREVENT ETORAGE FROM TIPPING

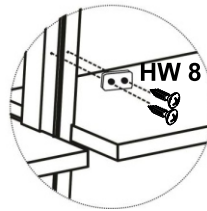
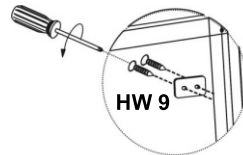
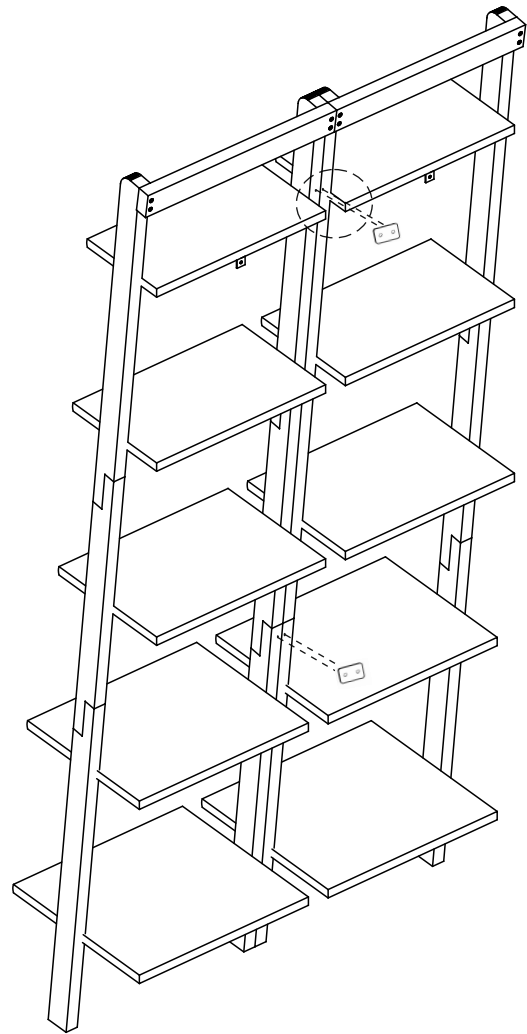

STEP 5 : THIS IS APPLICABLE ONLY TO A PAIR OF ETAGERE.
SKIP THIS INSTRUCTIONS IF YOU BUY A SINGLE ITEM .

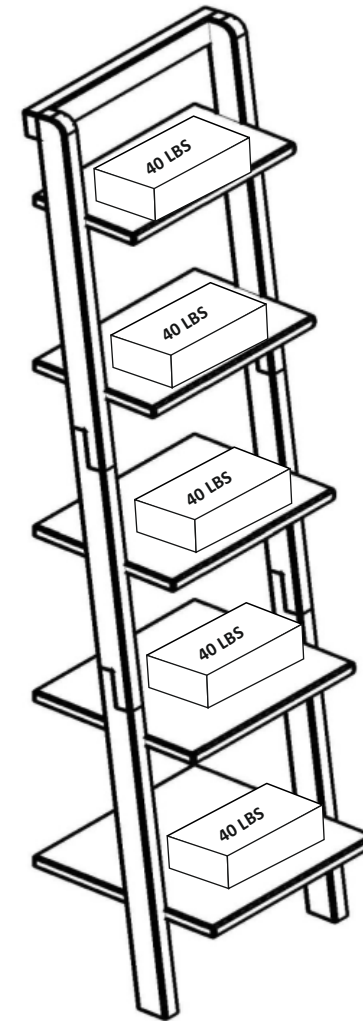

MAXIMUM WEIGHT