

Barton the LifeStyle
Home Office Patio

PATIO FOLDING SIDE AWNING 118X70 IN

ITEM: 96078

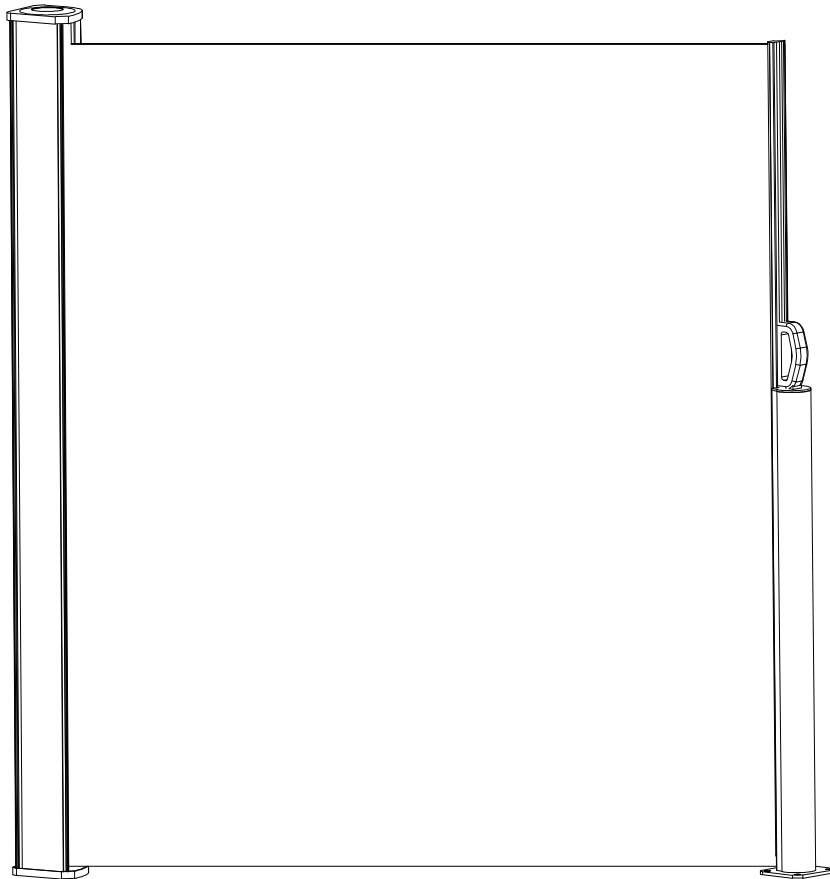

OWNER'S MANUAL AND SAFETY INSTRUCTIONS

SAVE THIS MANUAL: KEEP THIS MANUAL FOR SAFETY WARNINGS, PRECAUTIONS, ASSEMBLY, OPERATING, INSPECTION, MAINTENANCE AND CLEANING PROCEDURES. WRITE THE PRODUCT'S SERIAL NUMBER ON THE BACK OF THE MANUAL NEAR THE ASSEMBLY DIAGRAM (OR MONTH AND YEAR OF PURCHASE IF PRODUCT HAS NO NUMBER)

FOR QUESTIONS PLEASE CALL OUR CUSTOMER SUPPORT: 909.628.0880 MON-FRI 9AM TO 3PM PST



GENERAL SAFETY WARNINGS





Please read and follow all safety statements, warnings, assembly instructions, use & care directions before attempting to assemble the patio set.

- When installing and assembling, it is recommended that 2 or more adults are involved in the setup.
- This package contains small items and plastic bags that should be kept away from children.
- Ensure that all connectors & poles are firmly secured in position fully. It is important to do so before use so as to avoid collapsing or damage to the item, which could result in injury.
- **WARNING:** Keep flame and heat sources away from the cushion fabric. The fabric may burn if it is exposed to prolonged contact with a source of heat. **NEVER** barbecue near this swing or use lanterns that contain naked flames.
- **DO NOT** clean fabrics using organic solvents; do not spot clean stains - this type of fabric is not suitable for cleaning. Do not use chlorine bleach, do not dry clean.
- Avoid heavy soiling of material. Soiled coated fabrics should be cleaned by hand washing. Squeeze gently, do not rub, do not wring.
- Before assembling the patio set, check that the parts are not damaged (bent metals elements, torn fabric). In case of damages do not use the product. Contact Barton Customer Service if there are any missing or damaged parts. Failure to comply with these guidelines will/can lead to further damage and possible personal or property damage.
- Do not stand on or use any part of this item as a step ladder.
- Do not use this item in a way inconsistent with the manufacturer's instructions.

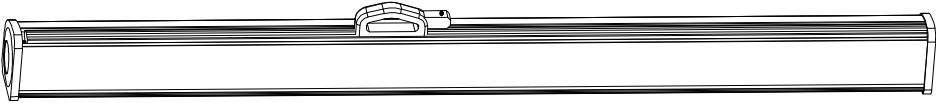
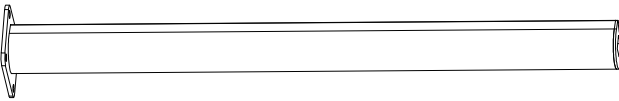
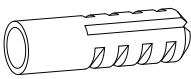
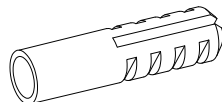

SAVE THESE WARNINGS

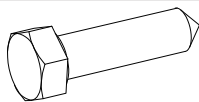
ASSEMBLY

A				1	
B				1	
D		4	G		4
E		4	H		4
F		4	I		4

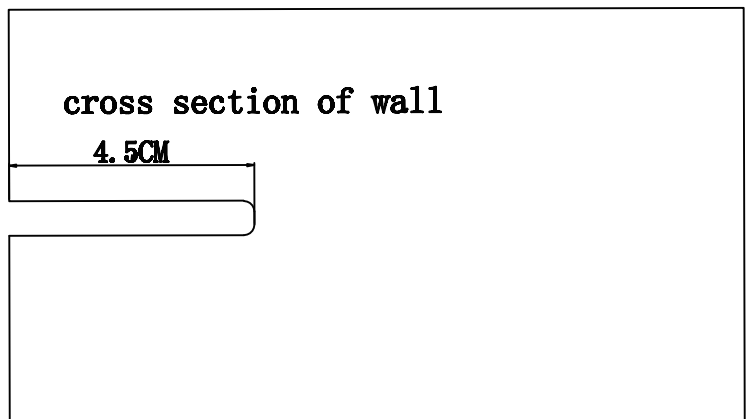
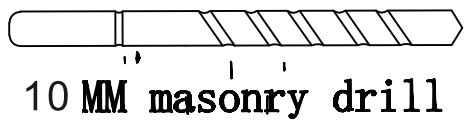

ASSEMBLY

Put the main part(A) on the wall and mark the positions for the pre-drilled holes on it.

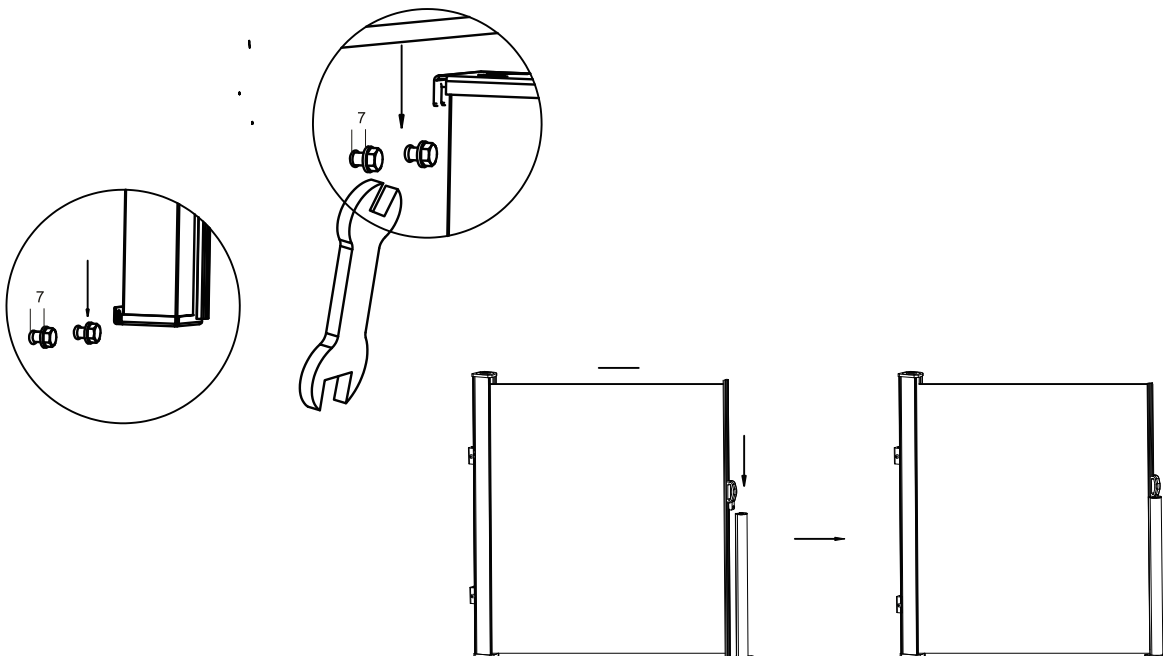
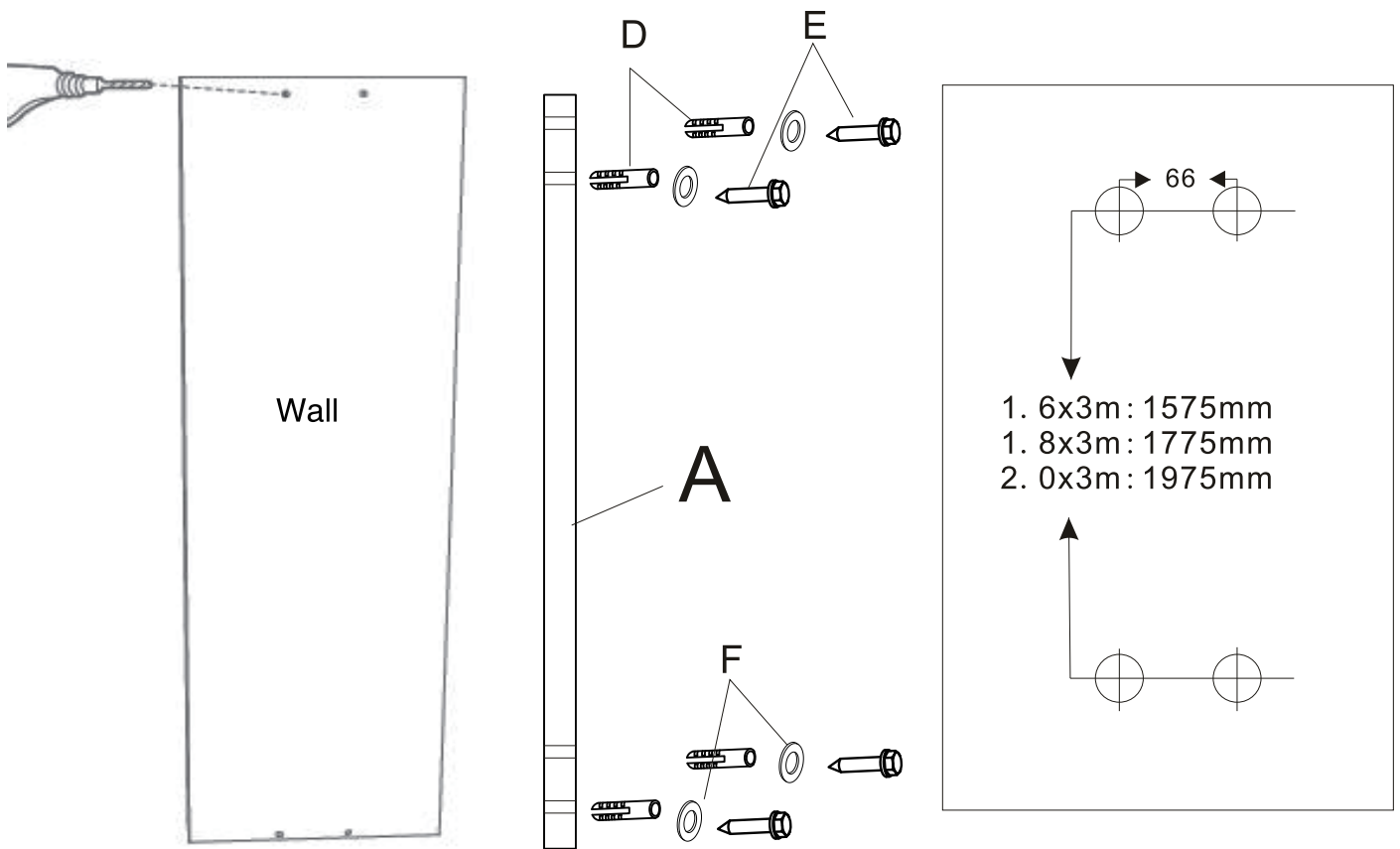

Note: The distance between A and B should not exceed 3 m. Otherwise the handle of awning fabric can not be put into the post, in other word's, the awning cloth can not be kept open.

ASSEMBLY

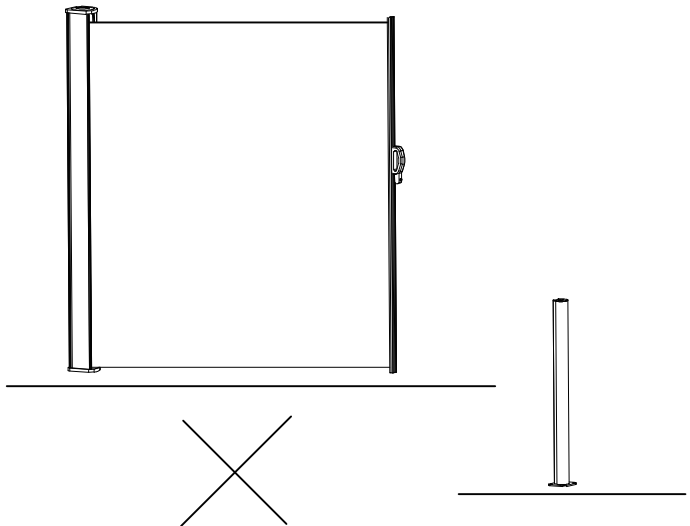
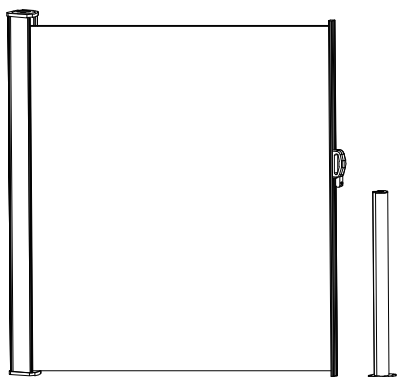
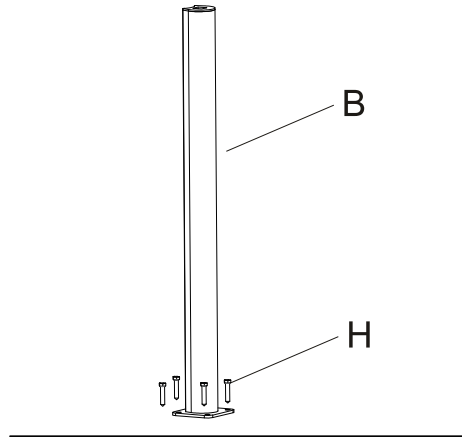
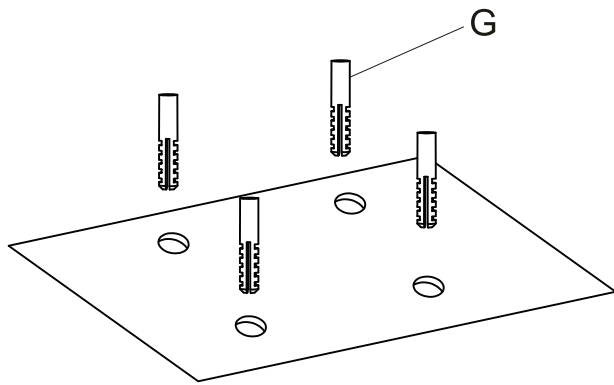
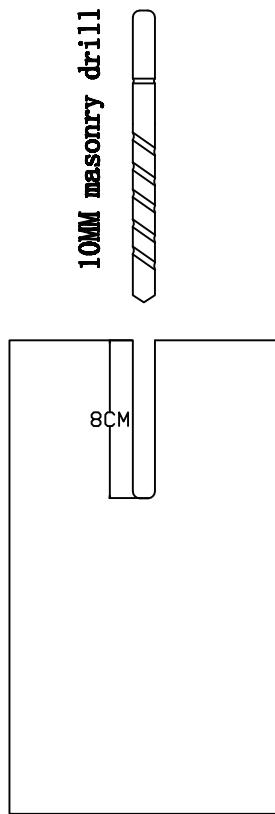

Note: When mounting the side awning, keep the main part (A) and post (B) in a straight line, or the awning fabric will be difficult to open and close.

OF NOTE

PLEASE READ THE FOLLOWING CAREFULLY

THE MANUFACTURER AND/OR DISTRIBUTOR HAS PROVIDED THE PARTS LIST AND ASSEMBLY DIAGRAM IN THIS MANUAL AS A REFERENCE TOOL ONLY. NEITHER THE MANUFACTURER OR DISTRIBUTOR MAKES ANY REPRESENTATION OR WARRANTY OF ANY KIND TO THE BUYER THAT HE OR SHE IS QUALIFIED TO MAKE ANY REPAIRS TO THE PRODUCT, OR THAT HE OR SHE IS QUALIFIED TO REPLACE ANY PARTS OF THE PRODUCT. IN FACT, THE MANUFACTURER AND/OR DISTRIBUTOR EXPRESSLY STATES THAT ALL REPAIRS AND PARTS REPLACEMENTS SHOULD BE UNDERTAKEN BY CERTIFIED AND LICENSED TECHNICIANS, AND NOT BY THE BUYER. THE BUYER ASSUMES ALL RISK AND LIABILITY ARISING OUT OF HIS OR HER REPAIRS TO THE ORIGINAL PRODUCT OR REPLACEMENT PARTS THERETO, OR ARISING OUT OF HIS OR HER INSTALLATION OF REPLACEMENT PARTS THERETO.

Record Product's Serial Number Here: _____

Note: If product has no serial number, record month and year of purchase instead.

Note: Some parts are listed and shown for illustration purposes only and are not available individually as replacement parts.



SAVE THESE INSTRUCTIONS

Questions, problems, missing parts?



Before returning to your retailer, our exceptional customer service is here to help.

Call Us: 909.628.0880

Email Us: customer@bartonliving.com

Hours of Operation: 9am - 4pm (Monday - Friday)

PRODUCT MADE IN CHINA