

Manuale di Montaggio
Assembly Instructions

SC-PRA007

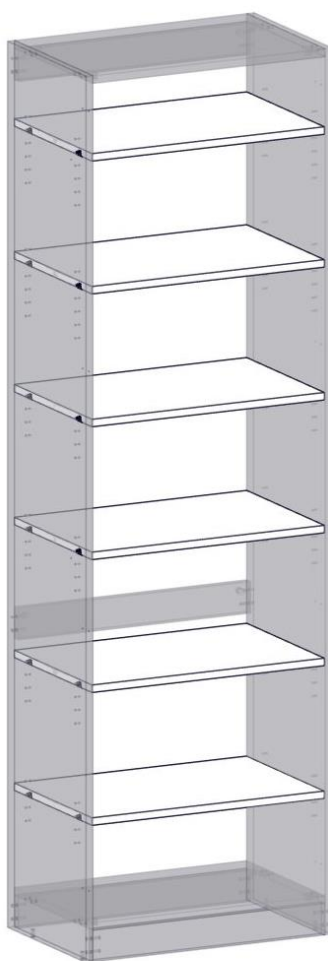

Immagini a scopo puramente illustrativo
Images merely illustrative

ISTRUZIONI DI MONTAGGIO ASSEMBLY INSTRUCTIONS

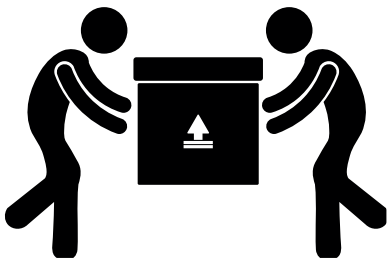

Per assemblarlo, sono necessarie **2** persone.

To assemble it, **2 people** are required.

Strumenti necessari per l'assemblaggio.
Strumenti **NON** forniti.

Tools required for assembly.
Tools **NOT** provided.

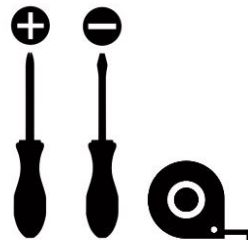

PERICOLO DI SOFFOCAMENTO - Questo prodotto contiene parti piccole. Tenere fuori dalla portata dei bambini.

CHOKING HAZARD - This product contains small parts. Keep out of reach of children.



La caduta dei mobili può causare lesioni **gravi** o **mortali**.

Fissare **SEMPRE** questo mobile alla parete con accessori di fissaggio.

NON permettere mai ai bambini di arrampicarsi o appendersi a cassetti, ante e ripiani.

Furniture tipping over can cause **serious** or **fatal** injuries.

ALWAYS secure this furniture to the wall with fixing accessories.

NEVER allow children to climb or hang on drawers, doors, or shelves.

ISTRUZIONI DI MONTAGGIO ASSEMBLY INSTRUCTIONS

Segui attentamente i passaggi di assemblaggio indicati nel manuale.

Follow the assembly steps carefully as indicated in the manual.



Prima di iniziare l'assemblaggio, identifica e separa tutte le parti e gli accessori.

Before starting the assembly, identify and separate all the parts and accessories.



Durante l'assemblaggio, tieni le parti e gli accessori organizzati per evitare incidenti.

During assembly, keep parts and accessories organized to avoid accidents.



Per proteggere i tuoi mobili, assemblalo su una superficie **pulita e piana**.

Suggerimento: Puoi utilizzare l'imballaggio del prodotto per foderare l'area dove verrà effettuato l'assemblaggio.

To protect your furniture, assemble it on a **clean and flat** surface.

Tip: You can use the product packaging to line the area where the assembly will be done.



PEZZI - PARTS

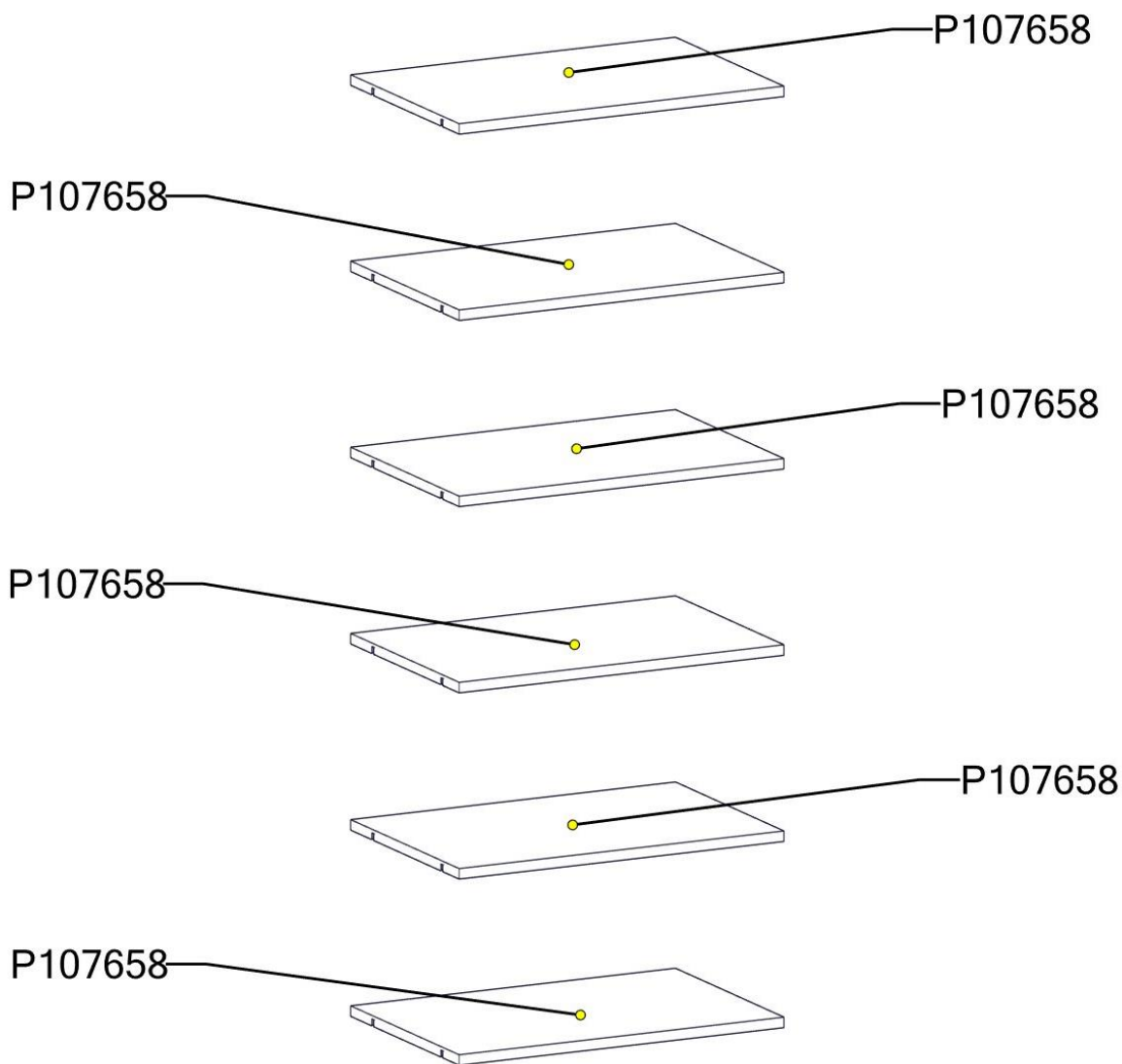

QTD.	CÓDIGO / CODE	DESCRIÇÃO	DESCRIZIONE	DESCRIPTION	C x L x E	L x W x T
6	P107658	PRATELEIRA	RIPIANO	SHELF	610 x 402 x 18 mm	24.02 x 15.83 x 0.71 in



ACCESSORI - ACCESSORIES

In caso di dubbio sulla dimensione delle viti, puoi utilizzare il righello illustrato qui sotto per verificare la misura esatta.

In case of doubt about the screw size, you can use the ruler illustrated below to check the exact measurement.

	QTD.	CÓDIGO / CODE	DESCRIÇÃO	DESCRIZIONE	DESCRIPTION
	24	077912	PARAFUSO	VITE PER TAMBURO	CAM SCREW
	24	S	TAMBOR PRATELEIRA	REGGIMENSOLA	SHELF SUPPORT

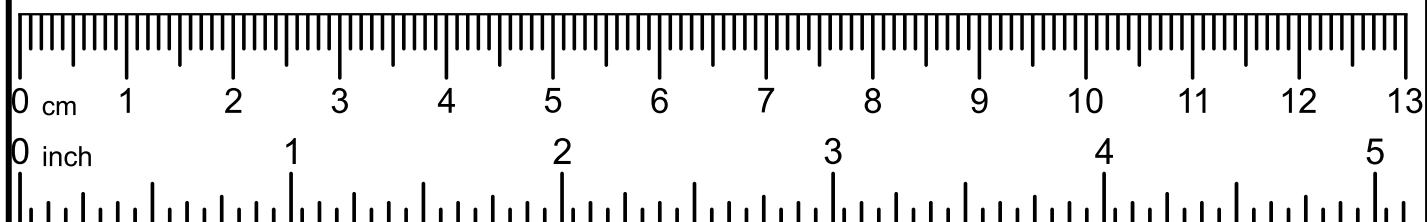

PASSO 1 / STEP 1

Cód.	Qtde.
S	24

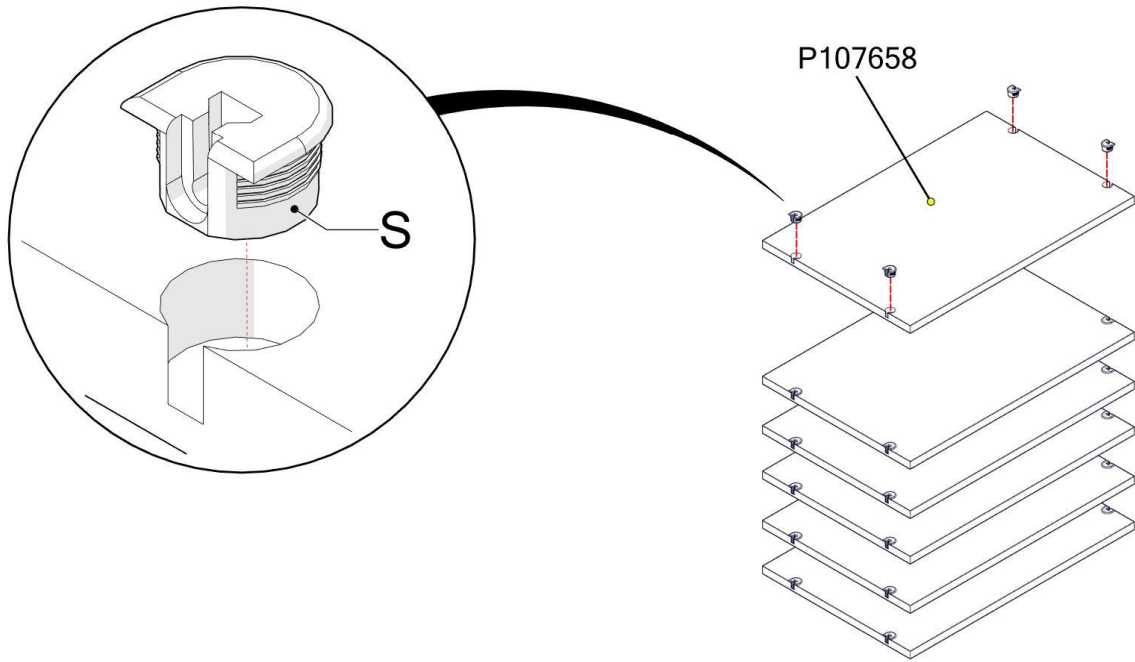

PASSO 2 / STEP 2

Cód.	Qtde.
077912	24

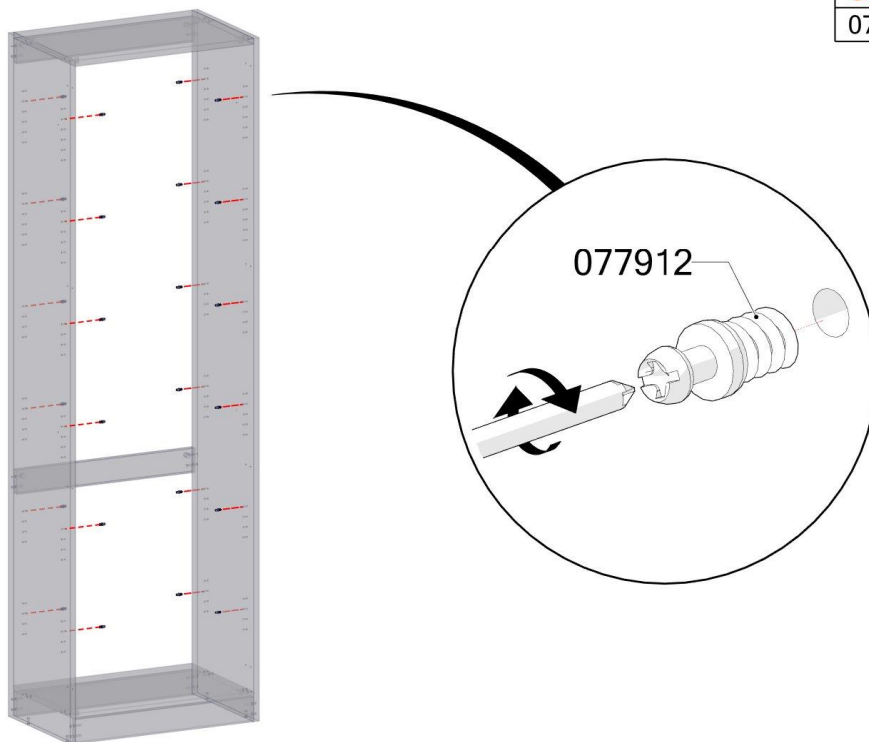

PASSO 3 / STEP 3



PASSO 4 / STEP 4

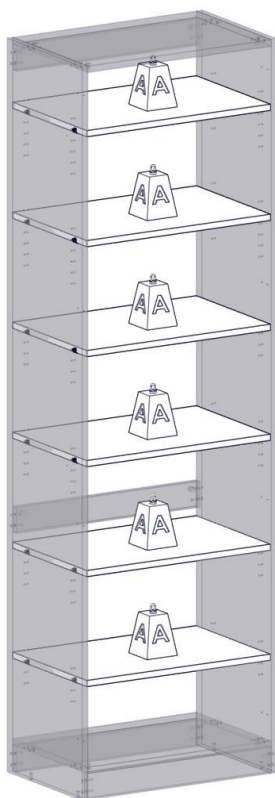

Peso supportato Weight supported

Peso massimo supportato
illustrato nel disegno, distribuito
in modo uniforme.

Maximum load weight illustrated
in the drawing distributed from
uniform way.

	KG	LB
A	7	15,43

Pulizia / Cleaning:

- Rimuovere la polvere con un panno asciutto.
- Utilizzare un panno morbido leggermente inumidito con acqua per pulire.
- Se necessario, utilizzare detergente o sapone neutro diluito in acqua.
- Non utilizzare prodotti abrasivi per evitare danni al mobile.

- Dust with a dry cloth.
- Use a soft cloth slightly dampened with water for cleaning.
- If necessary, use detergent or neutral soap diluted in water.
- Do not use abrasive products to avoid damaging the furniture.

Conservazione / Maintenance:

- Proteggi il mobile dall'umidità eccessiva.
- Evita l'esposizione diretta al sole o a fonti di calore.
- Non superare il peso massimo indicato per ripiani e cassetti.
- Serrare periodicamente le viti per mantenere la stabilità.
- Per spostare il mobile, sollevalo invece di trascinarlo.
- I mobili pesanti devono essere trasportati da due persone.

- Protect the furniture from excessive moisture.
- Avoid direct exposure to the Sun or heat sources.
- Do not exceed the maximum weight indicated for shelves and drawers.
- Tighten the screws periodically to maintain stability.
- To move the furniture, lift it instead of dragging it.
- Heavy furniture should be moved by two people.