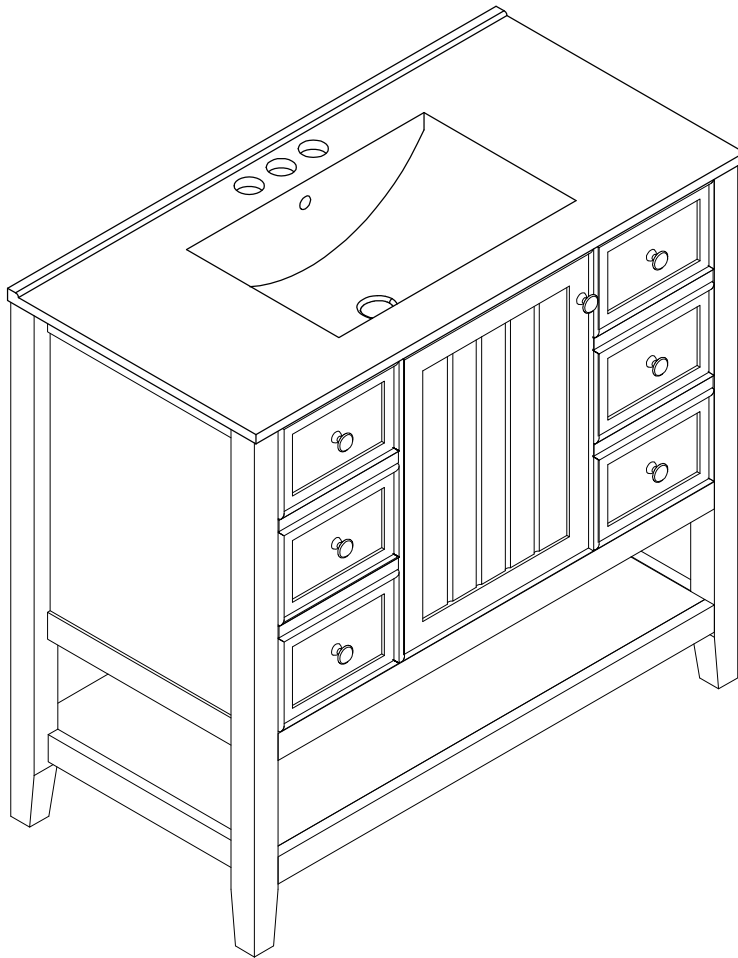


ASSEMBLY INSTRUCTIONS

36 INCH BATH VANITY - COMBO

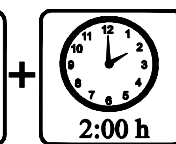
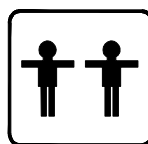
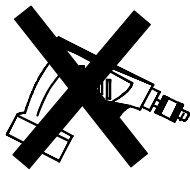


Thank you for purchasing this quality product. Be sure to check all packing material carefully for small parts which may have come loose inside the carton during shipment. Separate, identify and count all parts and hardware.

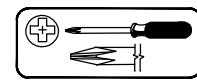
Compare with the parts list to be sure all parts are present.

"DO NOT TIGHTEN SCREWS UNTIL COMPLETELY ASSEMBLED"

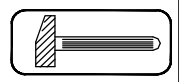
*** Use of power tool to assemble this product will invalidate any claim and damage this product making unsafe !!!**
*** Please assemble on a clean soft surface to avoid damage.**



Tools Required



(Not included)



(Not included)

IMPORTANT:

PLEASE READ INSTRUCTION BEFORE STARTING THE ASSEMBLY

Thank you for buying our products.

Please read the installation manual carefully before installation,

we need you to follow the instructions on the accessories and hardware

step by step assembly complete, our instructions are very detailed.

Products are environmentally friendly products,

Please rest assured that you do not soak in water, do not place very heavy items,

do not malicious push and pull,

if you have any problems in the process of assembly and use, please contact us.

Thank you again for your purchase of our products,

I wish you a happy life.

Before Installation

Important - Please read these instructions fully before starting assembly

Thank you for purchasing this quality product. Be sure to check all packing materials carefully for small parts, which may have come loose inside the carton during shipment. Identify and count all items according to the PARTS LIST and/or HARDWARE LIST shown below. Check you have all the components and tools listed on the following pages.

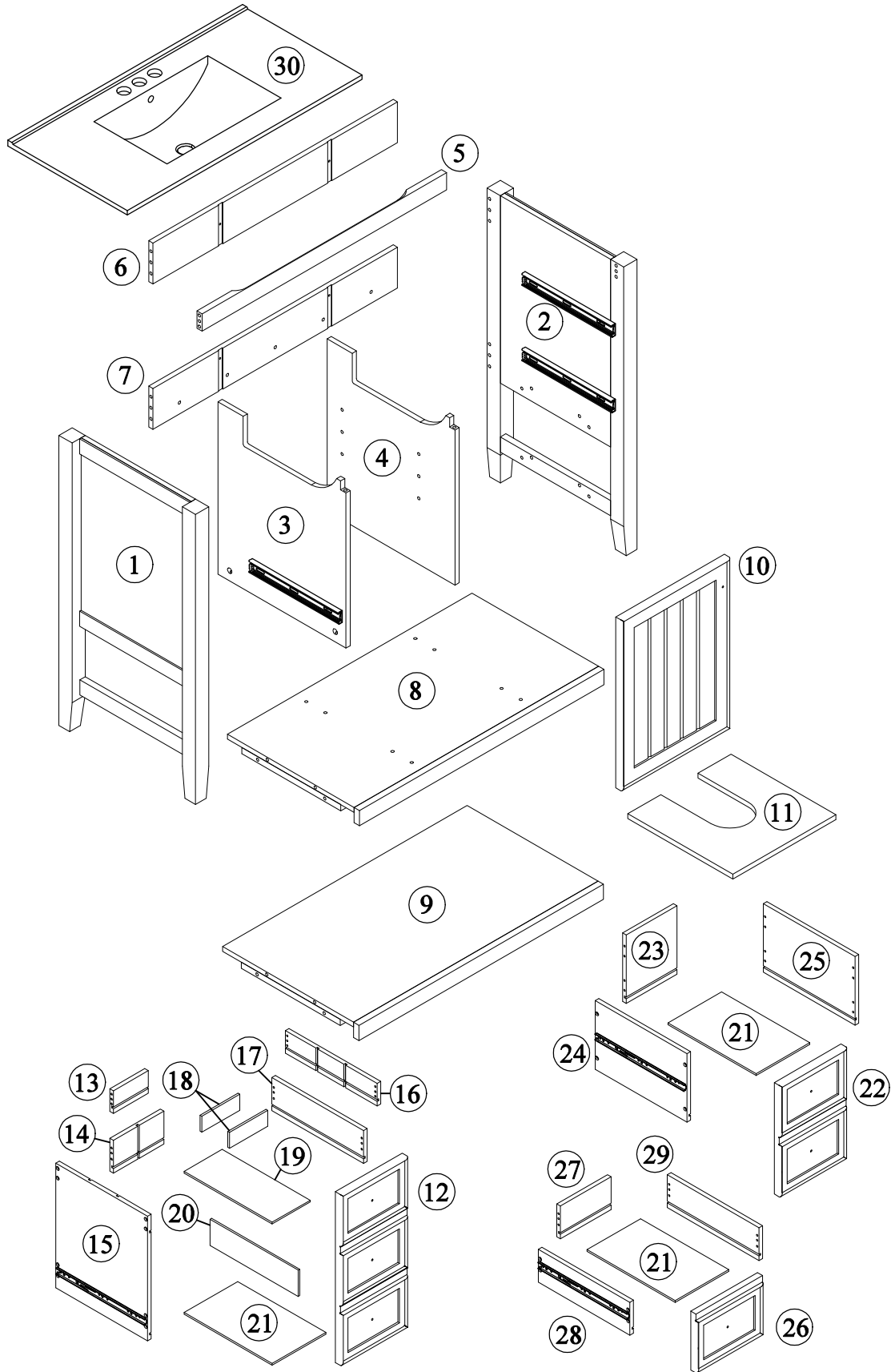
- . We recommend that you assemble this product with the assistance of another person; this will make the assembly easier, and will help eliminate damage to the product or injury to persons during assembly.
- . Please do not over tighten screws or bolts until the assembly is completed.
- . Keep children and animal away from the work area, small parts could choke if swallowed.
- . Please put all parts on a non-abrasive floor before assembly, and follow the assembly steps to assemble your newly purchased product correctly and efficiently.

If you find that you have any trouble with assembly or missing or damaged parts please contact the seller.

Cam Lock Assembly Instructions

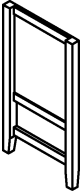
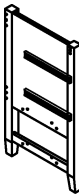



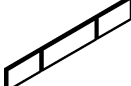
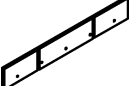
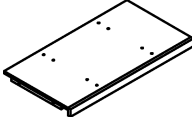
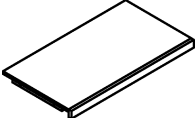
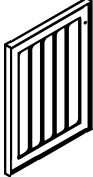
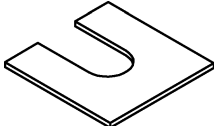


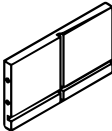
		Diagram A Insert Cam Bolt into hole as shown in diagram A.
		Diagram B Make sure not to insert the Cam Bolt: Too deep as shown in figure B as this will cause the Cam Lock to be misaligned and unable to interlock properly.
		Diagram C Also avoid inserting the Cam Bolt too close to the surface of the hole as shown in figure C, as this will cause the Cam Lock to be too loose, and not interlock properly.
		Connect the panels together.
		Insert the Cam Lock so the side opening fits over the head of the Cam Bolt.
		To tighten the Cam Lock, turn it clockwise on half a turn with a flat screwdriver. <i>*Do not use an automatic screwdriver as it may bend or break if too much power is imposed.</i>

Detail View - CABINET

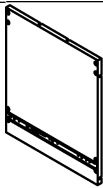
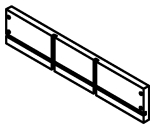
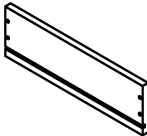

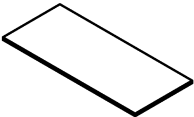
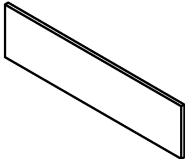
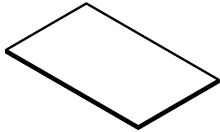
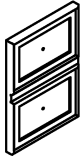
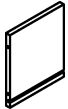
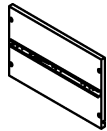
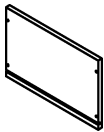
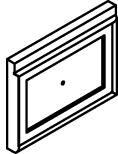
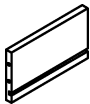
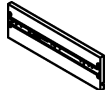
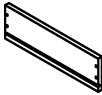
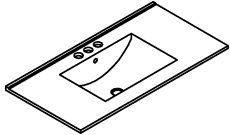


Identifying the Hardware-Identify the hardware using the illustrations below.

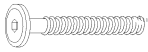

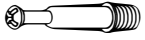

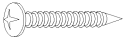


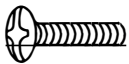
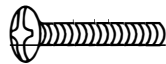







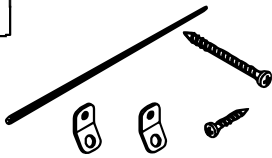

Part List

<p>1</p>  <p>Side Panel (L) - 1pc</p>	<p>2</p>  <p>Side Panel (R) - 1pc</p>
<p>3</p>  <p>Panel Mid (L) - 1pc</p>	<p>4</p>  <p>Panel Mid (R) - 1pc</p>
<p>5</p>  <p>Crossbar Top - 1pc</p>	<p>6</p>  <p>Rear Panel Top - 1pc</p>
<p>7</p>  <p>Rear Panel Bottom - 1pc</p>	<p>8</p>  <p>Frame Mid - 1pc</p>
<p>9</p>  <p>Frame Bottom - 1pc</p>	<p>10</p>  <p>Door - 1pc</p>
<p>11</p>  <p>Adjustable Shelf - 1pc</p>	<p>12</p>  <p>Left Drawer Face - 1pc</p>
<p>13</p>  <p>Left Drawer Rear panel(A) - 1pc</p>	<p>14</p>  <p>Left Drawer Rear panel(B) - 1pc</p>


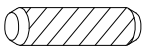

Part List

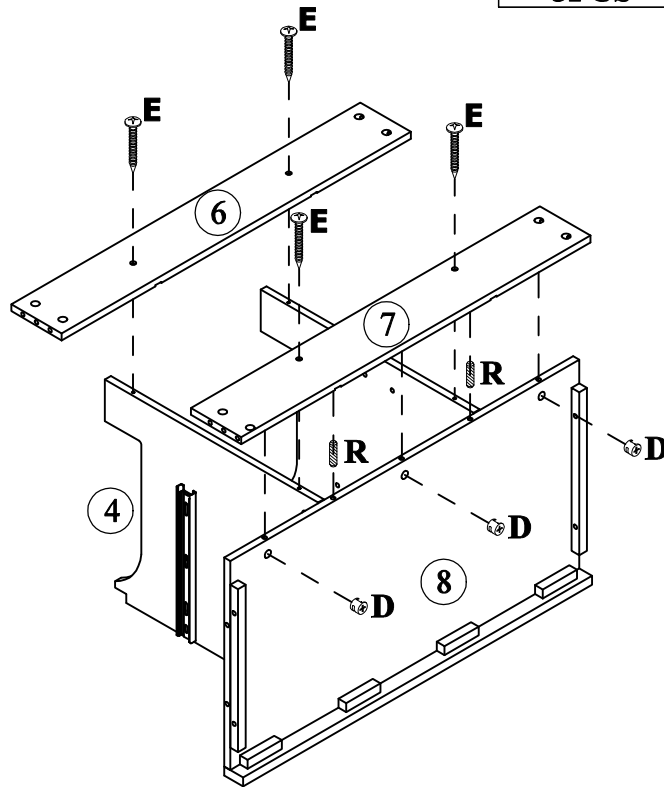
<p>15</p>  <p>Left Drawer Side panel (L) - 1pc</p>	<p>16</p>  <p>Left Drawer Side panel (R-T) - 1pc</p>
<p>17</p>  <p>Left Drawer Side panel (R-B) - 1pc</p>	<p>18</p>  <p>Drawer divide (A) - 2pcs</p>
<p>19</p>  <p>Left Drawer Bottom - 1pc</p>	<p>20</p>  <p>Drawer divide (B) - 1pc</p>
<p>21</p>  <p>Drawer Bottom - 3pcs</p>	<p>22</p>  <p>Right Drawer Face (T) - 1pc</p>
<p>23</p>  <p>Right Drawer Rear panel (T) - 1pc</p>	<p>24</p>  <p>Right Drawer Side panel (L-T) - 1pc</p>
<p>25</p>  <p>Right Drawer Side panel (R-T) - 1pc</p>	<p>26</p>  <p>Right Drawer Face (B) - 1pc</p>
<p>27</p>  <p>Right Drawer Rear panel (B) - 1pc</p>	<p>28</p>  <p>Right Drawer Side panel (L-B) - 1pc</p>
<p>29</p>  <p>Right Drawer Side panel (R-B) - 1pc</p>	<p>30</p>  <p>Sink - 1pc</p>

Hardware List



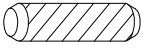
<p>A</p>  <p>ø13x1/4"x28mm</p>	<p>B</p>  <p>ø1/4"x16x1mm</p>	<p>C</p>  <p>ø6x35mm</p>
<p>Hex-Head bolts (8pcs)</p>	<p>Washer (8pcs)</p>	<p>Three in one bolts (17pcs)</p>
<p>D</p>  <p>ø14.5x12mm</p>	<p>E</p>  <p>ø8xø4x25mm</p>	<p>F</p>  <p>ø8xø4x32mm</p>
<p>Three in one lock (17pcs)</p>	<p>Round head screw (4pcs)</p>	<p>Round head screw (32pcs)</p>
<p>G</p> 	<p>H</p>  <p>ø5/32"x15mm</p>	<p>I</p>  <p>ø5/32"x20mm</p>
<p>Handle (7pcs)</p>	<p>Handle screw (3pcs)</p>	<p>Handle screw (4pcs)</p>
<p>M</p> 	<p>N</p>  <p>ø7xø3.5x12mm</p>	<p>O</p> 
<p>L-Bracket (2pcs)</p>	<p>Round head screw (4pcs)</p>	<p>Laminate pad(4pcs)</p>
<p>P</p> 	<p>Q</p>  <p>ø7xø3.5x15mm</p>	<p>R</p>  <p>ø8x30mm</p>
<p>Damping hinge (2pcs)</p>	<p>Flat head screw (12pcs)</p>	<p>Wood dowel (24pcs)</p>
<p>S</p>  <p>4mm</p>	<p>T</p> 	<p>U</p>  <p>ø6x30mm</p>
<p>Allen key (1pc)</p>	<p>Anti fall hardware (1set)</p>	<p>Wood dowel (20pcs)</p>

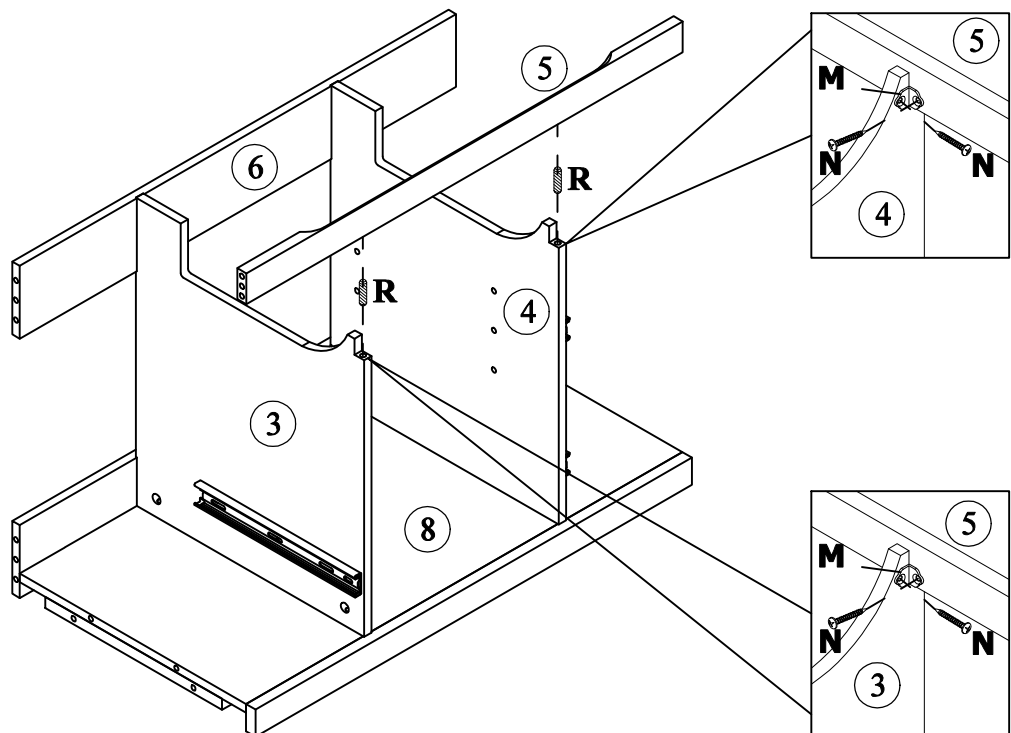
STEP: 3

D		R		E	
3PCS		2PCS		4PCS	


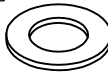

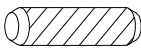


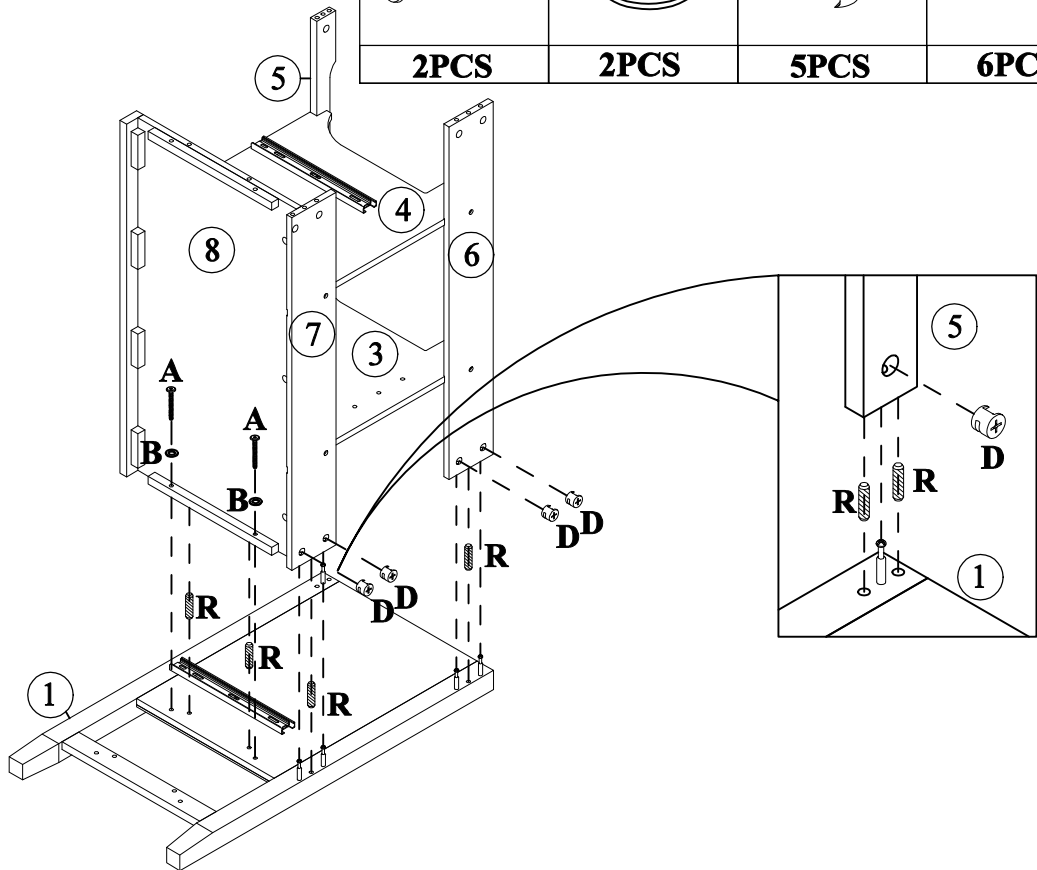
STEP: 4

M		N		R	
2PCS		4PCS		2PCS	



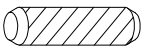


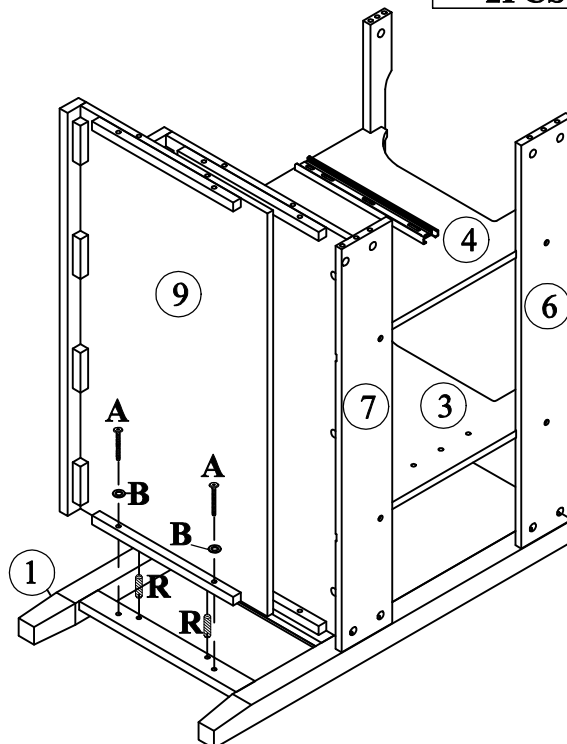
STEP: 5

A	B	D	R
			
2PCS	2PCS	5PCS	6PCS




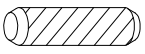


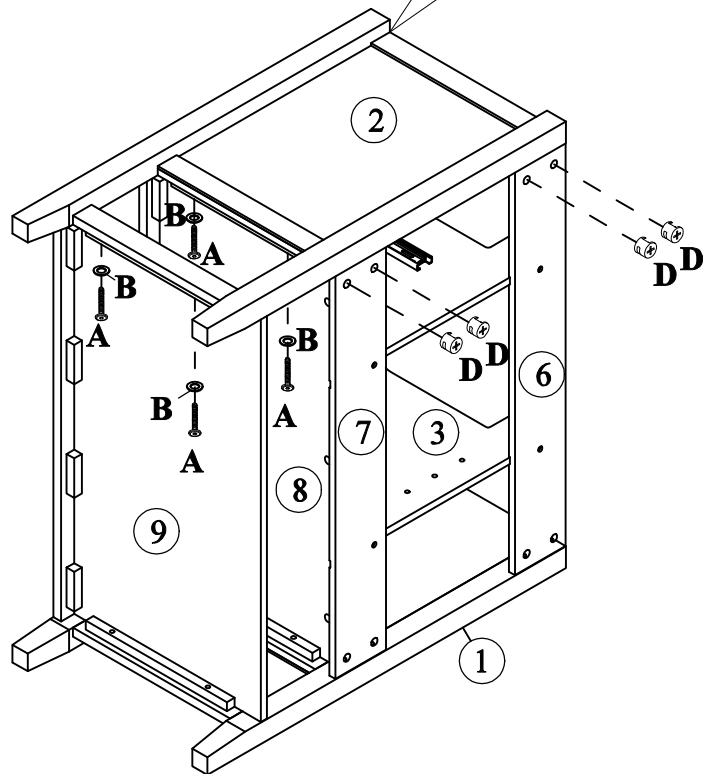
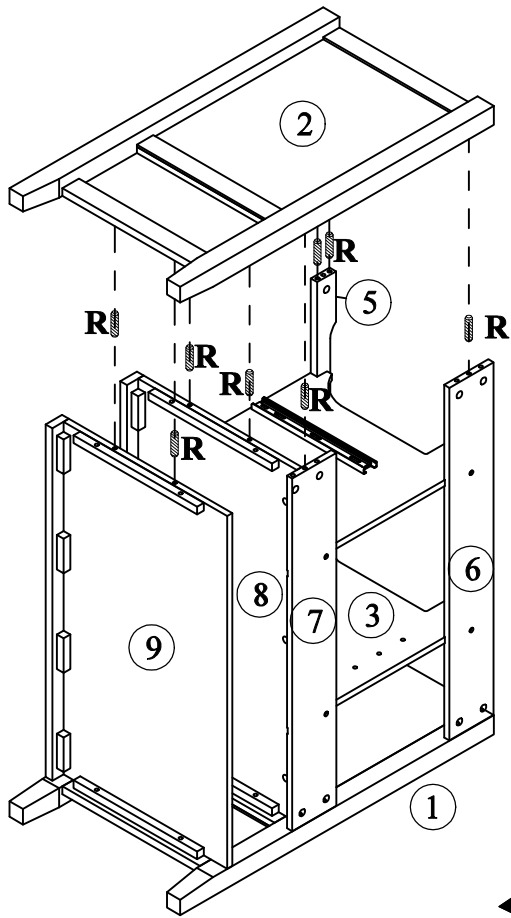
STEP: 6

A	B	R
		
2PCS	2PCS	2PCS





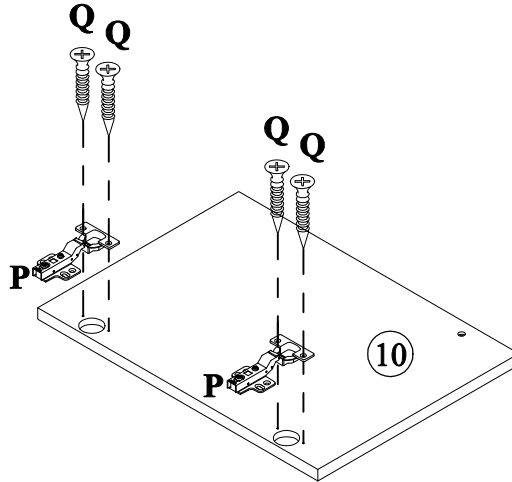
STEP: 7

A	B	D	R
			
4PCS	4PCS	5PCS	8PCS


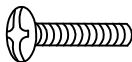



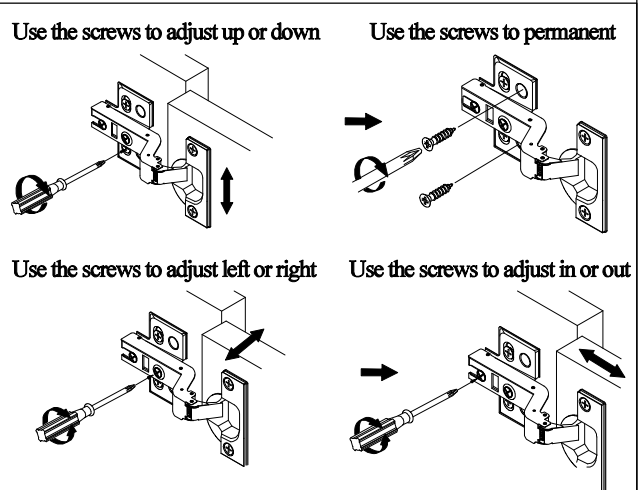
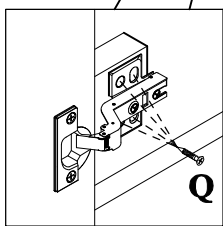
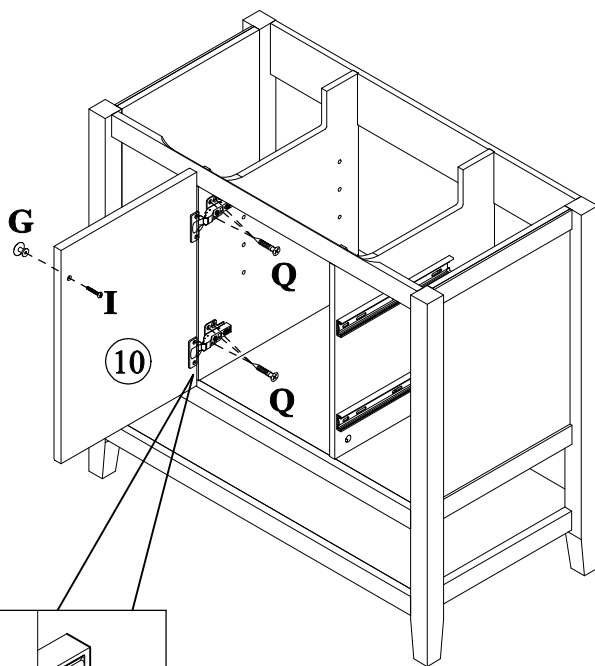
STEP: 8

P	Q
	
2PCS	4PCS



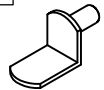
STEP: 9

G	I	Q
		
1PC	1PC	8PCS

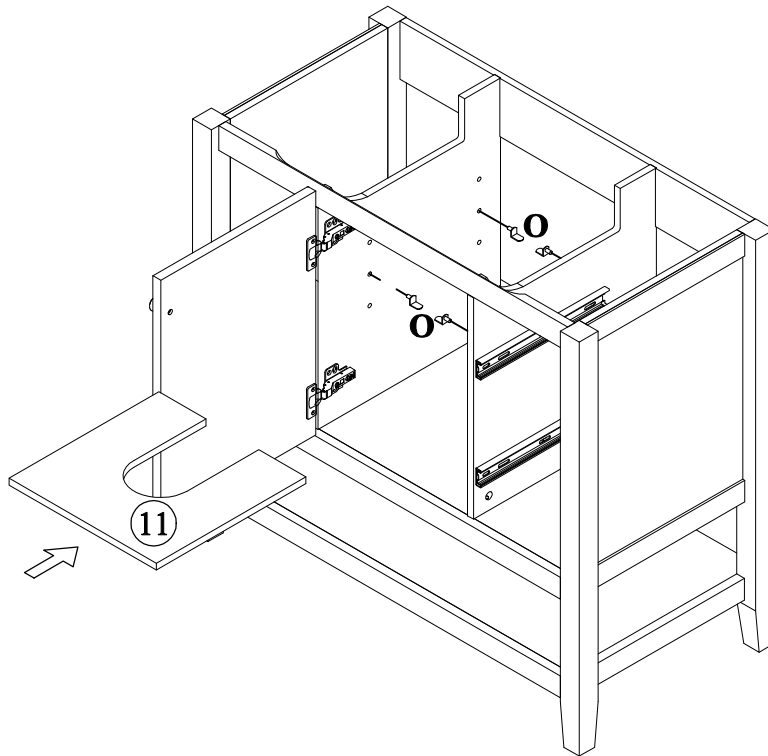


STEP: 10


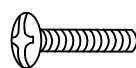
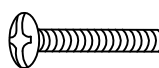
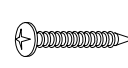
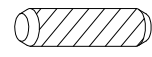
O

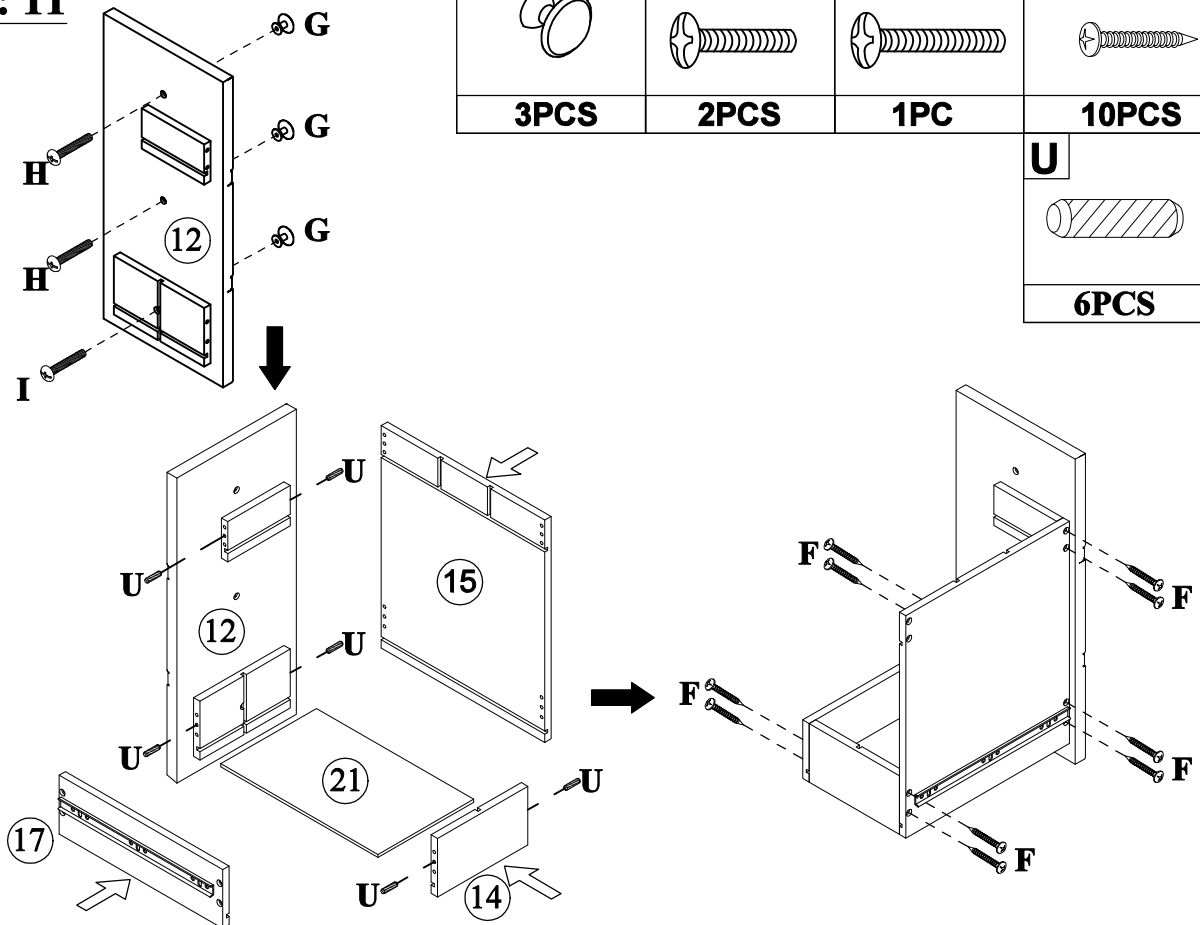


4PCS


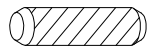


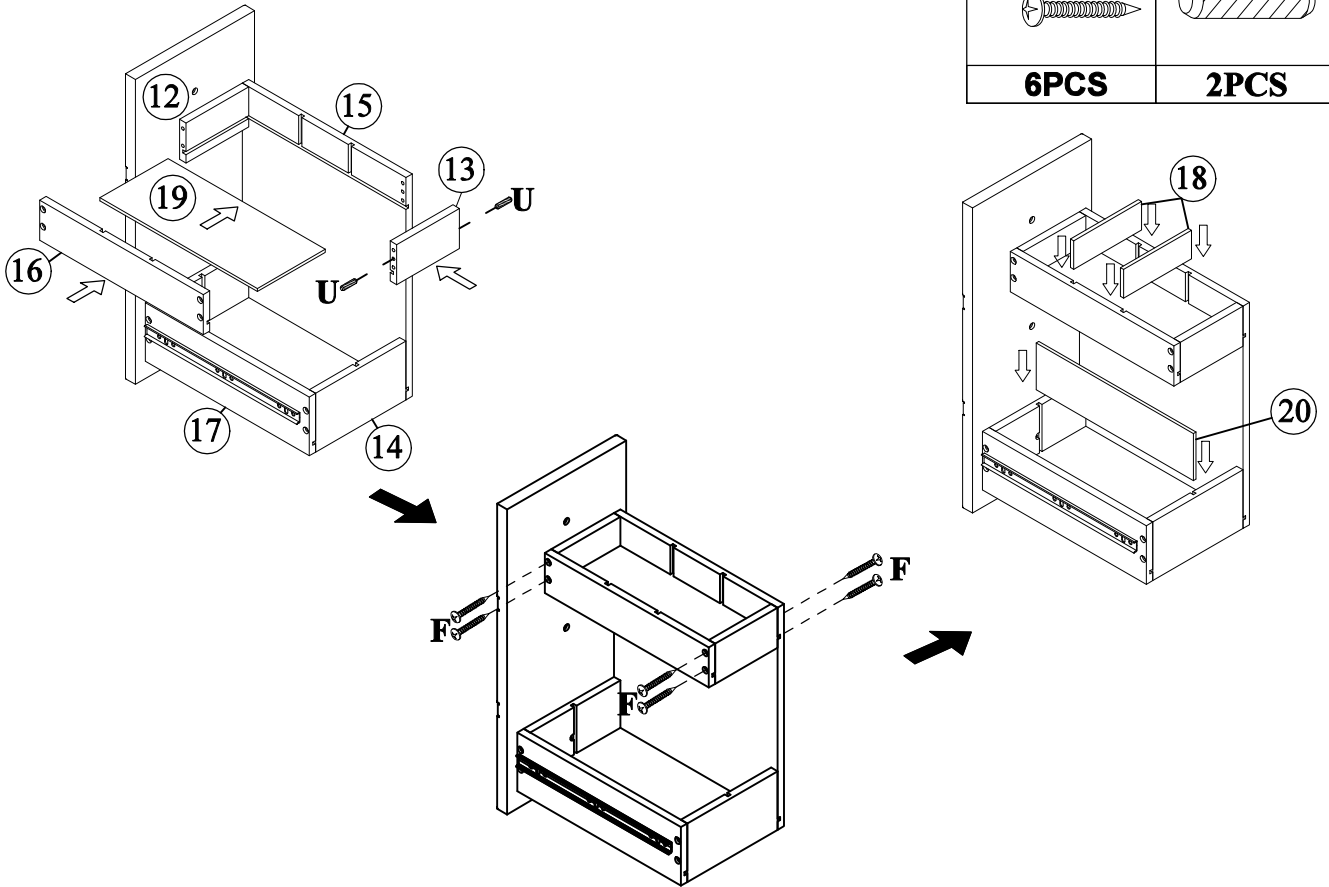
STEP: 11

G		H		I		F	
3PCS		2PCS		1PC		10PCS	
							U
							
							6PCS


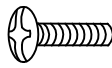
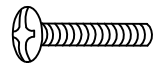

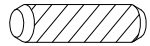


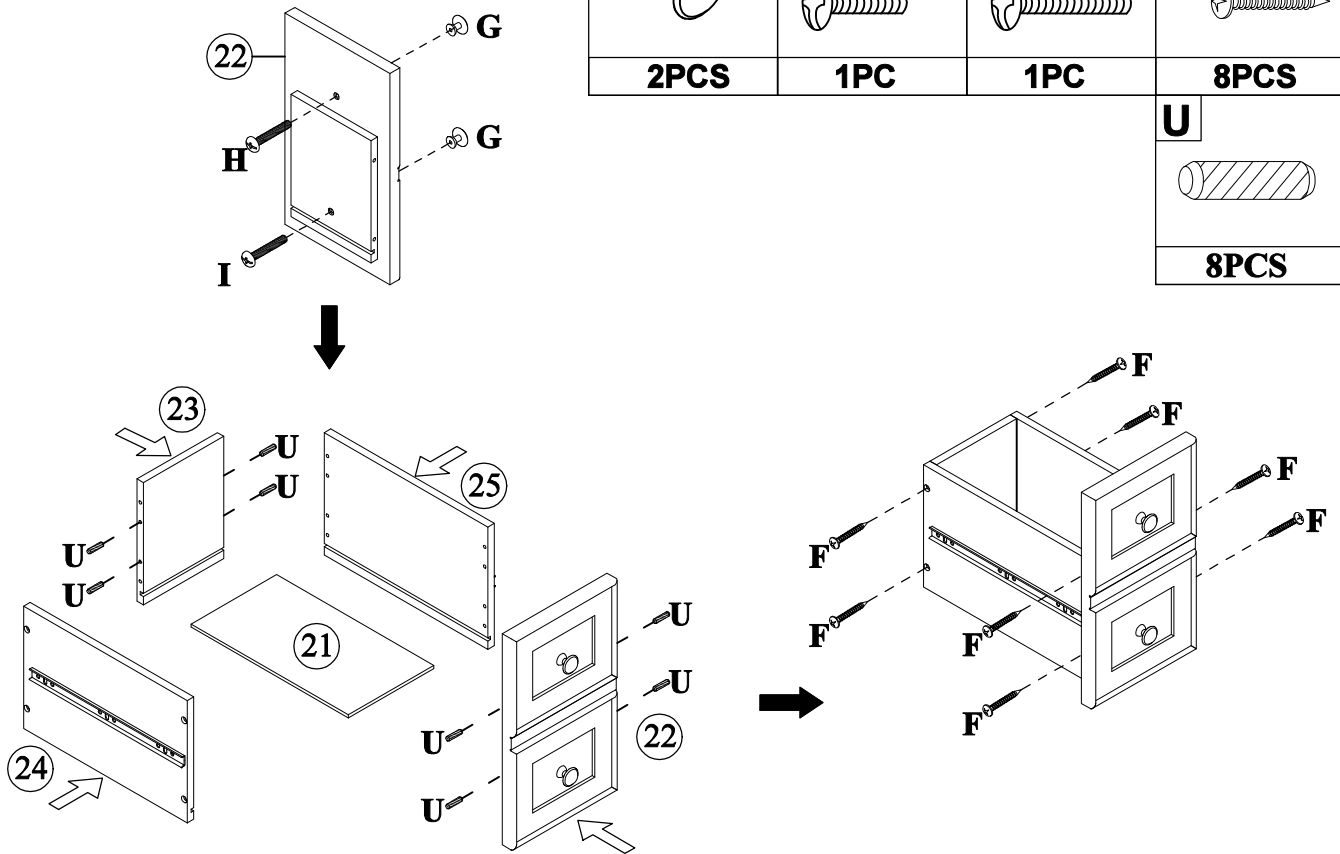
STEP: 12

F	U
	
6PCS	2PCS


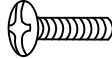

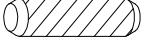


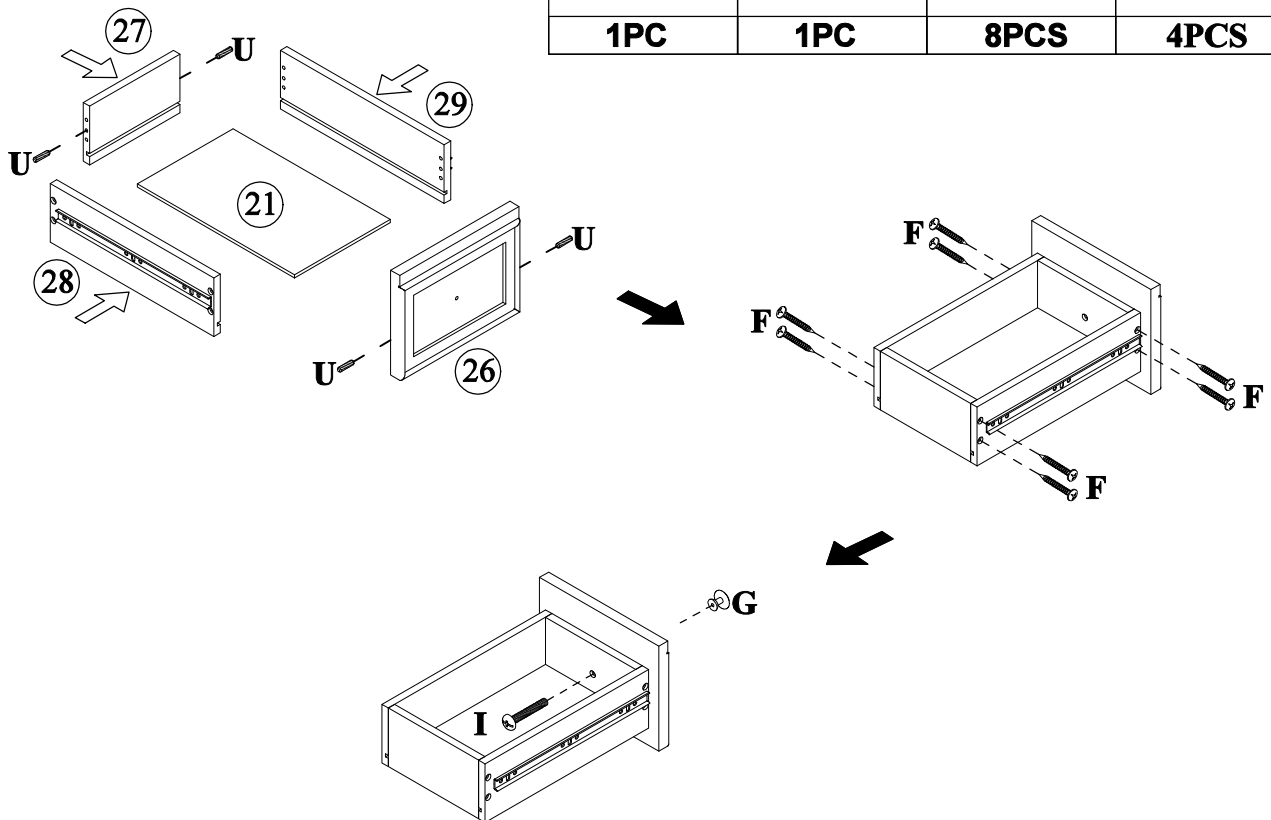
STEP: 13

G	H	I	F
			
2PCS	1PC	1PC	8PCS
			U
			
			8PCS

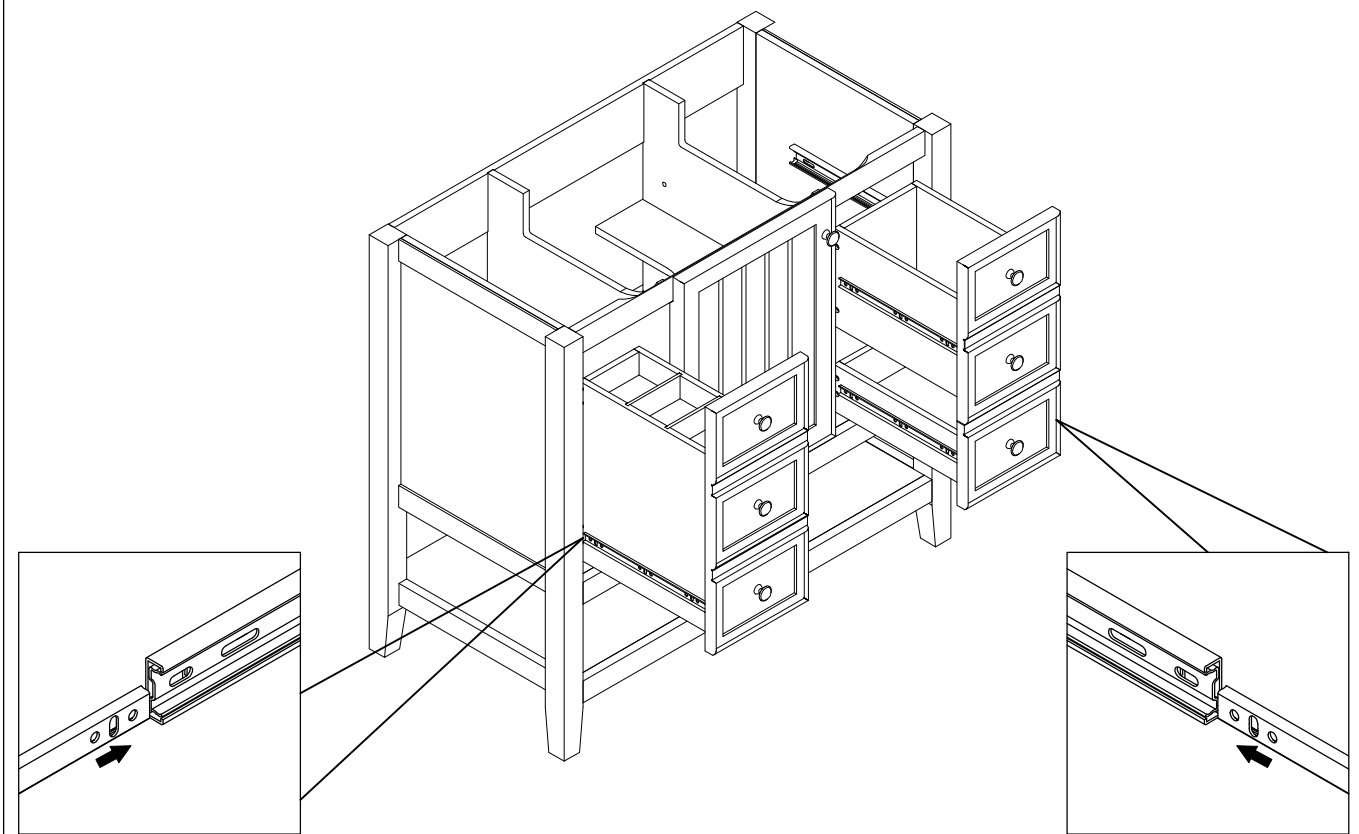


STEP: 14

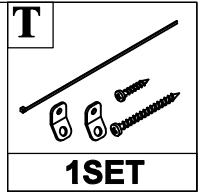
G 	I 	F 	U 
1PC	1PC	8PCS	4PCS



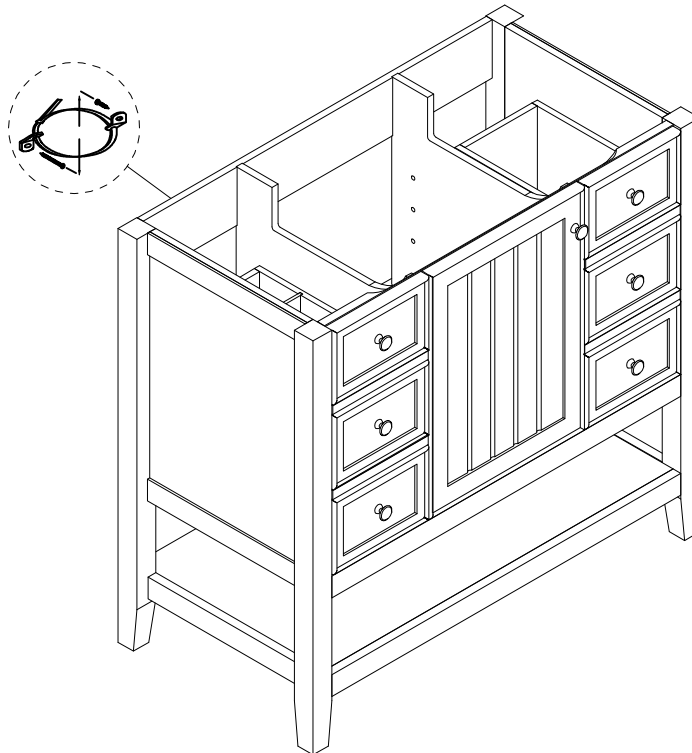
STEP: 15



STEP: 16

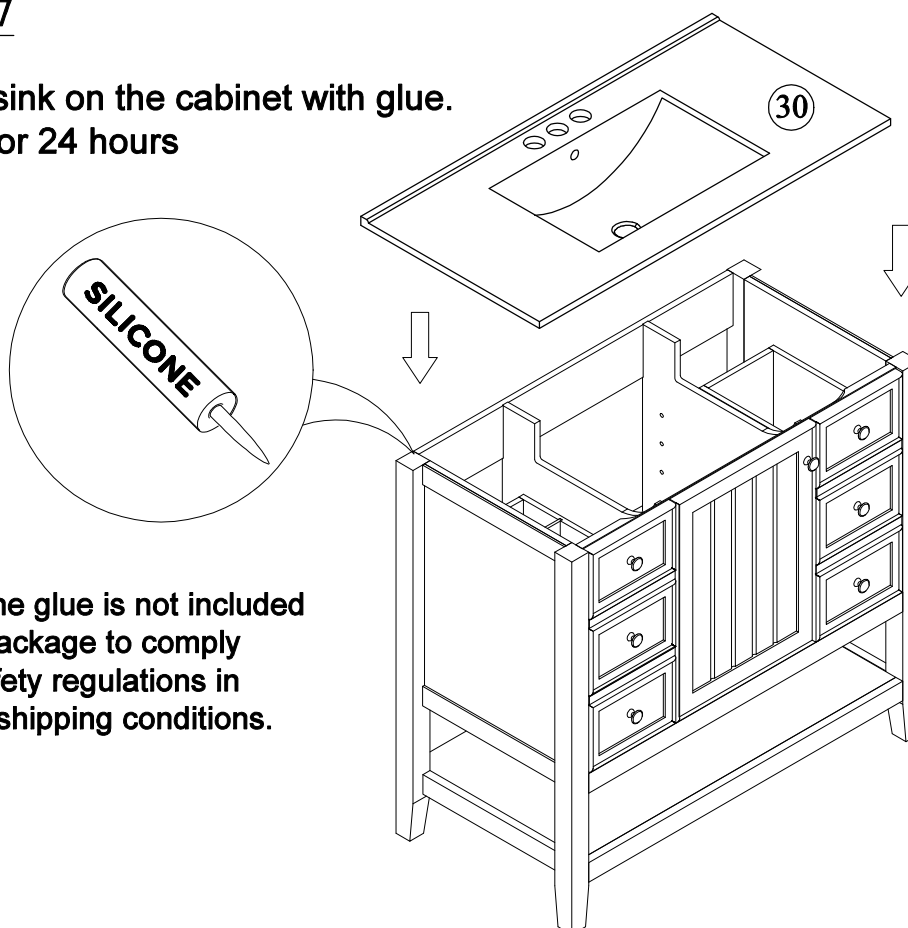


Wall



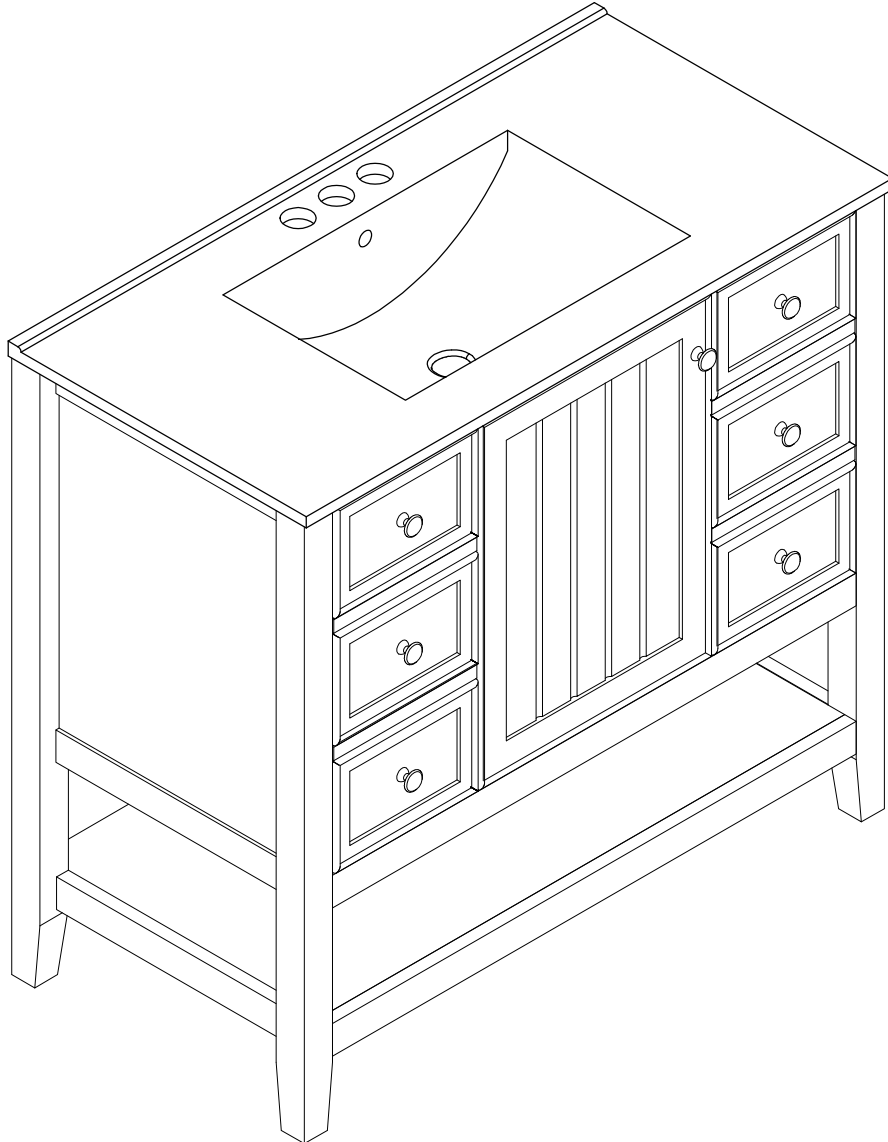
STEP: 17

Install the sink on the cabinet with glue.
Let stand for 24 hours

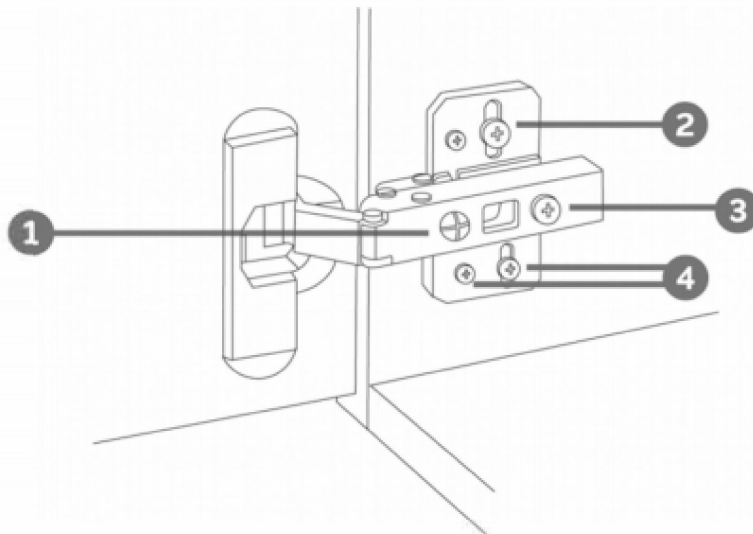


*Silicone glue is not included
in the package to comply
with safety regulations in
certain shipping conditions.

STEP: 18

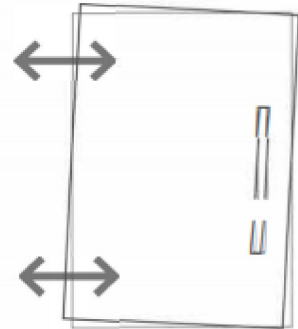


HINGE ADJUSTMENTS



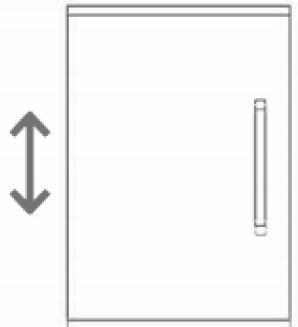
1 Sideways / Tilt adjustment

Turn the screw
clockwise to move the door further away from
the side of the cabinet
anticlockwise to move the door closer to the
side of the cabinet



2 4 Height adjustment

While supporting the weight of the door, turn the
screws
clockwise to move the door up
anticlockwise to move the door down



3 Forward and back adjustment

If the gap between the back of the door and the
cabinet is too small, and the door may not close
fully. Turn the screw
clockwise to decrease the gap between the
door and the cabinet
anticlockwise to increase the gap between the
door and the cabinet

