



APEX Series

**USER GUIDE &
ASSEMBLY INSTRUCTIONS**

IT'S TIME TO UPGRADE YOUR CHAIR!

CHAIR PARTS

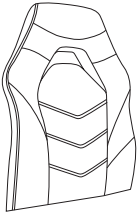

BACK x 1



CENTRAL BASE x 1

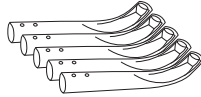

BASE x 5



GAS LIFT x 1

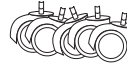

WHEEL x 5



SEAT x 1

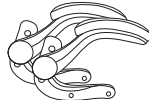

ARMREST x 2

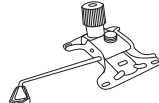

CONTROL MECHANISM x 1

HARDWARE

M6*25mm



A X8
(ARMREST)

M6*20mm



B X4
(TILTING)

M6*14mm



C X10
(BASE)



D X8
(BOLT CAP)



E X1
(ALLEN KEY)

We recommend keeping your **Allen key** for future maintenance.

STEP 1. BASE

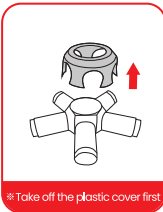

*Take off the plastic cover first

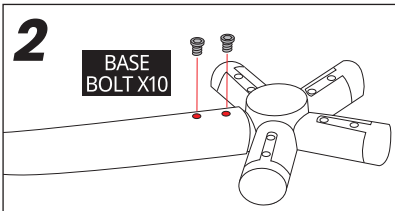
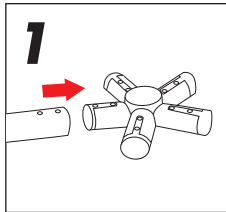

BASE BOLT X10

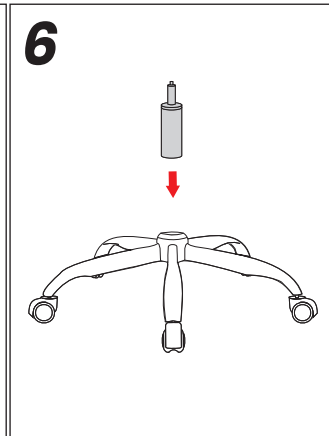
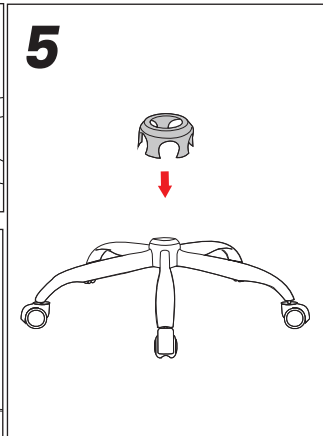
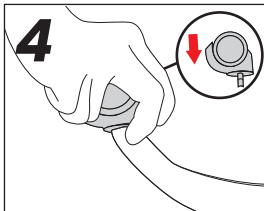
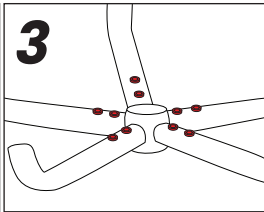

STEP 2. BODY

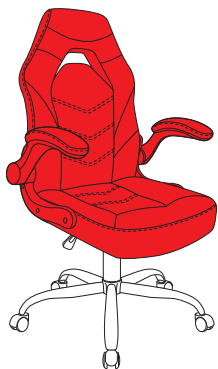

1

TILTING BOLTS X4

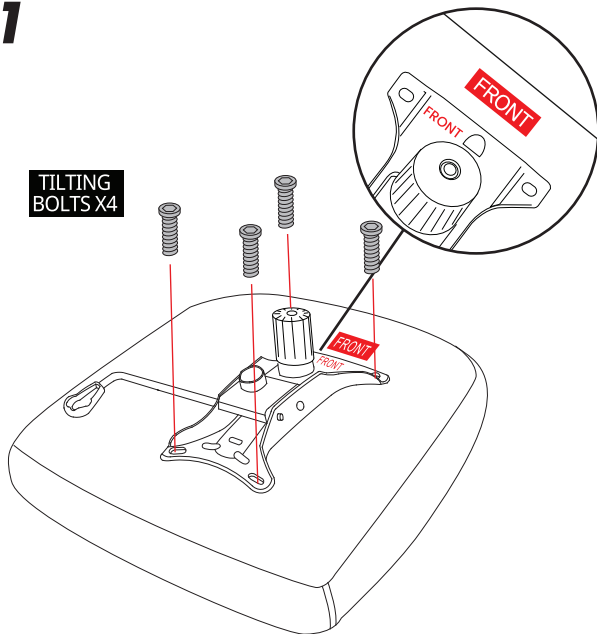

2

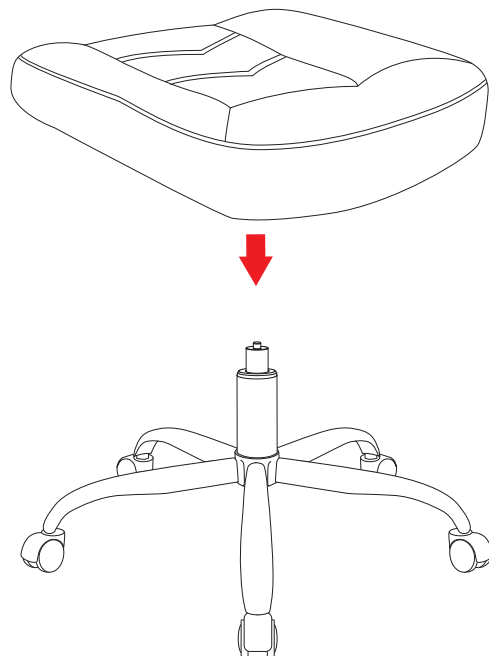

TILTING ASSEMBLY SEQUENCE

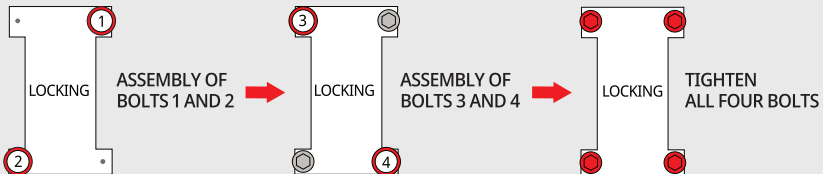

IMPORTANT NOTICE

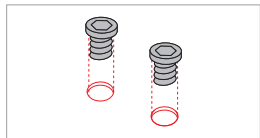

1 THE BOLT HOLES SHOULD BE ALIGNED

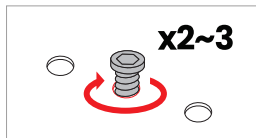

2 UNDER-TIGHTEN THE BOLTS

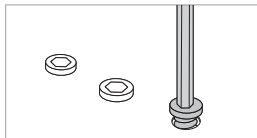

3 TIGHTEN ALL BOLTS

LOOSE BOLT ALERT!

When the bolts seem loose, detach the armrests and try inserting the bolts directly into their holes.

*Using an electric drill can damage the chair. Please re-tighten bolts manually.



3

LEFT

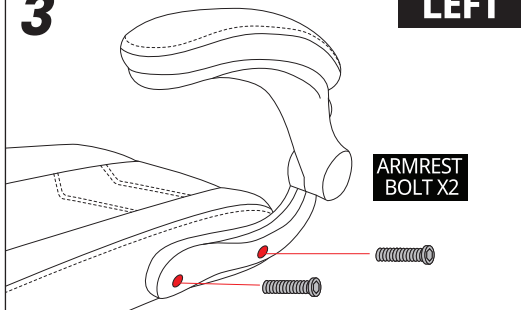

4

RIGHT

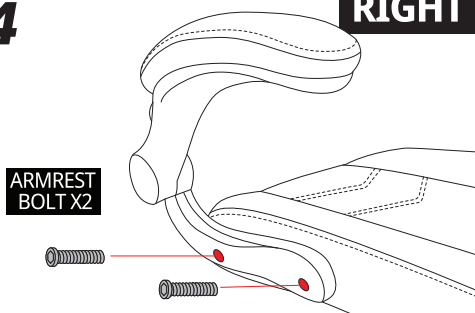

5

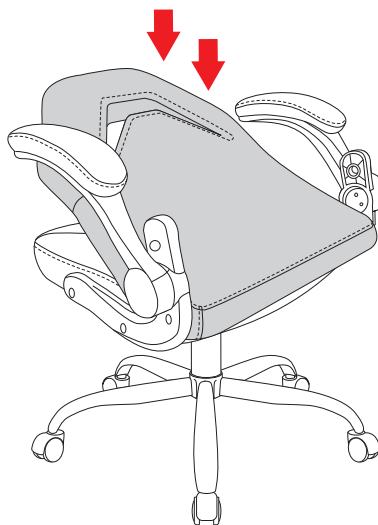

6

LEFT

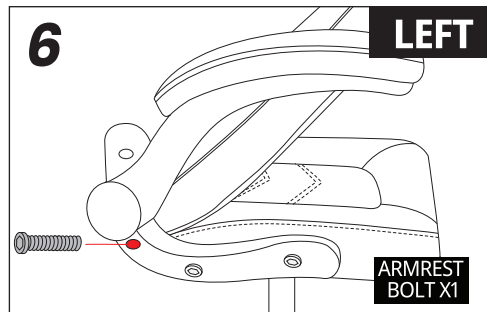

7

RIGHT

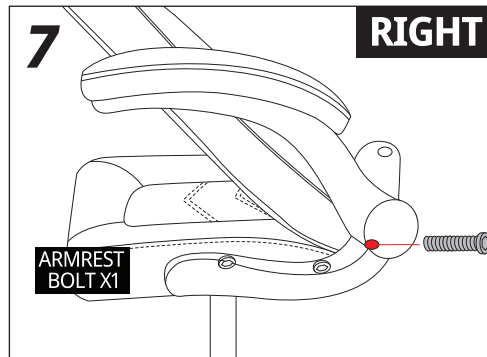

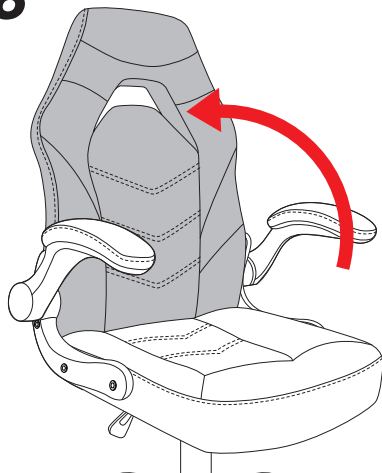
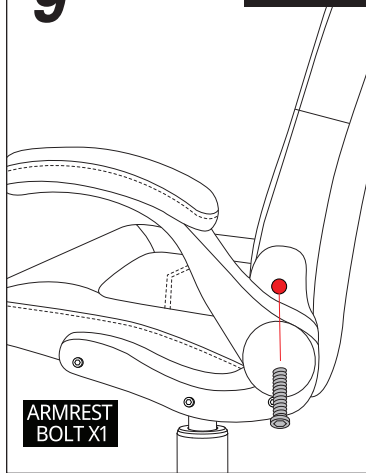
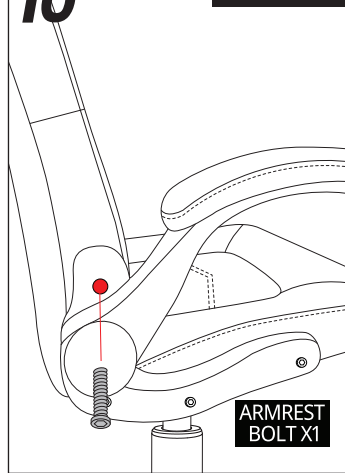
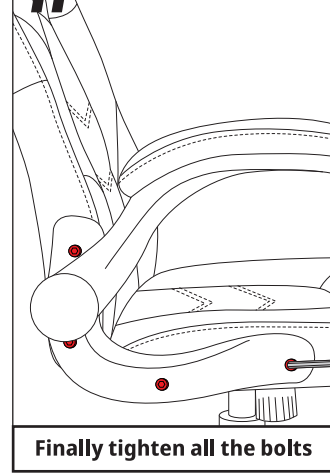
8**9****LEFT****10****RIGHT****11**

SAFETY INFORMATION



This product is designed for **one person** to sit at a time.



DO NOT use the chair unless all bolts, screws and knobs are tight



DO NOT use the chair if any of the components is missing or damaged.



DO NOT stand on the chair as a step stool or a ladder.



DO NOT tilt the chair forward, left, or right while sitting.



Be careful **NOT TO FALL** off from the chair.



Be careful, as some parts may be **sharp and heavy**.



Regularly check and tighten all bolts, screws, and knobs.



Failure to follow these warnings may cause **serious injuries**.



Be careful **not to hit** the furniture edges.



Keep in a **dry and cool** place.



When **moving** the object, proceed with **caution**.

OPTIONAL

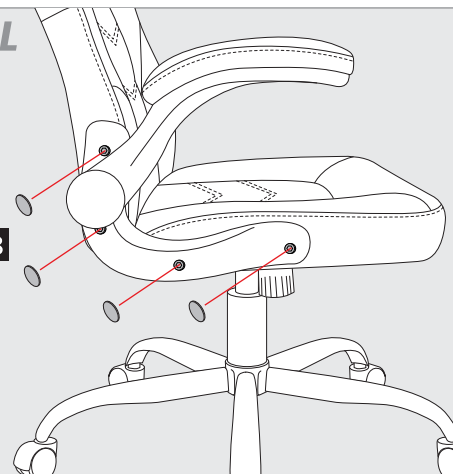
BOLT CAP X8

USER GUIDE

CHECK!!

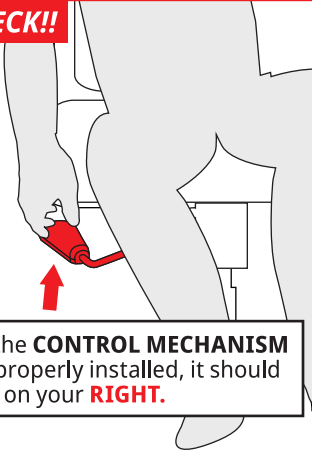

If the **CONTROL MECHANISM** is properly installed, it should be on your **RIGHT**.

HEIGHT ADJUSTMENT

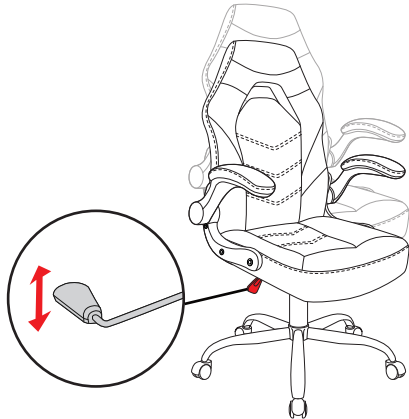

ADJUSTABLE FLIP-UP ARMRESTS

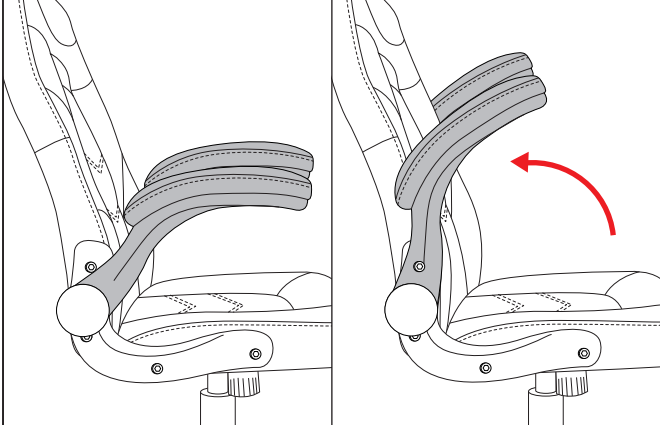

TILTING TENSION CONTROL

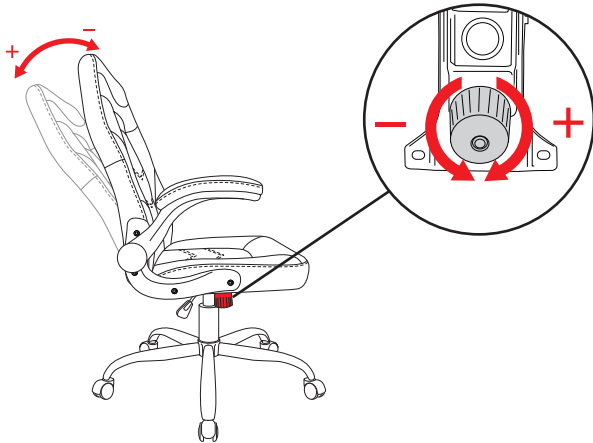

TILTING LOCK

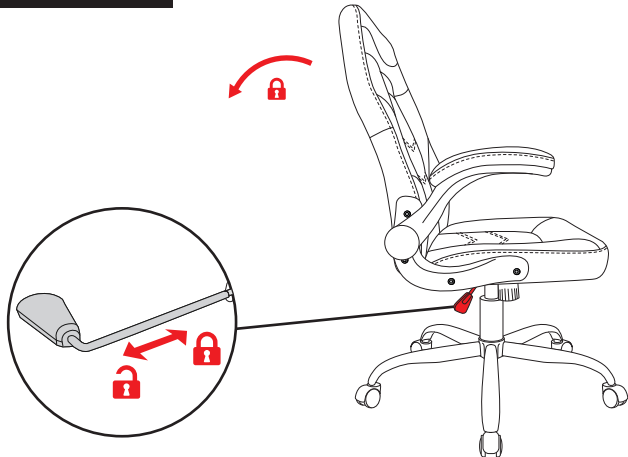



IMPORTANT SAFETY INSTRUCTIONS



Read these instructions carefully and retain them for future use. If this product is passed to a third party, then these instructions must be included.

When using the product, basic safety precautions should always be followed to reduce the risk of injury including the following:

- This product must be assembled by an adult.
- Keep children and pets away while assembling the product.
- Do not let children climb on or play with the product.
- Always use the product on a firm, level ground.
- Do not use this product if any parts are missing, damaged, or worn.
- To avoid scratching the floor, assemble the product on a soft surface, such as a carpet.
- Do not over-tighten the fasteners.
- Regularly examine the product for wear and tear. Stop using the product at the first sign of damage or if parts become detached.
- Do not use power tools to assemble the product.
Power tools may strip or damage the parts.
- Do not stand on the seat.
- Do not sit on the armrest.
- Keep all sharp objects away from the upholstery.
- Do not hang anything on the product.

2. Assembly

- For additional illustrated assembly steps, refer to the end of the written instructions.

3. Before First Use

- **Suffocation Hazard:** Packaging materials and small components such as screws, bolts, and other fasteners can pose a suffocation hazard. Always keep these parts out of reach of children and pets during assembly and ensure they are securely fastened to the product to prevent them from becoming loose over time.
- **Children's Safety:** Never leave children unattended with the chair. Teach children not to play with the chair, as it is not a toy. Climbing on the chair or playing with its moving parts can lead to falls or injuries. Additionally, ensure the chair is adjusted to a safe and appropriate height for children's use to prevent their feet from dangling, which can cause discomfort or pressure.
- **Pet Safety:** Be mindful of pets around your chair products. Pets, particularly those with a tendency to chew or claw, can damage the chair or even ingest small parts, leading to potential injury or health issues. Consider using protective covers or deterrents if your pets are known to chew on furniture.
- Remove all the packing materials.
- Review all components before assembly. Check the product for transport damages.

