

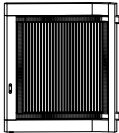

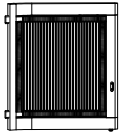

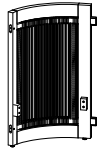

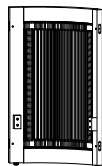

Hello! Please read these important attentions...

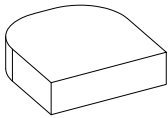
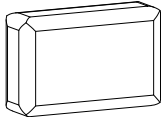
Please put a thick carpet on the ground to protect the furniture finish and corners. During the installation process, **DON' T** fasten screws tight 100% at a time.

ASSEMBLY INSTRUCTIONS

NUMBER	COMPONENT	QUANTITY
A	 <p>LEG FRAME 1</p>	1PC
B	 <p>LEG FRAME 2</p>	1PC
C	 <p>LEG FRAME 3</p>	1PC
D	 <p>LEG FRAME 4</p>	1PC
E	 <p>SEAT</p>	1PC
F	 <p>SEAT CUSHION</p>	1PC
G	 <p>BACK CUSHION</p>	1PC

ASSEMBLY INSTRUCTIONS

NUMBER	COMPONENT	QUANTITY
H	 SCREW M7x70MM	4PCS
I	 SCREW M6x40MM	2PCS
J	 SCREW M4x20MM	6PCS
K	 PLASTIC LID	4PCS
L	 M4	1PC

NOTE: The accessory pack does not include a screwdriver. Please prepare a screwdriver before you assemble.

ASSEMBLY INSTRUCTIONS

1

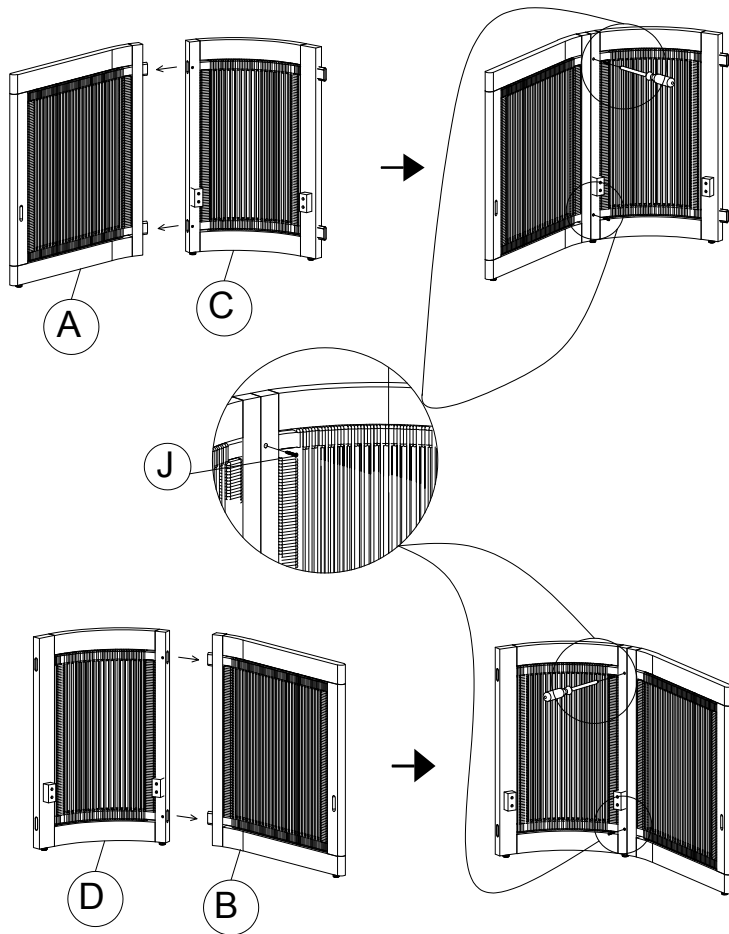

Use the Screws M4X20 MM (J) to connect with the Leg Frame 1 (A) and

Use the Screws M4X20 MM (J) to connect with the Leg Frame 2 (B) and Leg Frame 4 (D) them together to create the Left Leg Cluster.

ASSEMBLY INSTRUCTIONS

2

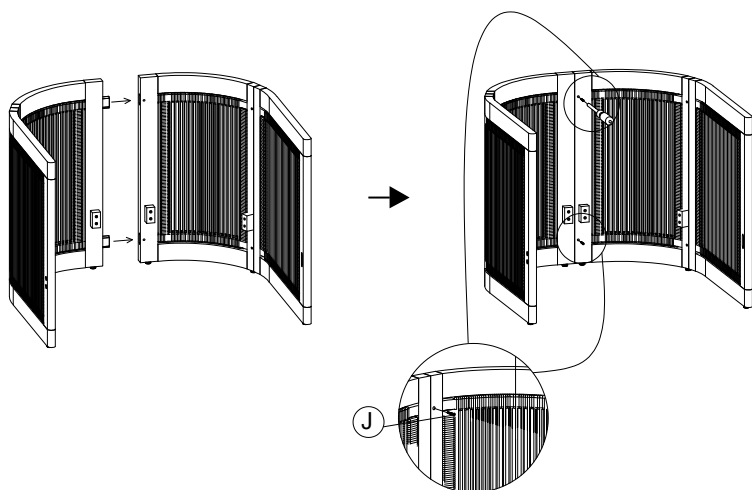

Use the Screws M4X20 MM (J) to connect with the 2 Right and Left Clusters to make the Leg Cluster.

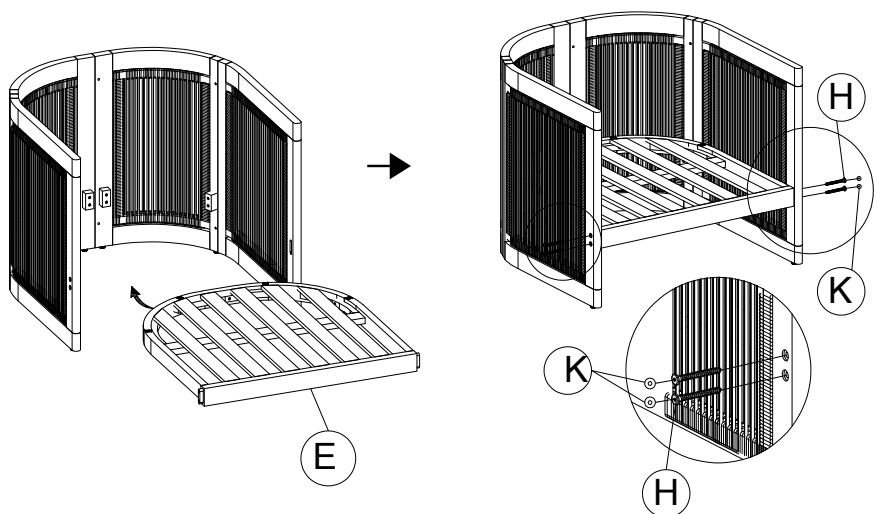

Use the Screws M7X70 MM (H) to connect with the leg Cluster with seat (E) them together.

ASSEMBLY INSTRUCTIONS

3

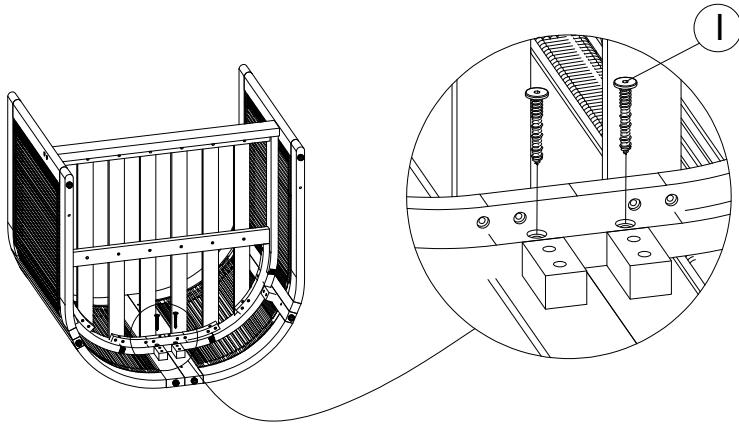

Use the Screws M6X40 MM (I) to connect with the Leg Cluster to the Seat them together.

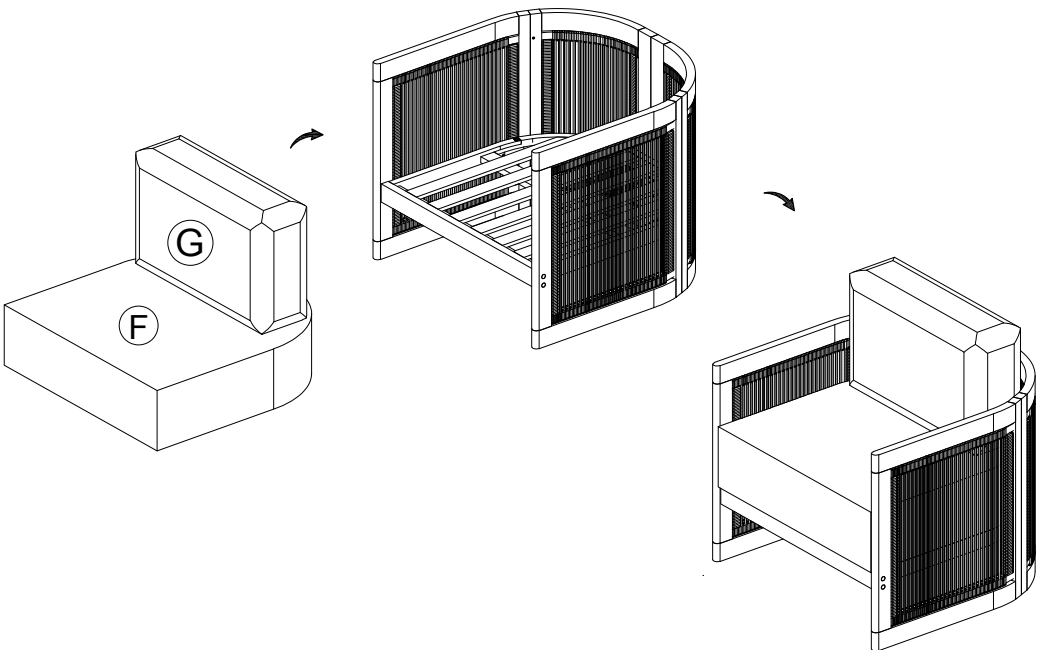

Put the Back and Seat Cushion on the Sofa.

ASSEMBLY INSTRUCTIONS

4

