

**EN\_IMPORTANT, RETAIN FOR FUTURE REFERENCE: READ CAREFULLY.**

**FR\_IMPORTANT: A LIRE ATTENTIVEMENT ET À CONSERVER POUR CONSULTATION  
ULTÉRIEURE.**







**ES\_IMPORTANTE, LEA Y GUARDE PARA FUTURAS REFERENCIAS.**

**PT\_IMPORTANTE, RETER PARA REFERÊNCIA FUTURA: LEIA ATENTAMENTE.**

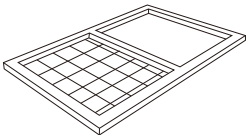
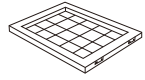
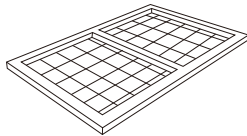
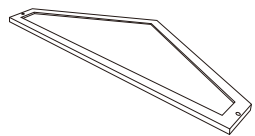
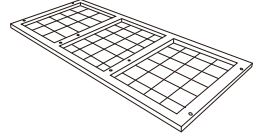
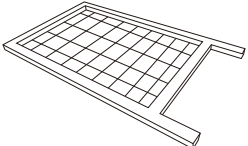

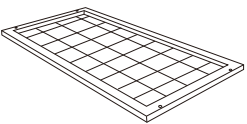
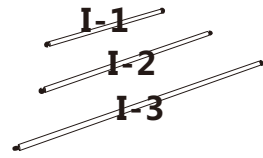
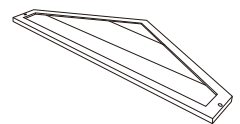
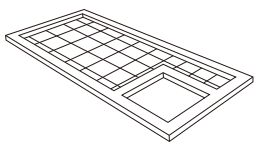
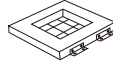
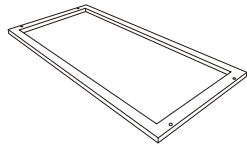

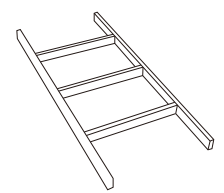
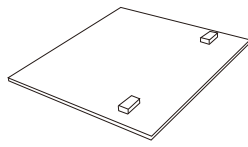
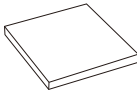
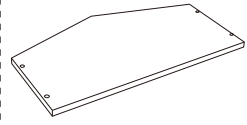
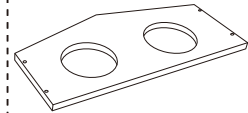
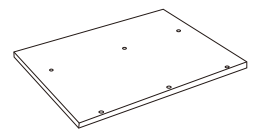
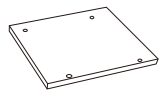
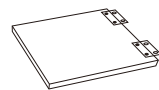
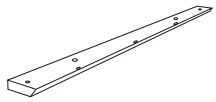
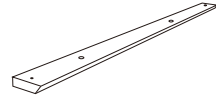

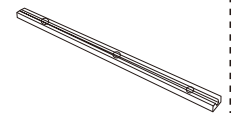

**DE\_WICHTIG! SORFGFÄLTIG LESEN UND FÜR SPÄTERES NACHSCHLAGEN AUFBEWAHREN.**

**IT\_IMPORTANTE! CONSERVARE IL PRESENTE MANUALE PER FUTURO RIFERIMENTO E  
LEggerlo ATTENTAMENTE.**

**PARTS**

					
<b>A</b>	<b>B</b>	<b>C</b>	<b>D</b>	<b>E</b>	
					
<b>F*2</b>	<b>G*2</b>	<b>H*4</b>	<b>I</b>	<b>J</b>	
					
<b>K</b>	<b>L</b>	<b>M</b>	<b>N</b>	<b>O</b>	
					
<b>P*2</b>	<b>Q*2</b>	<b>R</b>	<b>S</b>	<b>T</b>	
					
<b>U</b>	<b>V</b>	<b>W</b>	<b>X</b>	<b>Y*2</b>	<b>Z*4</b>

**HARDWARE**

			
3.5*30mm 32+3PCS	3.5*25mm 8PCS	3.5*20mm 4PCS	3.0*18mm 37+3PCS
<b>S1</b>	<b>S2</b>	<b>S3</b>	<b>S4</b>
			
2.5*10mm 40+4PCS	3PCS	3PCS	2pcs
<b>S5</b>	<b>S6</b>	<b>S7</b>	<b>S8</b>

**A** x01

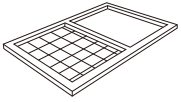

**B** x01

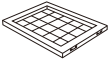

**S6** x01



**S7** x01



**S5** x12



2.5\*10mm

**S5\*2**

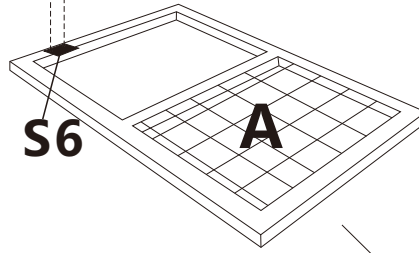

**S5\*2**

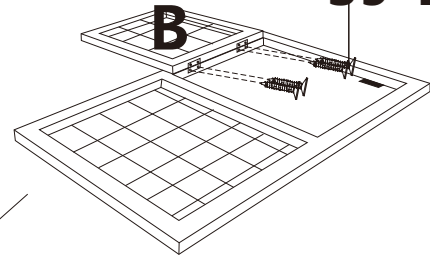

**S5\*6**

**S7**

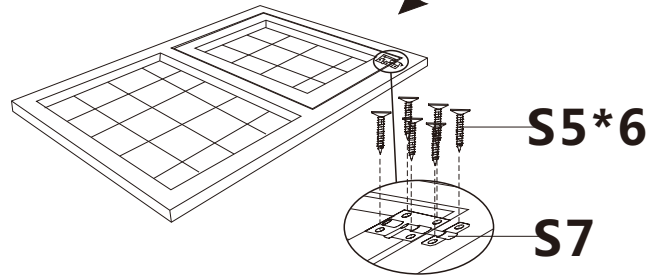

**01**

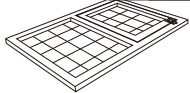

**C** x01

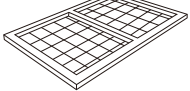

**D** x01



**S1** x02



3.5\*30mm

**S1\*2**

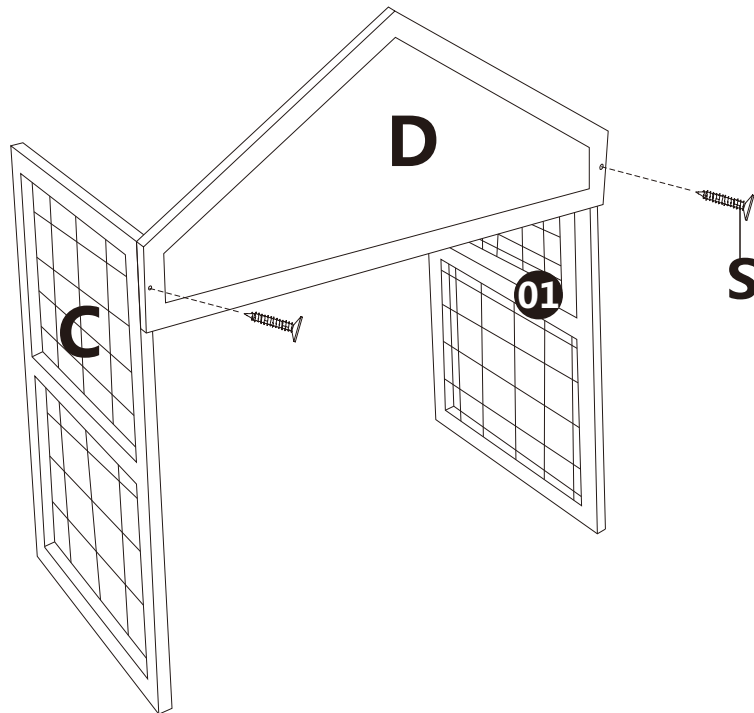

02



E x01

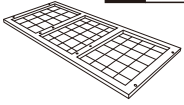

S1 x04



3.5\*30mm

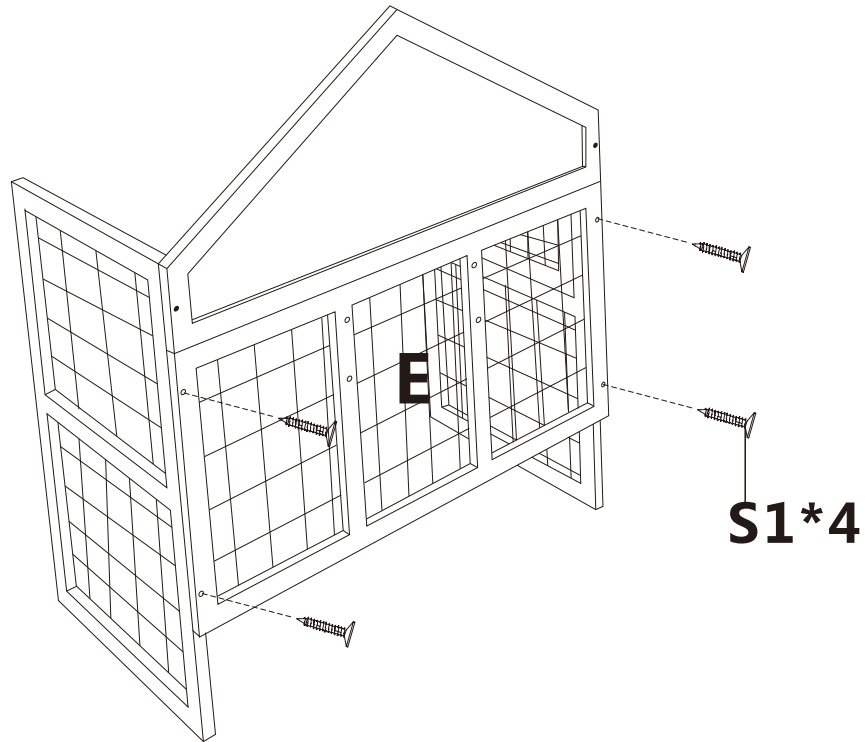

F x02

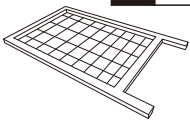

G x02



S2 x04



3.5\*25mm

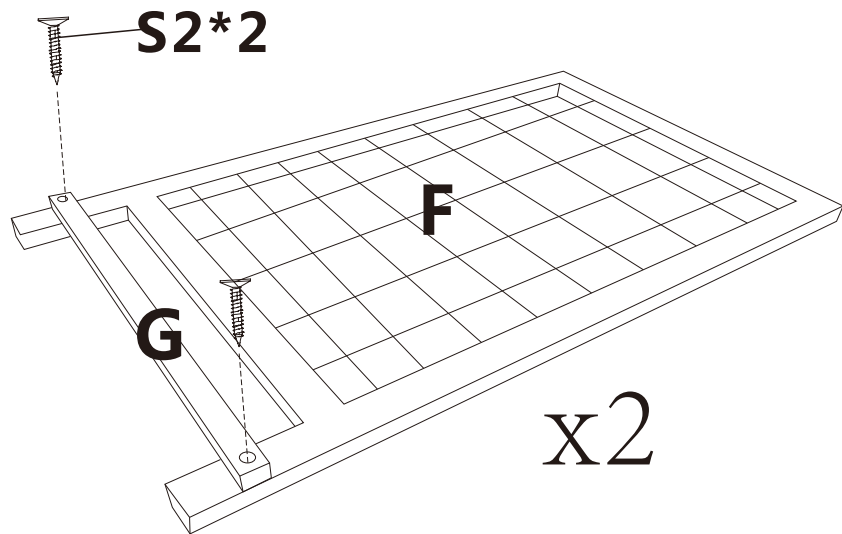

03



04

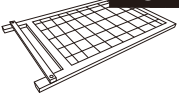

H x01

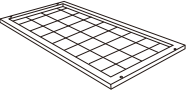

S1 x04



3.5\*30mm

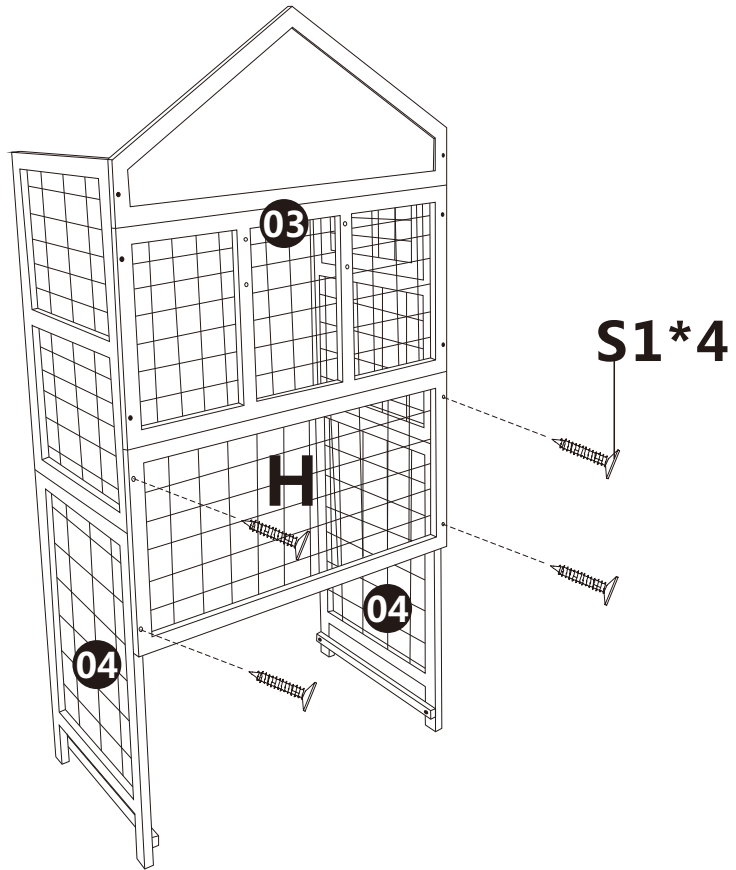

05



H x01

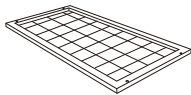

S1 x04



3.5\*30mm

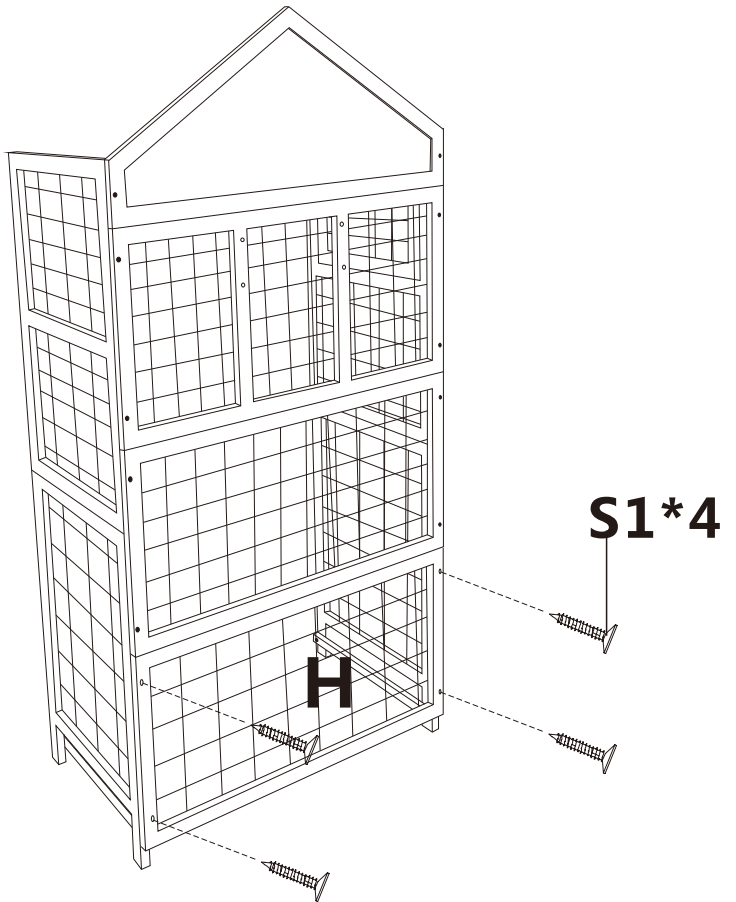

**Q** x02

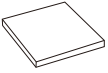

**R** x01



**S** x01



**T** x01

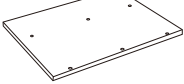

**S4** x14



3.0\*18mm

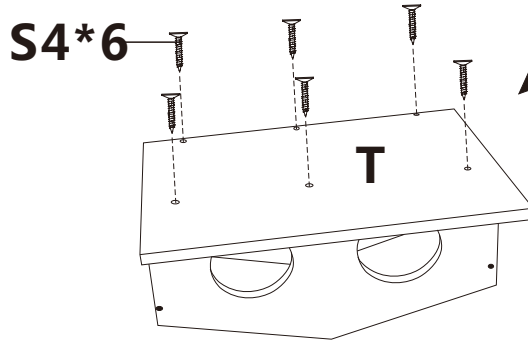
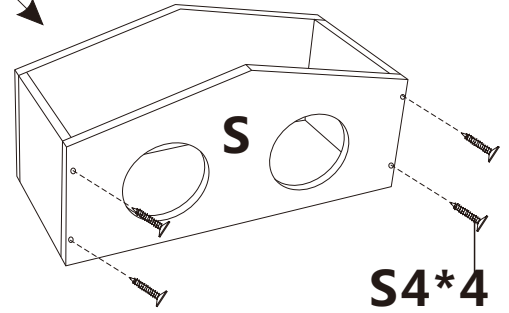
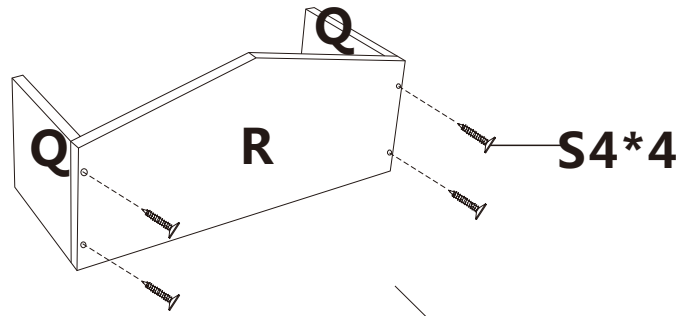

07

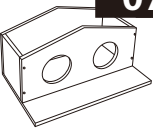

**U** x01

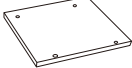

**V** x01

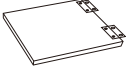

**S4** x04



3.0\*18mm

**S5** x04



2.5\*10mm

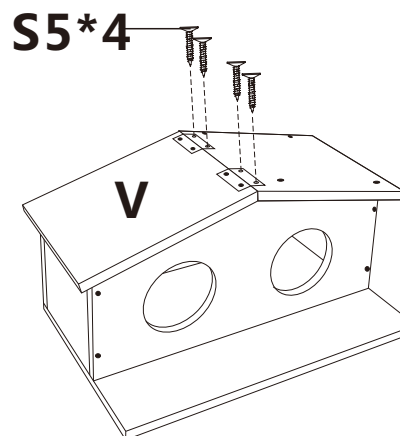
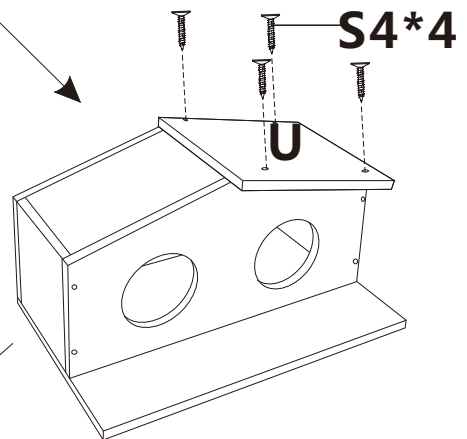
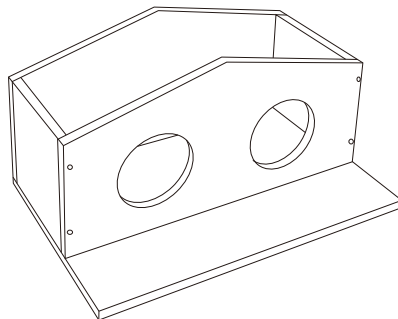

06



08

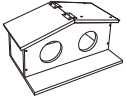

S1 x04



3.5\*30mm

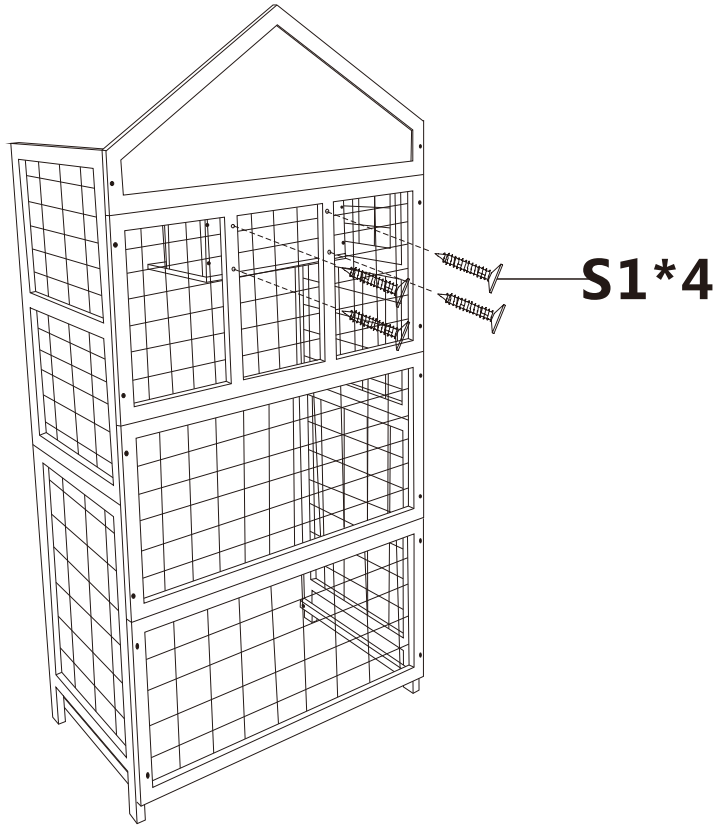

09



I x01

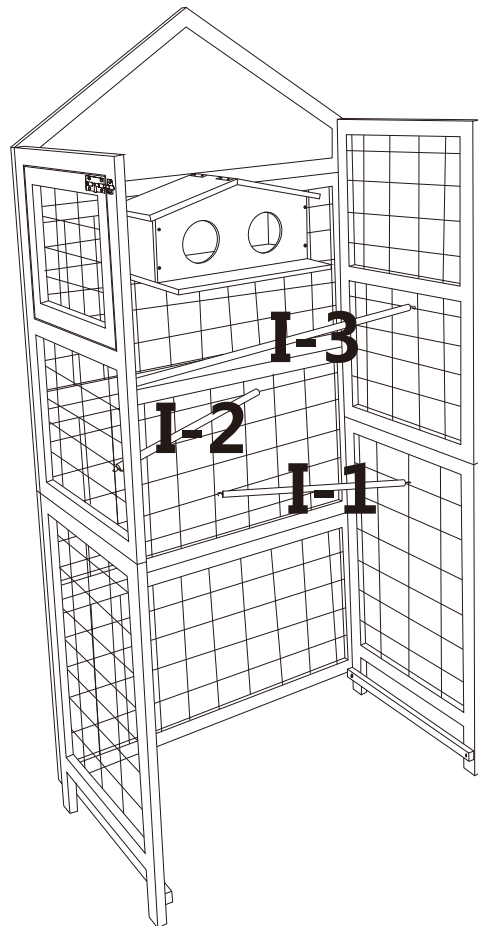
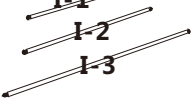



**J** x01



**S1** x02

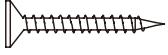

3.5\*30mm

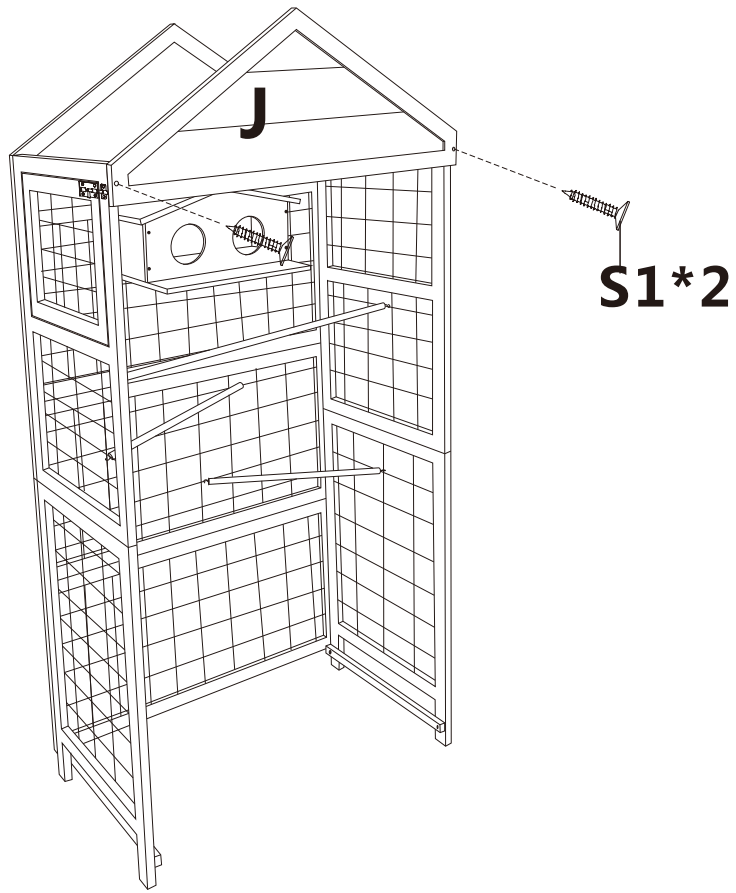

**H** x01

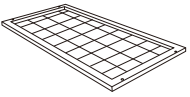

**S1** x04



3.5\*30mm

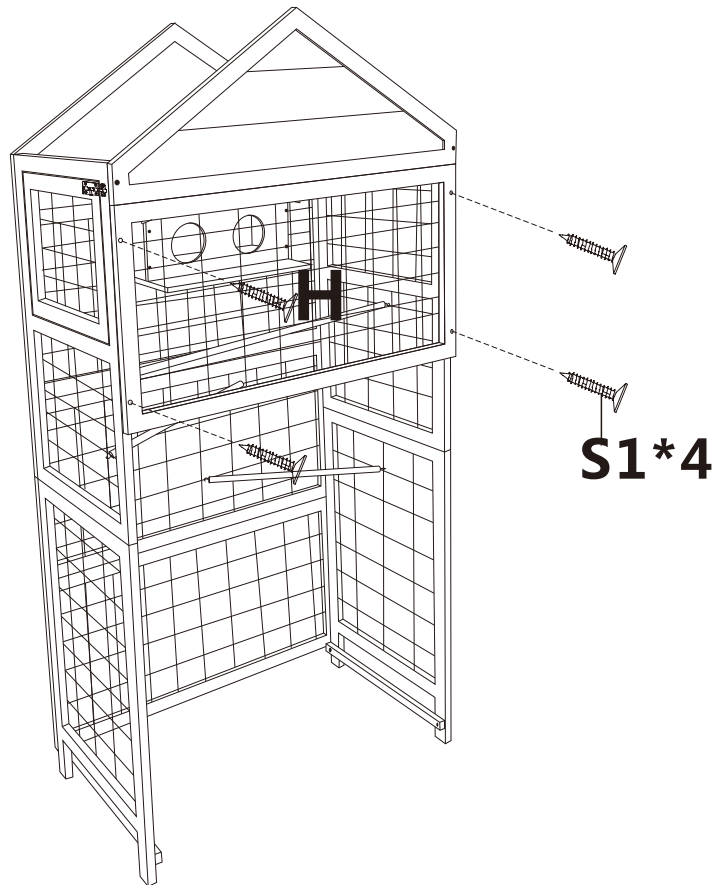

**K** x01

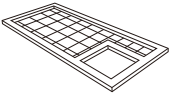

**L** x01



**S6** x01



**S7** x01



**S5** x12



2.5\*10mm

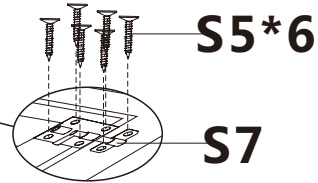
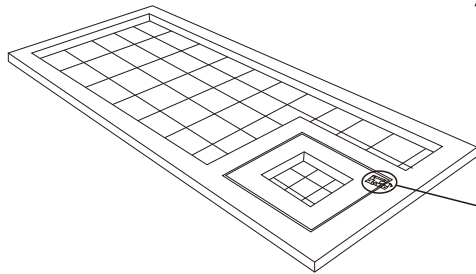
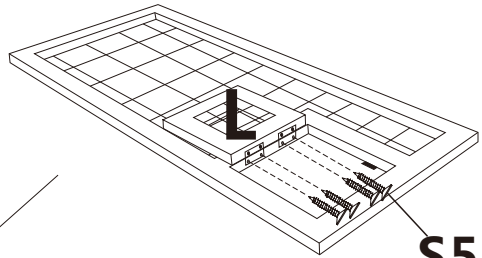
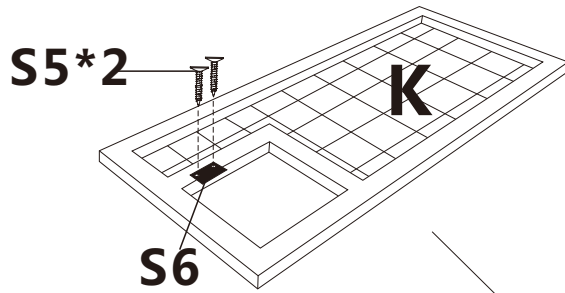

13

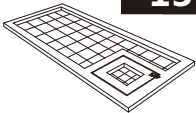

**M** x01

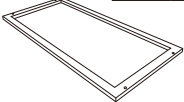

**S6** x01



**S7** x01



**S5** x12



2.5\*10mm

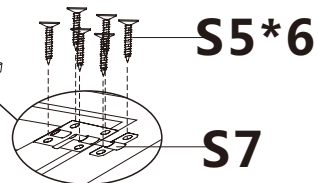
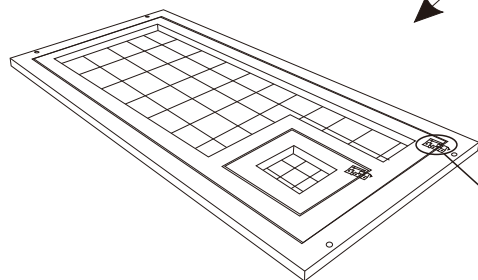
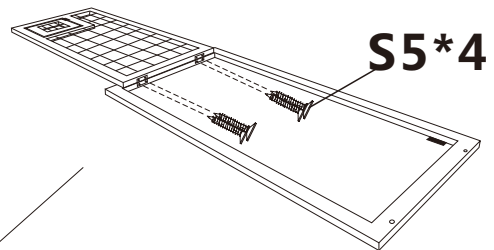
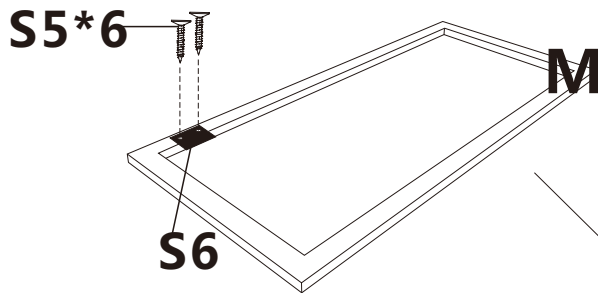

12



14

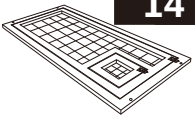

H x01

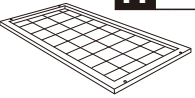

S1 x08



3.5\*30mm

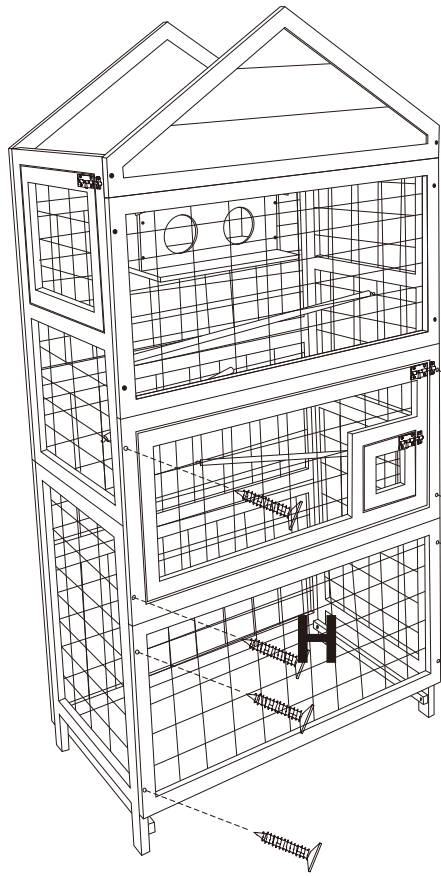

S1\*8

N x01



S8 x02

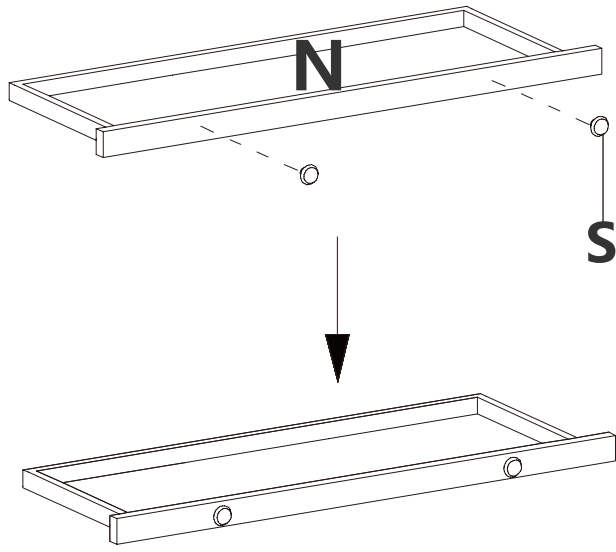

S8\*2



15



16



O x01

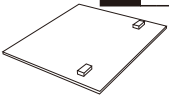

P x02



S2 x04

3.5\*25mm

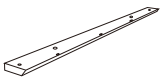
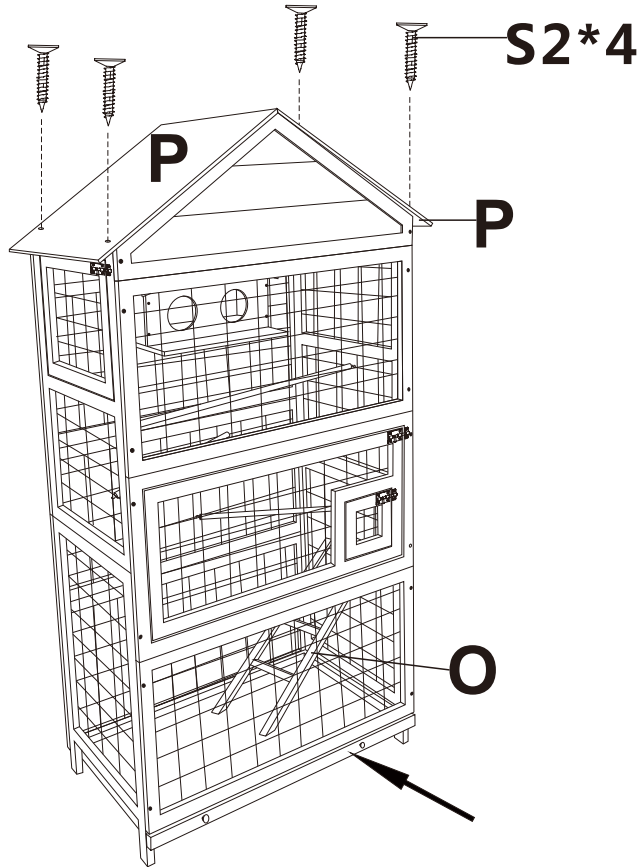

W x01

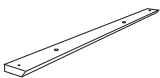

X x01



Y x02



S4 x07

3.0\*18mm

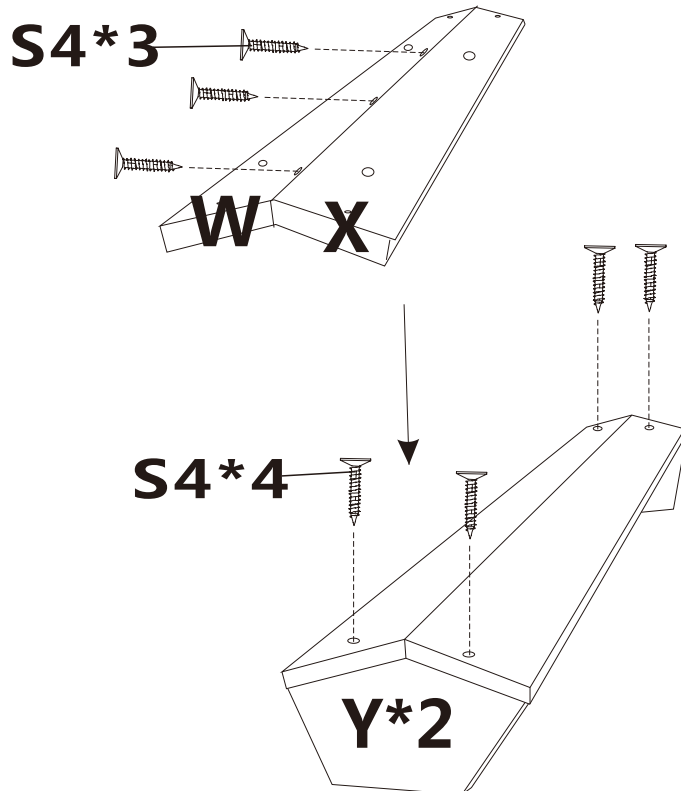



17

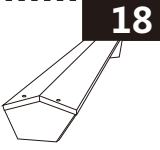

18

S3x04



3.5\*20mm

S3\*4

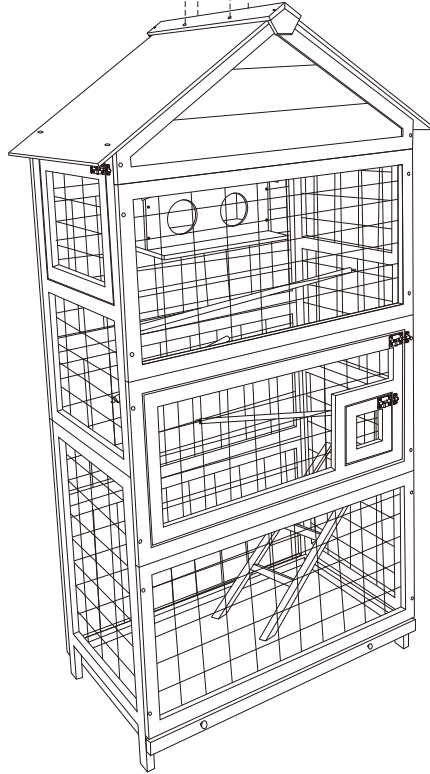

19

Z x04



S4x12



3.0\*18mm

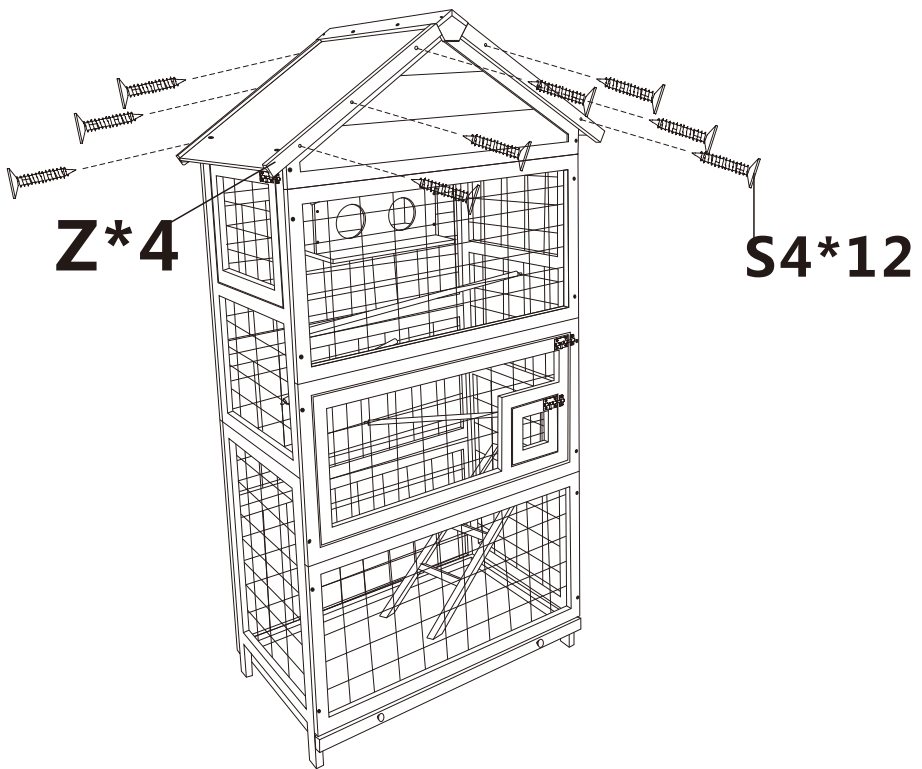

Z\*4

S4\*12