

ASSEMBLY INSTRUCTION

PART LIST:

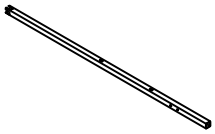

A:LSF Headboard Post
x 1pc

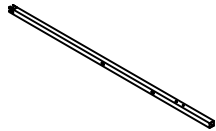

B: RSF Headboard Post
x 1pc

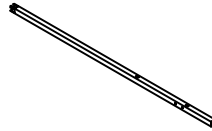

C:LSF Footboard Post
x 1pc

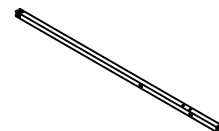

D:RSF Footboard Post
x 1pc



E:Short Upper Support Bar
x 2pcs

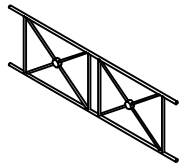

F: Headboard & Footboard Frame
x 2pcs

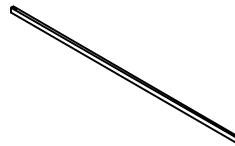

G:Long Upper Support Bar
x 2pcs



H:Rail
x 2pcs

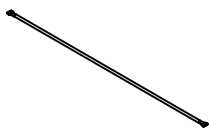

I:Slat with Connectors
x 16pcs

HARDWARE LIST:



1: Bolt 1/4*16mm
x16pcs

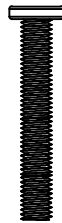

2: Bolt 1/4*60mm
x12pcs



3: Allen Key 4MM
x1pc

Note: Please do not tighten all bolts until the bed is assembled completely.

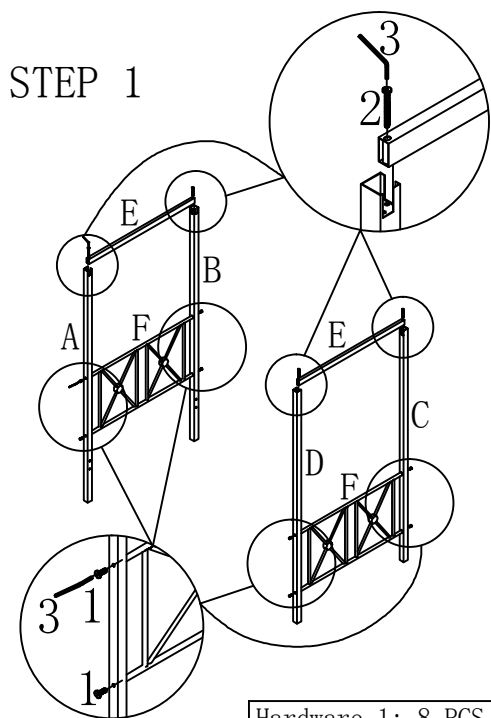

Hardware 1: 8 PCS
Hardware 2: 4 PCS

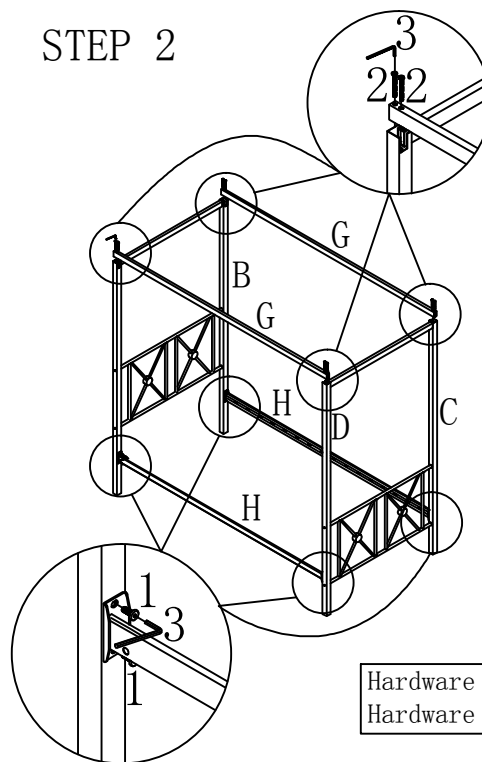

Hardware 1: 8 PCS
Hardware 2: 8 PCS

STEP 3

COMPLETED

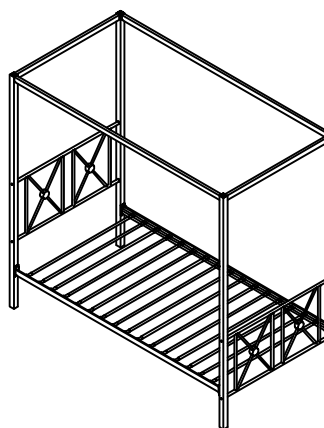
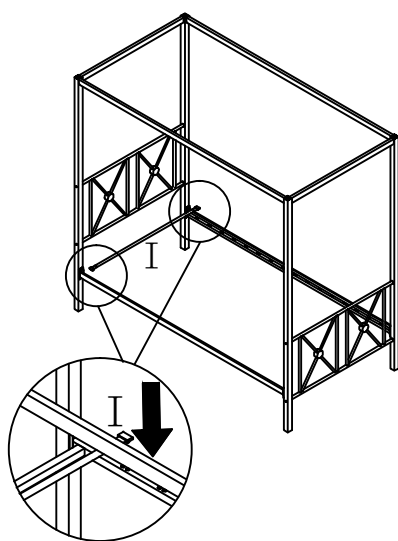

For items use on wooden floor, hard surfaces or carpets, it is recommended to install protective pads under all legs and supports to avoid/prevent from damages/scratches and discoloration.