













Parts & Hardware Included:

Picture	Description	Qty	Check list
	Terminal cap	3	A
	Ø110 hanging board	1	B
	M4*25 screws	2	C
	Ø120*25 wall lamp holder	1	D
	M5 flower branch nuts	2	E
	Ø10 bend	1	F
	Ø12*12 wire locking iron	2	G
	M5*35 flat head screws	2	H
	Ø55*20 Secondary pallet	1	I
	Ø30*50 light cup	1	J
	E12 card type full tooth lamp holder	1	K
	Ø145*130 iron wire light holder	1	L
	210mm long grape crystal string	16	M

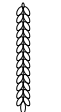
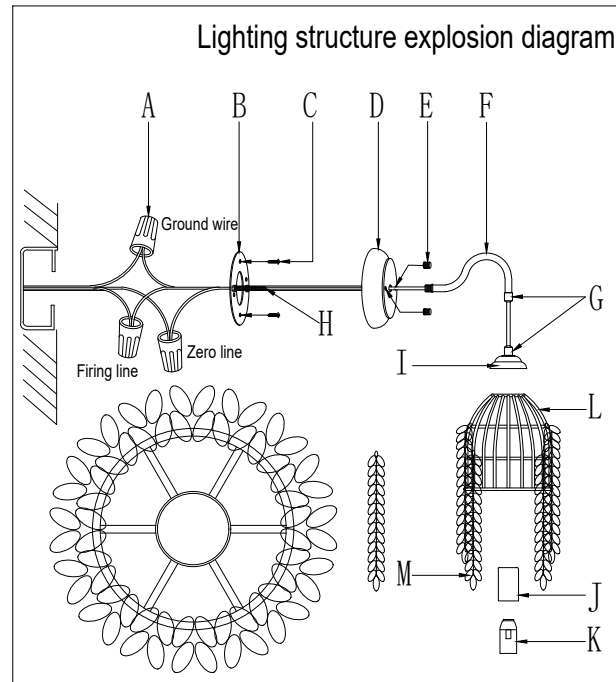
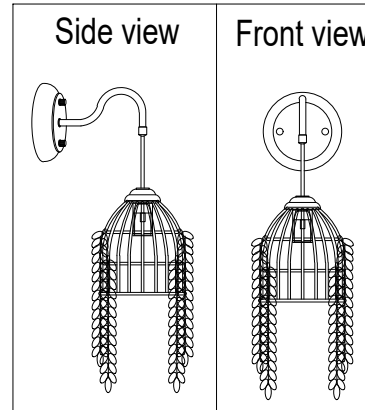
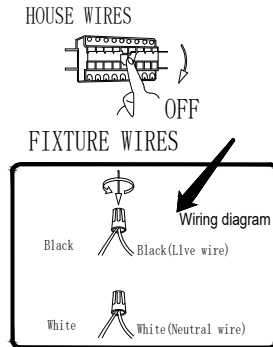

Installation procedure

Installation Procedure Only indoor installation

1. Carefully disassemble and identify each part to make sure you have everything ready for installation

Place each part on a clean flat surface, such as a table or floor.

2. Cut off the main power supply to the fuse box or circuit breaker in the house or building.

3. Unscrew the M4 and remove the mounting support.

4. Secure the mounting bracket to the socket box using 8/32 screws.

5. Use a Phillips screwdriver (not provided) to remove the M4 screws from the support.

6. Connect wires from the jig to the power cord from the outlet box and cover with wires.

Screw the neutral wire on the light fixture and the neutral wire on the outlet box together and cover it with a wire cap.

Screw the firewire on the lamp with the firewire on the socket box and cover it with a wire cap.

Remove the ground wires from the fixture and socket box and slip them under the head of the green screws on the mounting bracket.

7. Carefully insert all wires into the socket box.

8. Insert the lamp tray into the support fixed on the cable box, pass the head of M4 screw through the hole of the lamp tray, tighten the lamp, and then adjust the balance of the entire lamp body.

9. Open the crystal bag and install the crystal strings on the A.B curved metal light stand according to the picture.

10. Turn on the power to test the chandelier. Save these instructions for future use.

If the lights do not work, you can contact our customer service team to resolve the issue Maintenance mode

Clean the water with a soft dry cloth or an electrostatic duster

Avoid harsh chemicals and abrasives to clean the fixture and smooth the surface treatment.

Use safety precautions

Your light is in the water, which will damage the wiring.

After-sales questions can be contacted on the platform order page

We hope you like your new lighting as much as you like it, and if your project meets or exceeds your expectations, we would be honored if you write us a review, sharing your experience can help others and other customers understand your ideas. To your support like this we make money and we really appreciate it.

After installation, the finger mold and perspiration left on the metal and crystal surface of the lamp body can be wiped with a soft dry cloth or an electrostatic duster.