

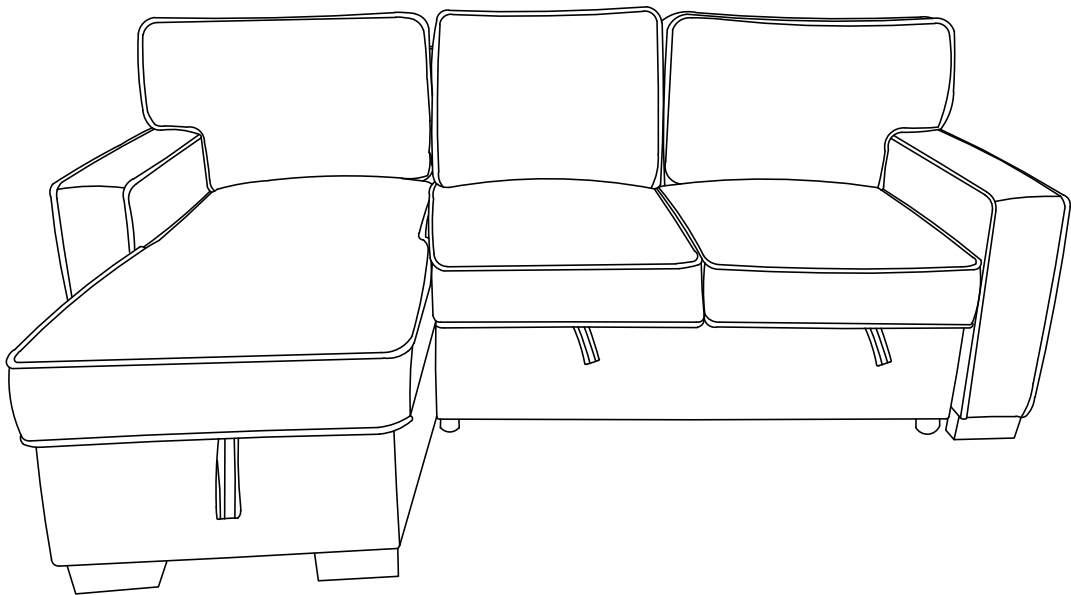





Assembly Instructions

IMPORTANT: PLACE ALL PARTS ON A CLEAN AND SMOOTH SURFACE SUCH AS A RUG OR CARPET TO AVOID THE PARTS FROM BEING SCRATCHED. PLEASE FOLLOW THE ASSEMBLY INSTRUCTIONS STEP BY STEP. DO NOT TIGHTEN ALL SCREWS UNTIL IT IS FULLY ASSEMBLED.





ASSEMBLY INSTRUCTIONS



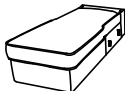

PARTS LIST

PART	DRAWING	DESCRIPTION	QTY	PART	DRAWING	DESCRIPTION	QTY
A		Love seat	1	C		RAF Back Cushion	1
B		Backrest	1	D		RIGHT Arm	1
E		Backrest	2				



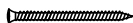

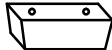



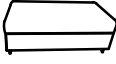

PARTS LIST

PART	DRAWING	DESCRIPTION	QTY	PART	DRAWING	DESCRIPTION	QTY
F		Chaise	1	H		LAF Back Cushion	1
				I		LEFT Arm	1

HARDWARE LIST

PART	DRAWING	DESCRIPTION	QTY	PART	DRAWING	DESCRIPTION	QTY
J		Screw M8 x 55mm	18	M		Roller	4
K		Legs	6	N		Screw #8 x 25mm	16
L		Legs	6				

packed in 3 cases

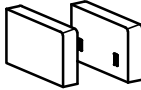
Carton	Disignation	Part	Part	Hardware
	Love seat	#A		 #Jx18pcs  #Kx6pcs  #Lx6pcs  #Mx4pcs  #Nx16pcs
	Cushion (L&R)	#C/H		
	Chaise	#F		
	Backrest	#B		
	Backrest	#E		
	Arm (L&R)	#D/I		

ASSEMBLY INSTRUCTIONS

THE PARTS ARE LOCATED INSIDE THE BOX AS BELOW:

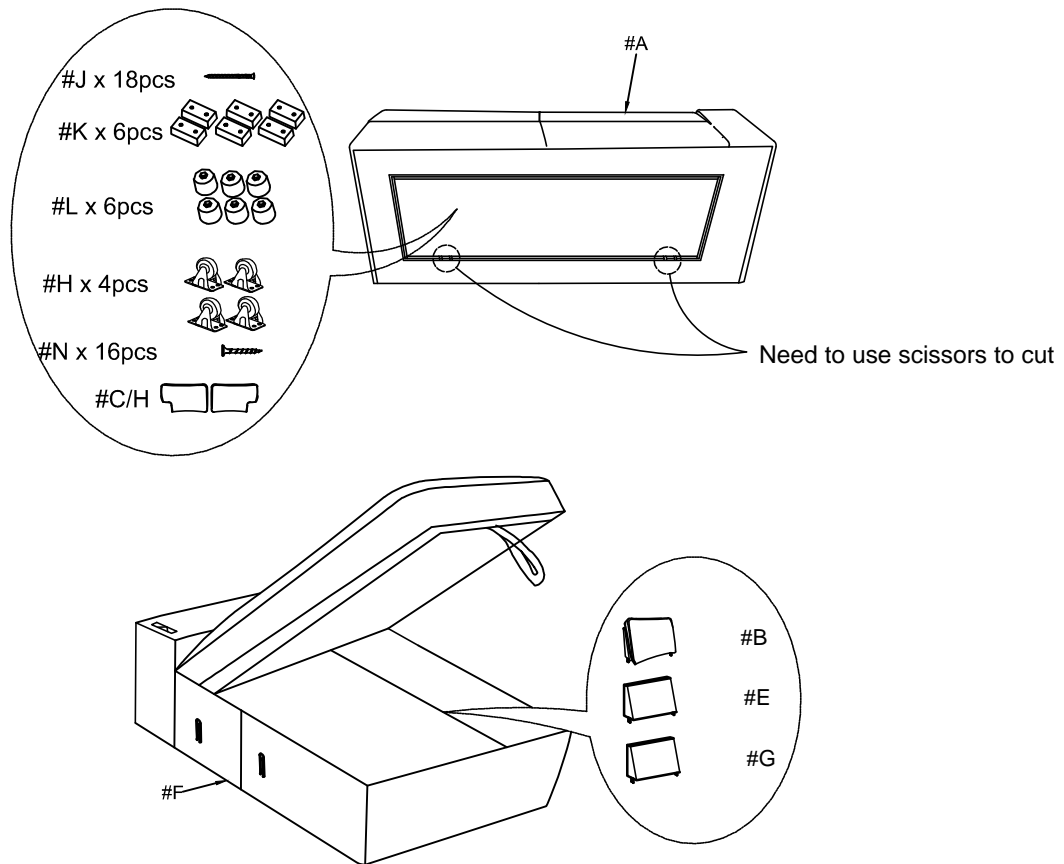

STEP 1

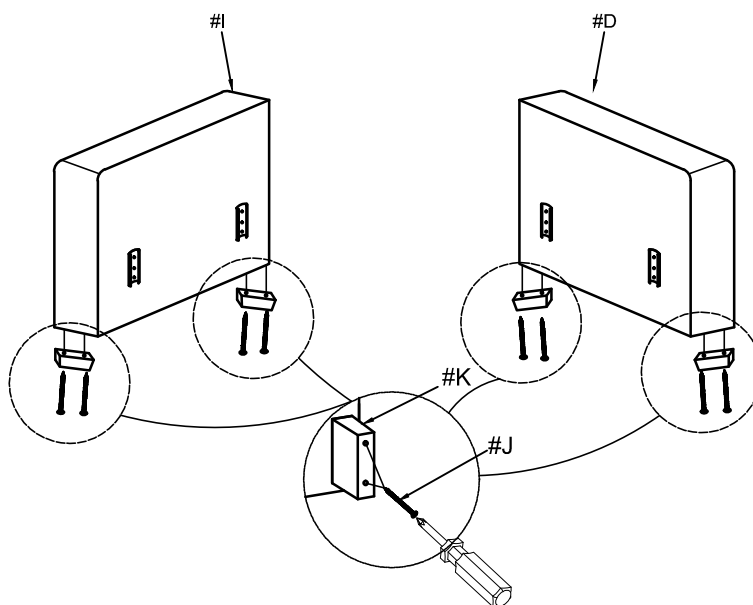

ASSEMBLY INSTRUCTIONS

STEP 2

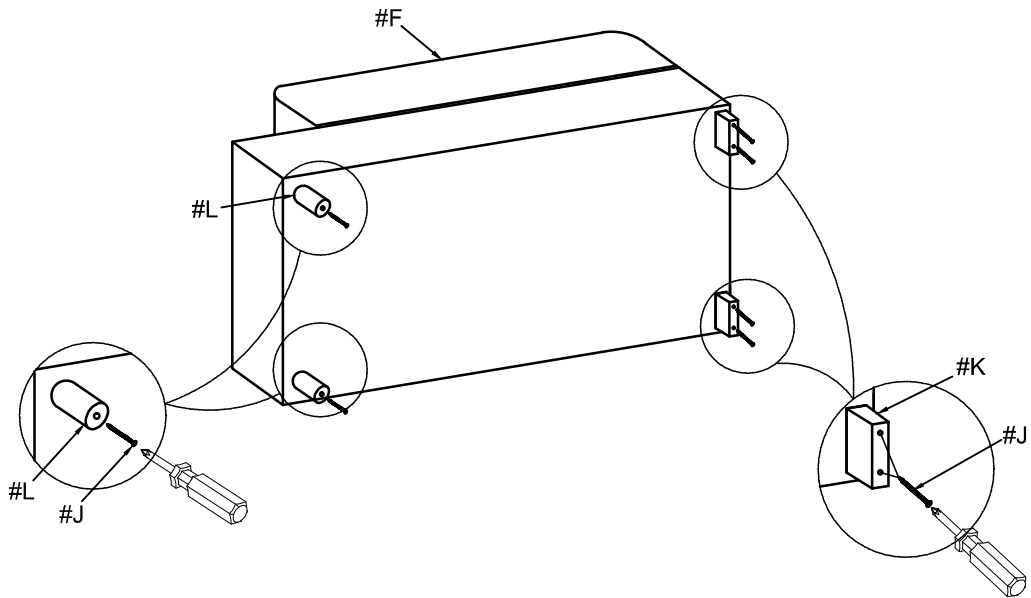

STEP 3

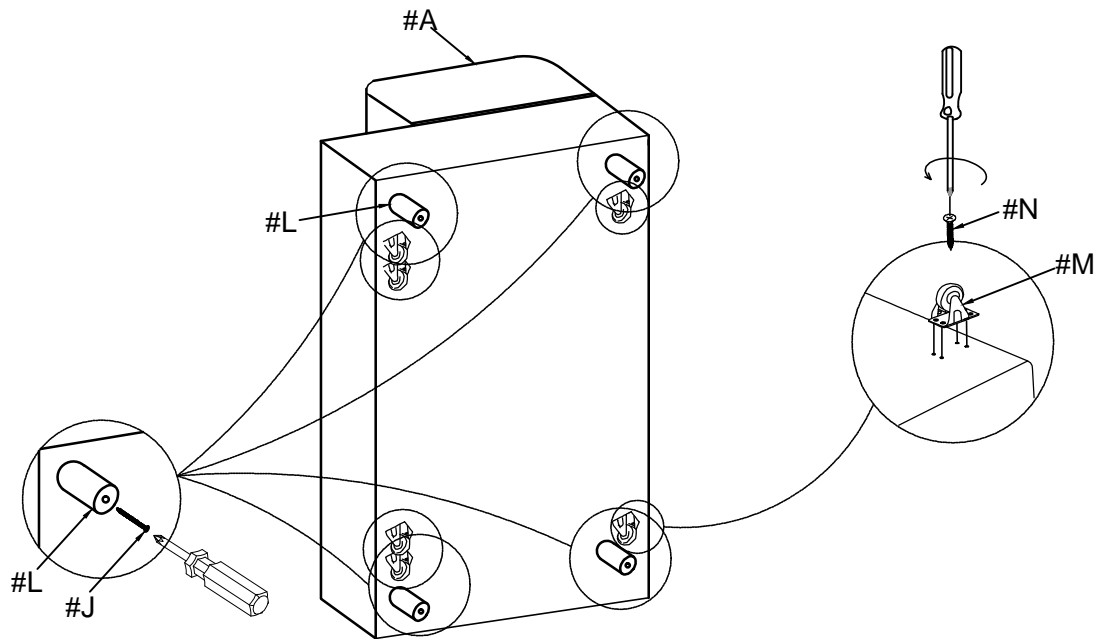

ASSEMBLY INSTRUCTIONS

STEP 4

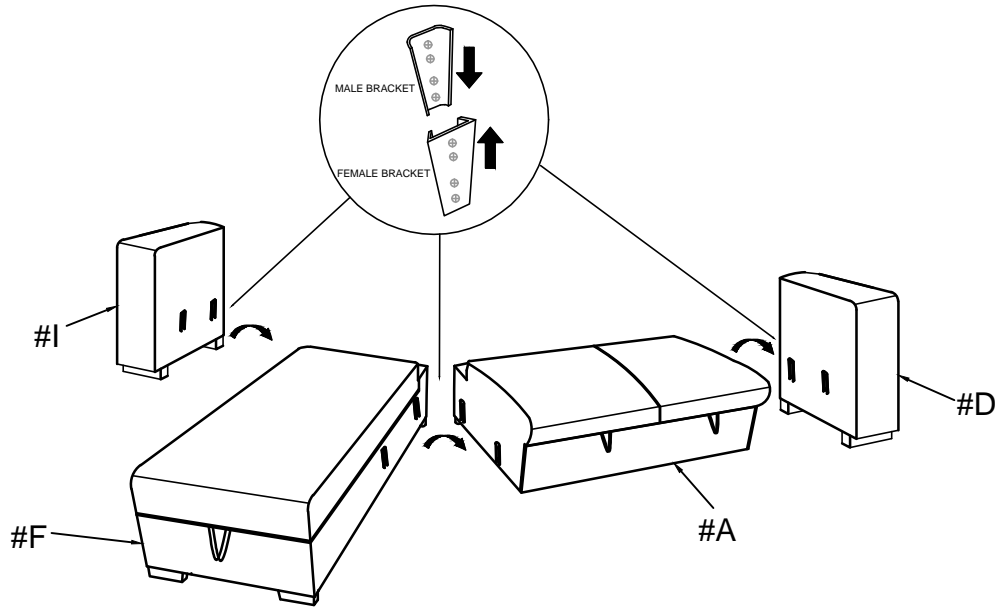

STEP 5

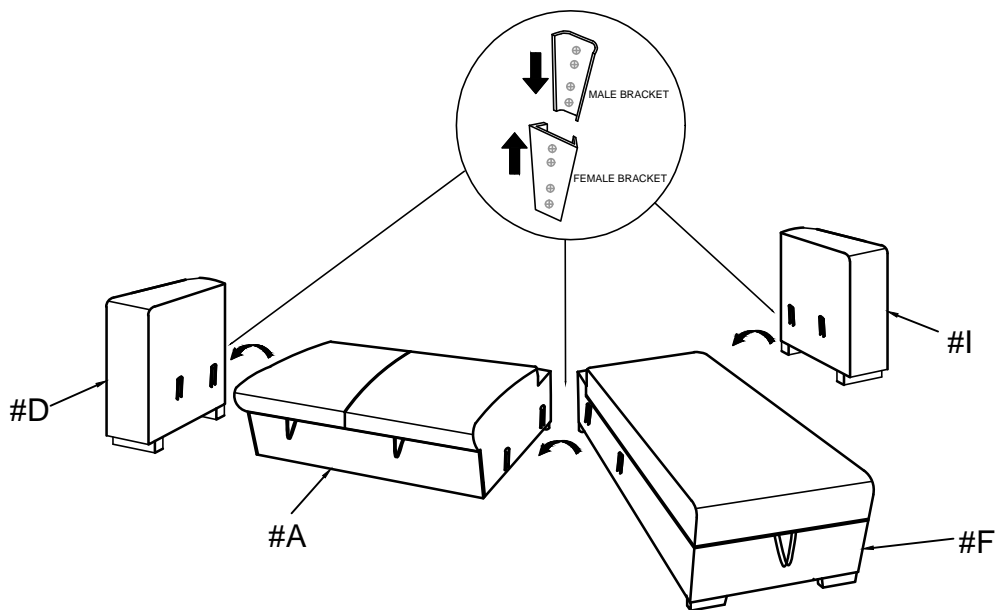

ASSEMBLY INSTRUCTIONS

STEP 6

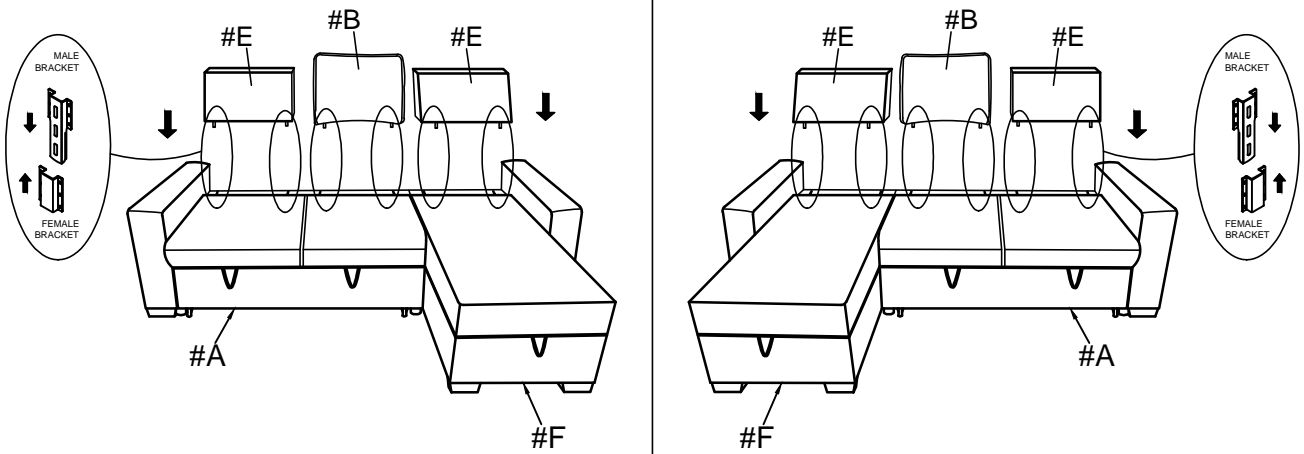

STEP 7

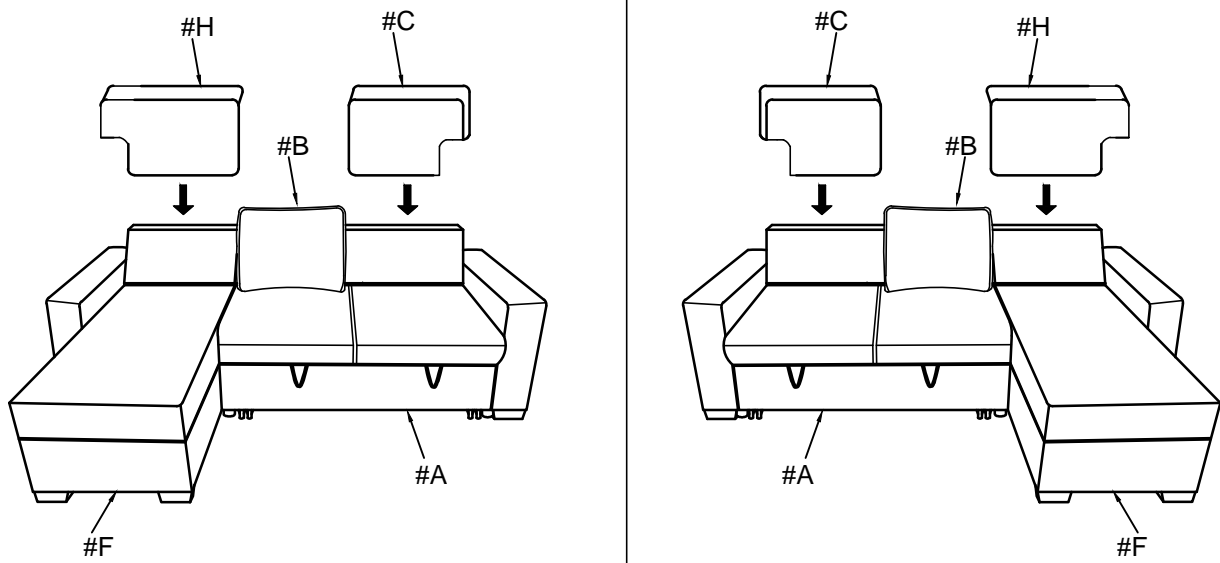

ASSEMBLY INSTRUCTIONS

STEP 8

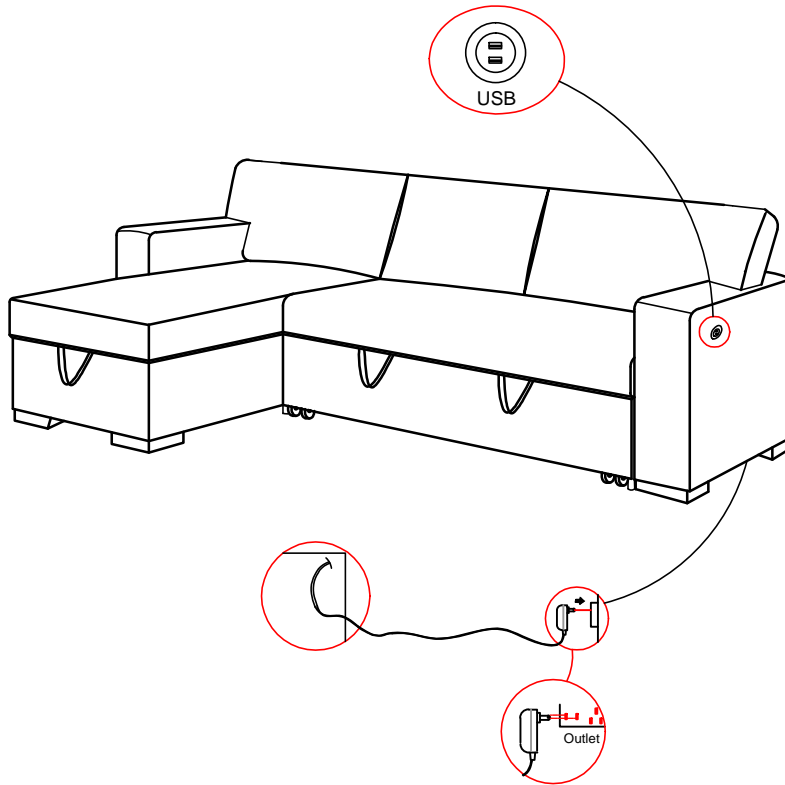

STEP 9

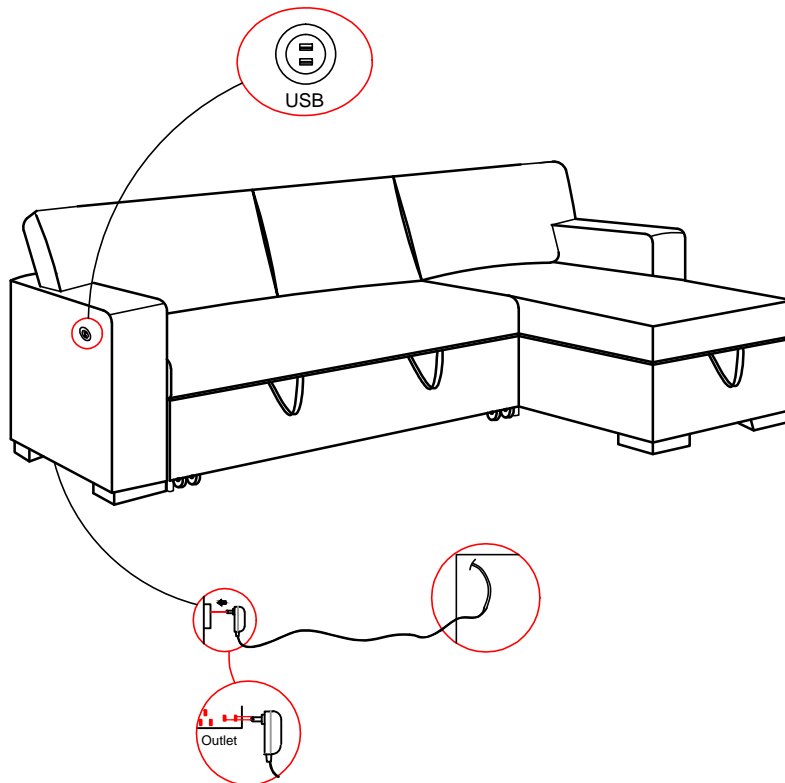

ASSEMBLY INSTRUCTIONS

STEP 10

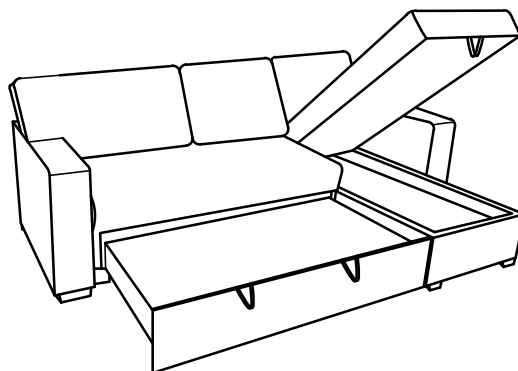
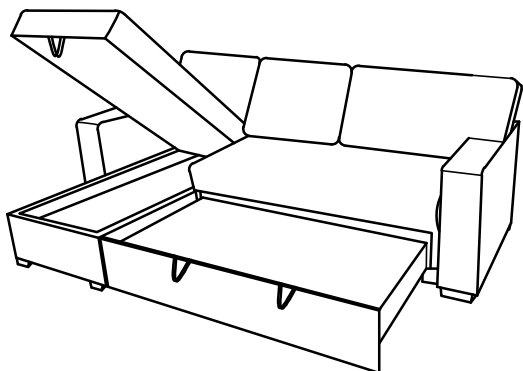

STEP 11

