

Top View

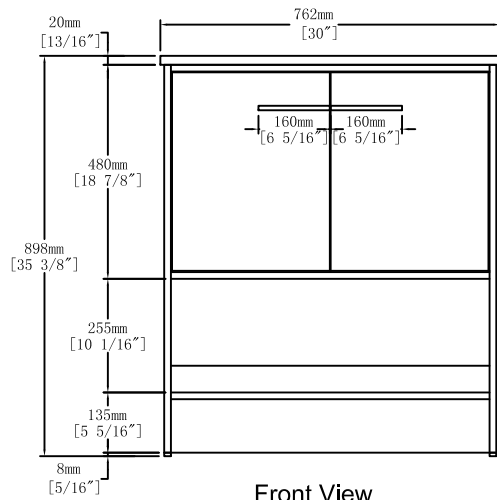

Front View

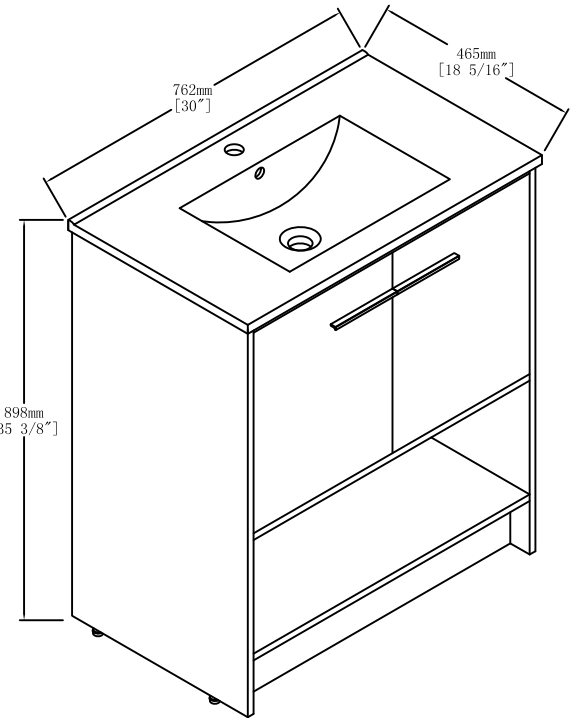
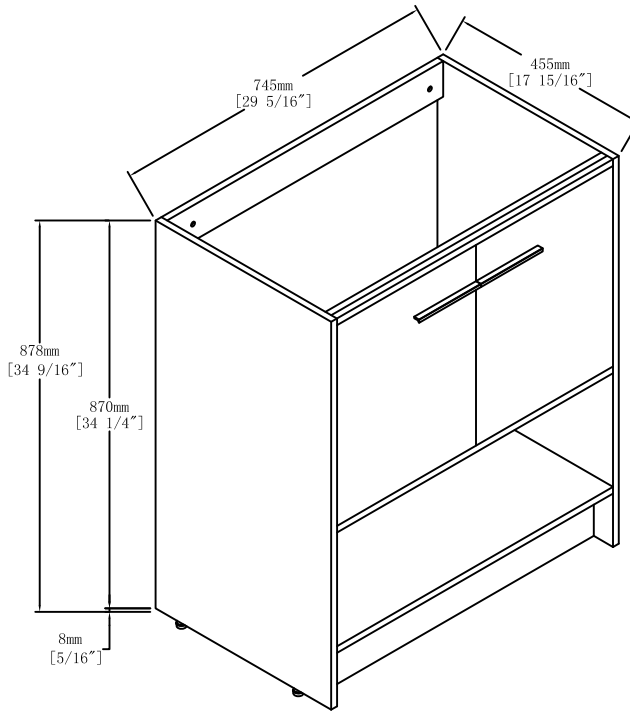
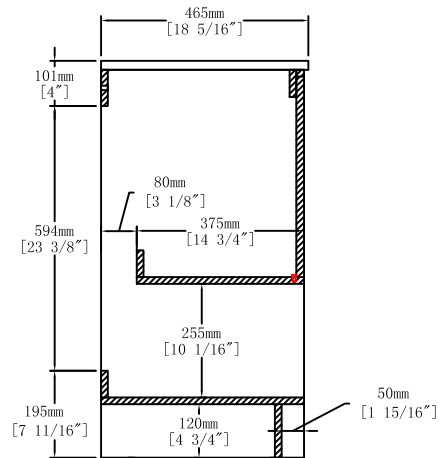

Side View



Item NO.

LV C1330

Version

V1

Project

Date

2024-4-23