

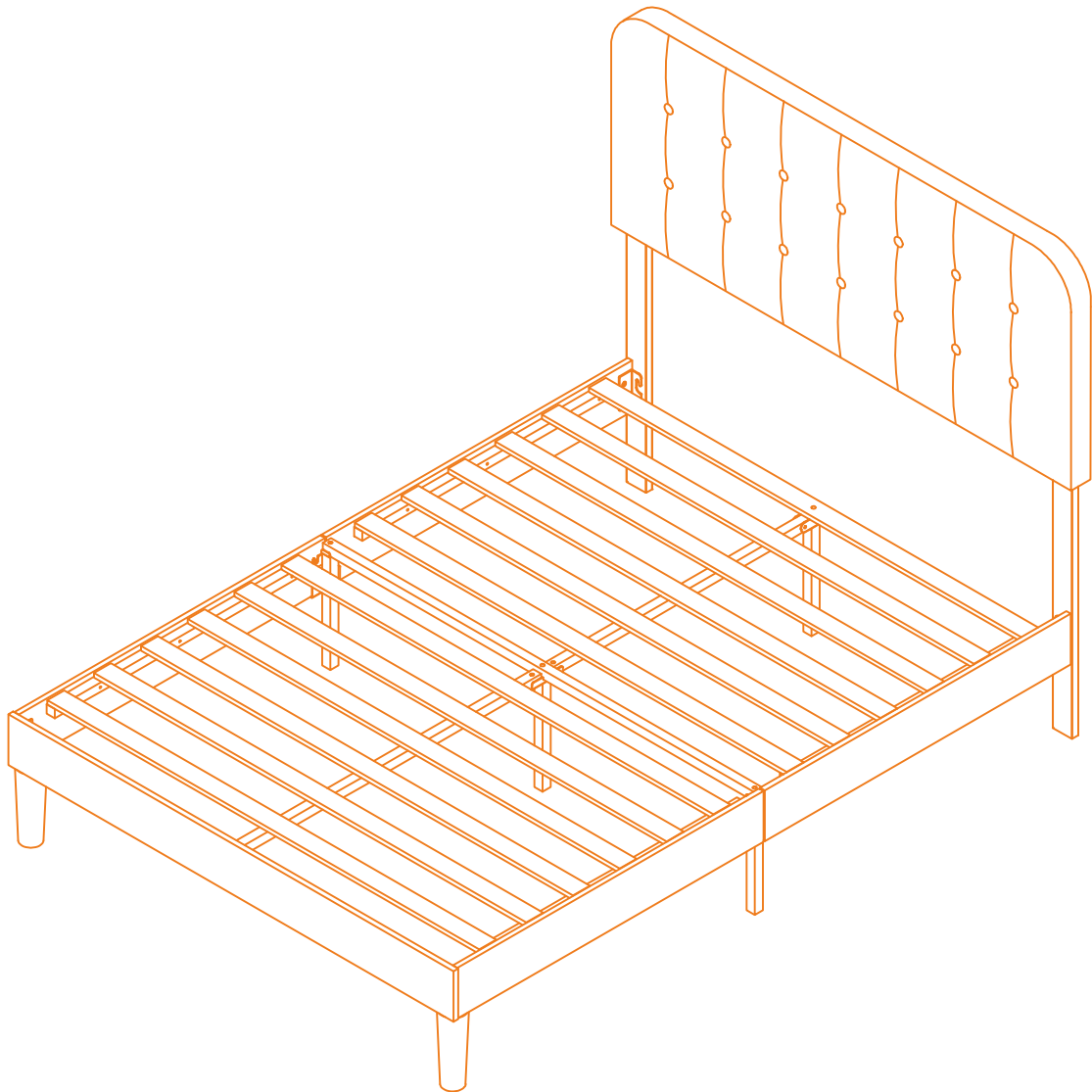

X 2

75X54 Upholstered Bed Frame



HELP CENTER

Have questions about this product? Contact us, and we'll assist you!

* Upon receiving your email, we'll respond within **48** working hours.

CENTRO DE AYUDA

¿Tienes preguntas sobre tu producto? Ponte en contacto con nosotros y te ayudaremos.

*Al recibir tu correo electrónico, te responderemos en un plazo de **48** horas laborables.

FAQ

Q1: What should I do if the product I received is damaged or incorrect?

A1: If you've received a damaged, incorrect, or incomplete product, please reach out to our Customer Support Center. Include your order number and photos

Q2: What should I do if I encounter problems during installation?

A2: If you encounter any installation issues, please email to our website, attach a detailed description of the problem, we will provide you for professional technical support.

Q3: How do I apply a return?

A3: You can initiate a return within 30 days of purchase. Email us with your order number and the reason for return. We'll guide you through the process.

Note:

- Please contact us before returning the product to avoid any complications.
- Ensure the product is returned in its original packaging with all accessories included.

PREGUNTAS FRECUENTES

P1: ¿Qué debo hacer si el producto que he recibido está dañado o es incorrecto?

R1: Si has recibido un producto dañado, incorrecto o incompleto, ponte en contacto con nuestro Centro de Atención al Cliente en. Incluye tu número de pedido y fotos que documenten el problema para que podamos ayudarte con la devolución o el cambio.

P2: ¿Qué debo hacer si encuentro problemas durante la instalación?

R2: Si tienes algún problema durante la instalación, por favor envía un correo electrónico a , adjuntando una descripción detallada del problema.

Te proporcionaremos soporte técnico profesional.

R3: Puede iniciar una devolución en los 30 días siguientes a la compra. Envíenos un correo electrónico a con su número de pedido y el motivo de la devolución.

Nota:

- Póngase en contacto con nosotros antes de devolver el producto para evitar complicaciones.
- Asegúrate de devolver el producto en su embalaje original y con todos los accesorios incluidos.

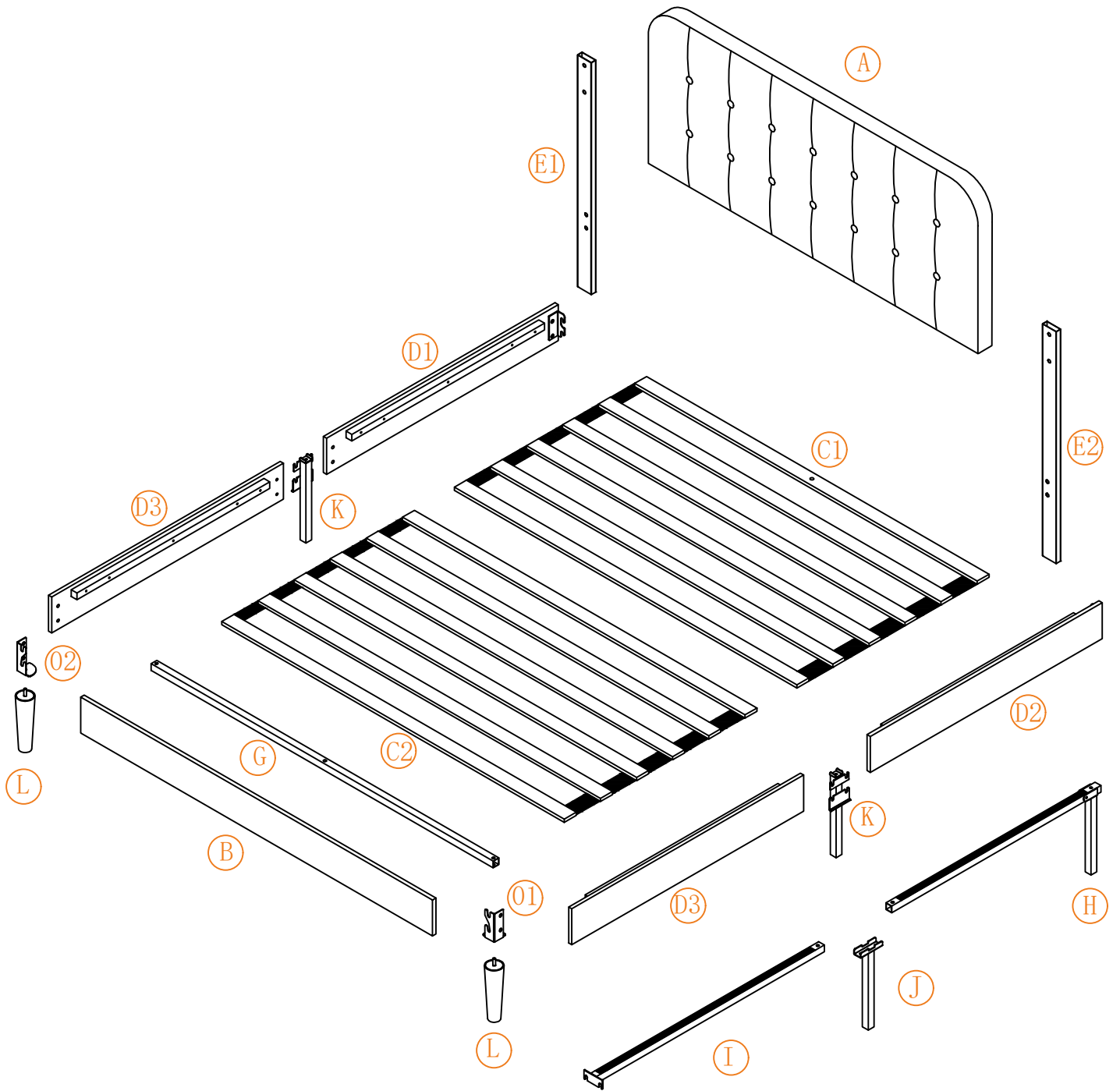

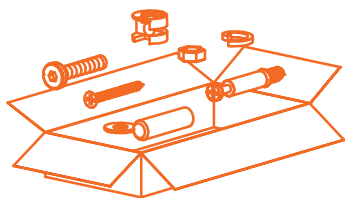

P x 2

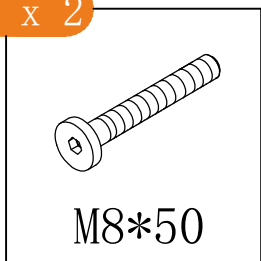

M8*50

Q x 4

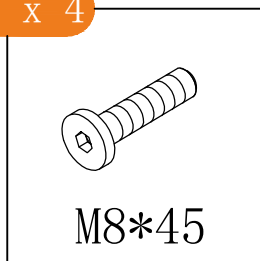

M8*45

R x 4

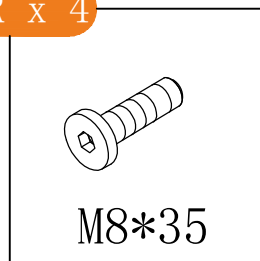

M8*35

S x 4

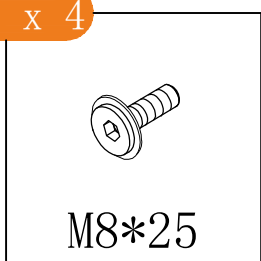

M8*25

U x 12

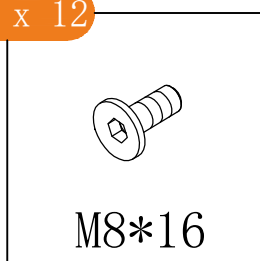

M8*16

V x 5

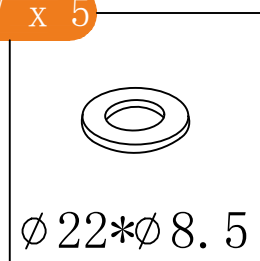

$\phi 22 * \phi 8.5$

W x 1

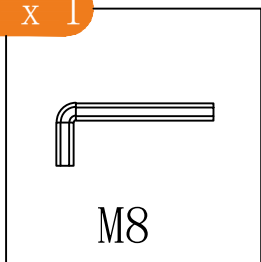

M8



(A) x1

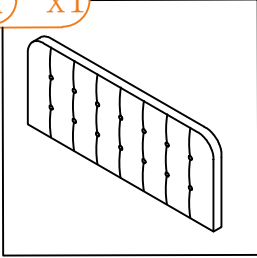

(B) x1

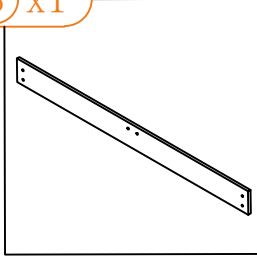

(C1) x1

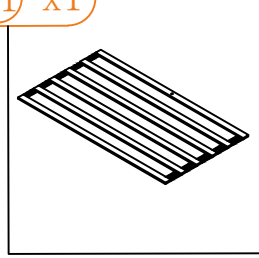

(C2) x1

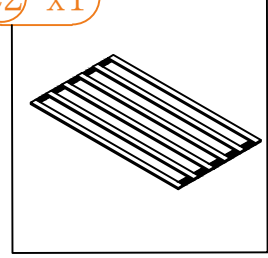

(D1) x1

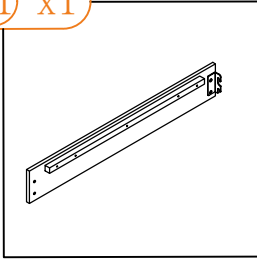

(D2) x1

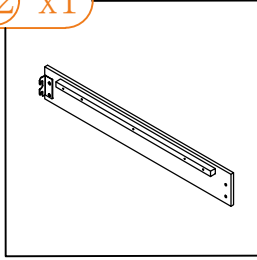

(D3) x2

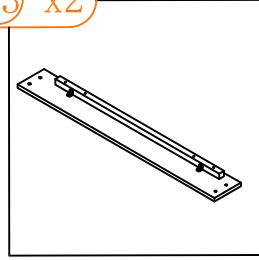

(E1) x1

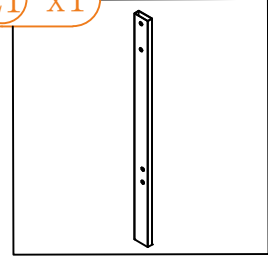

(E2) x1

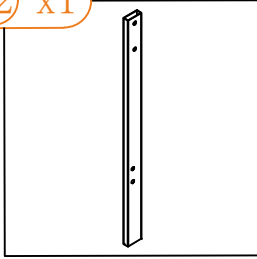

(G) x1

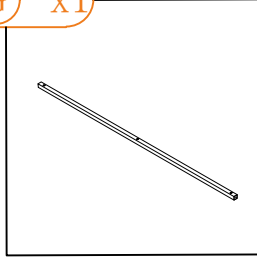

(H) x1

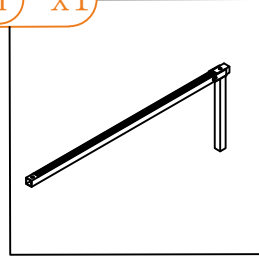

(I) x1

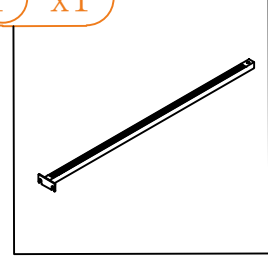

(J) x1

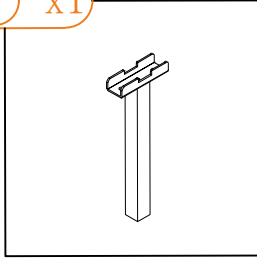

(K) x2

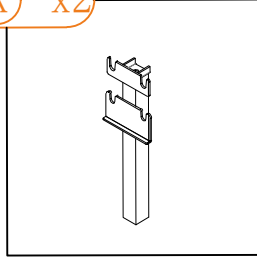

(L) x2

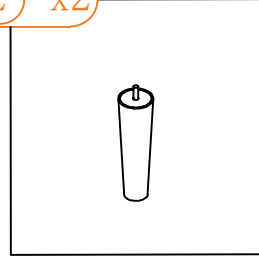

(O1) x1

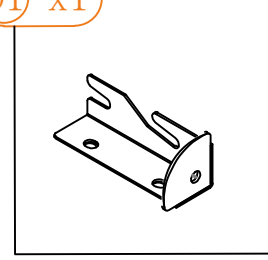

(O2) x1

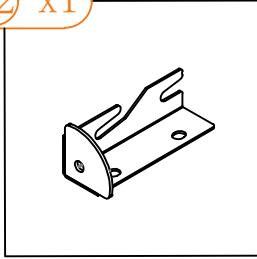

1

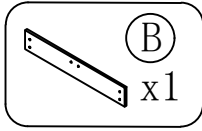

pre-installed screws.

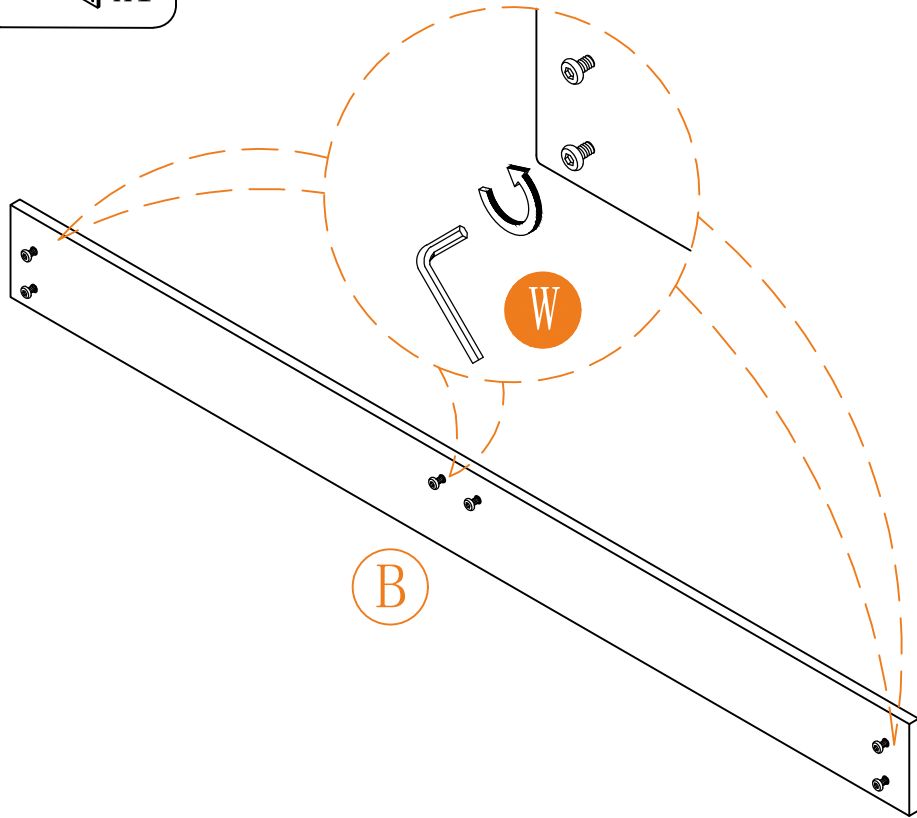

Loosen but don't remove the pre-installed screws.

2

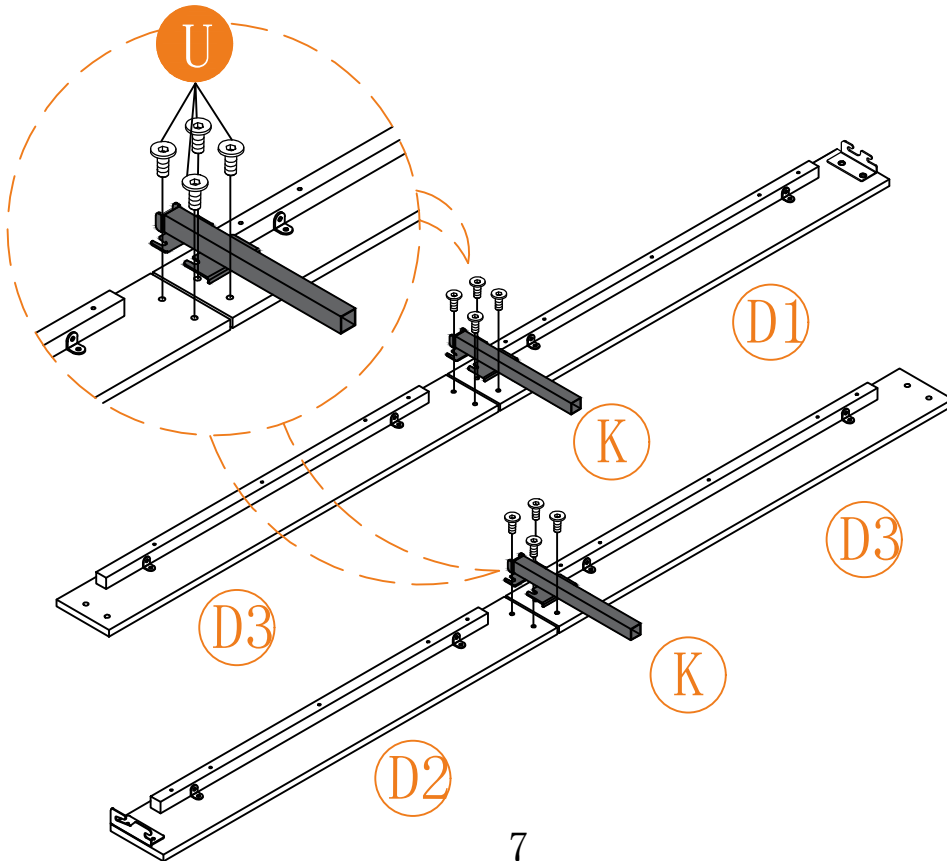
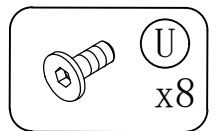
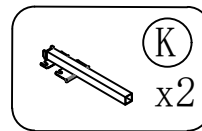
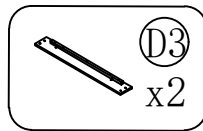
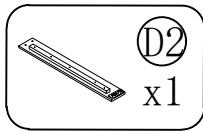
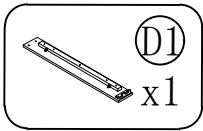

3

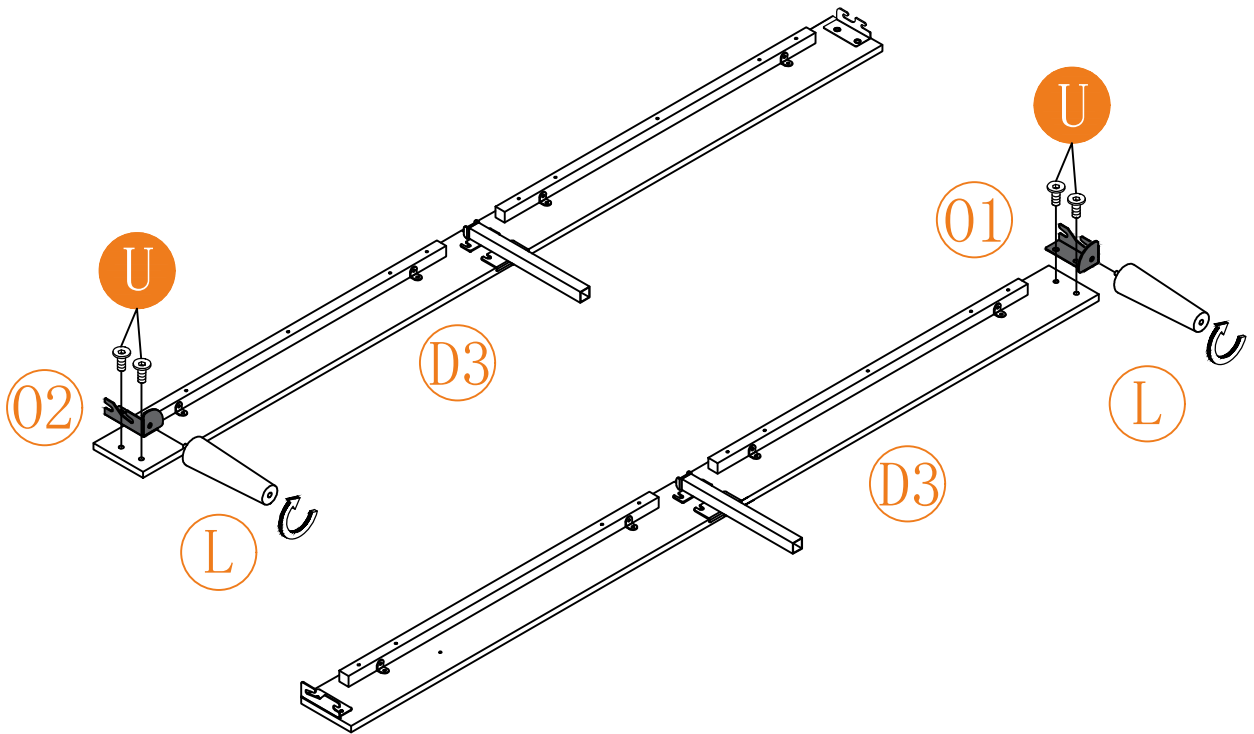
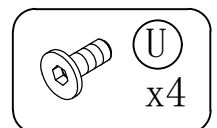
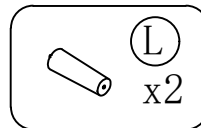
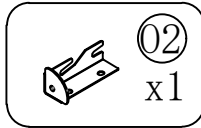
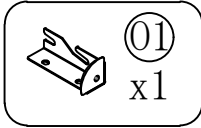

4

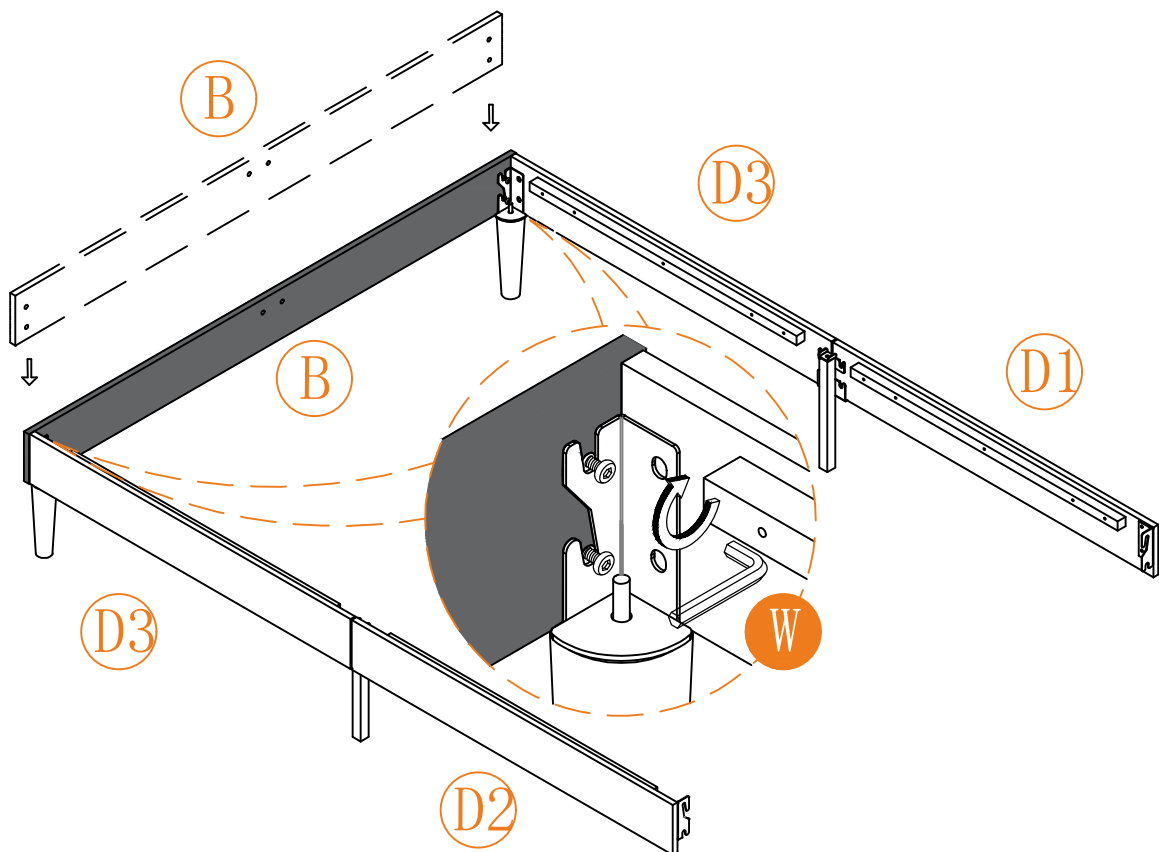

5

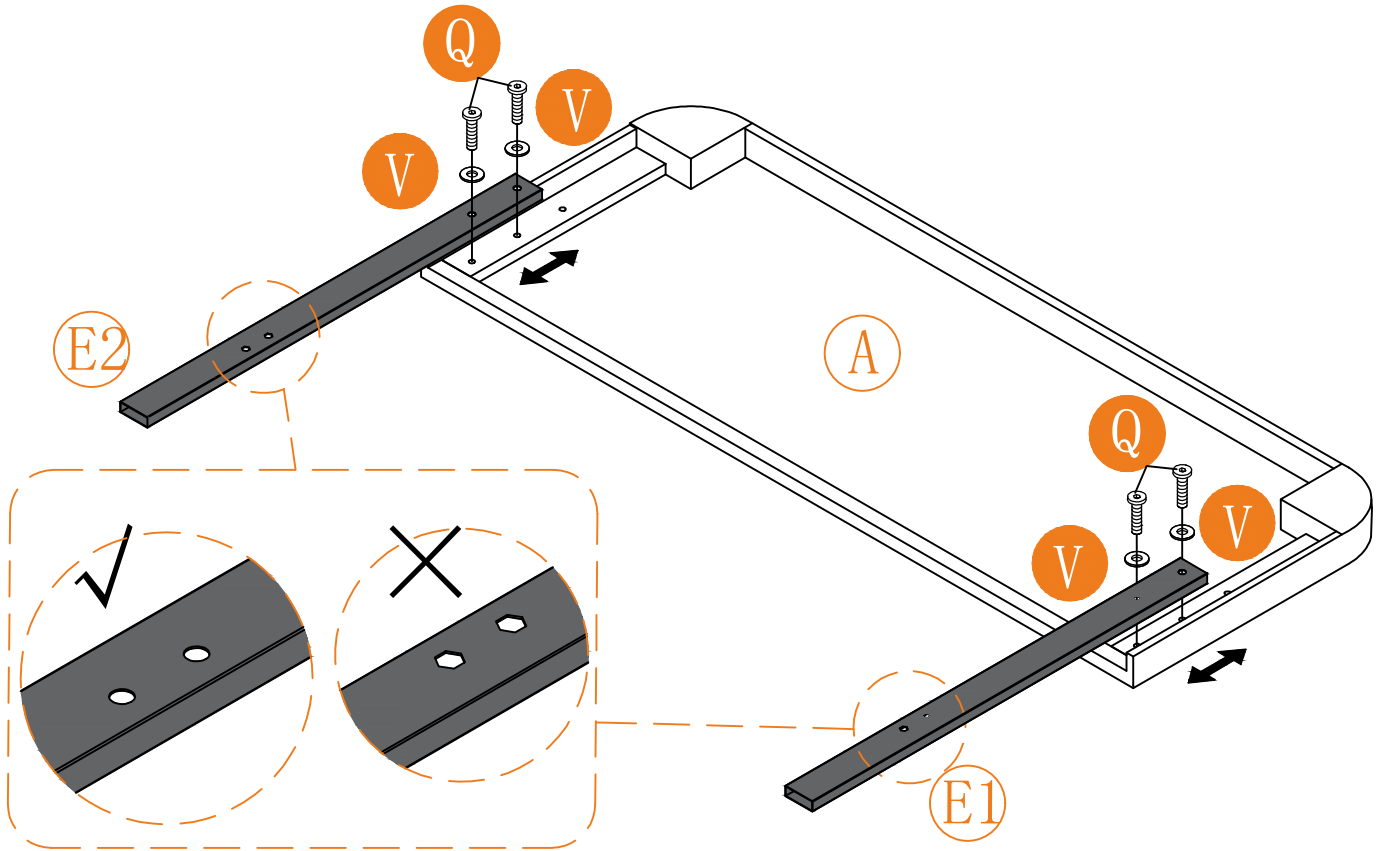
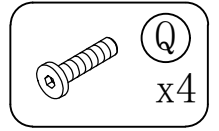
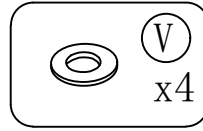
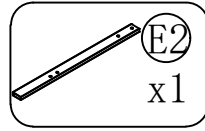
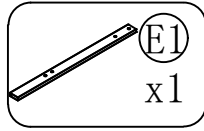
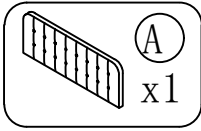

6

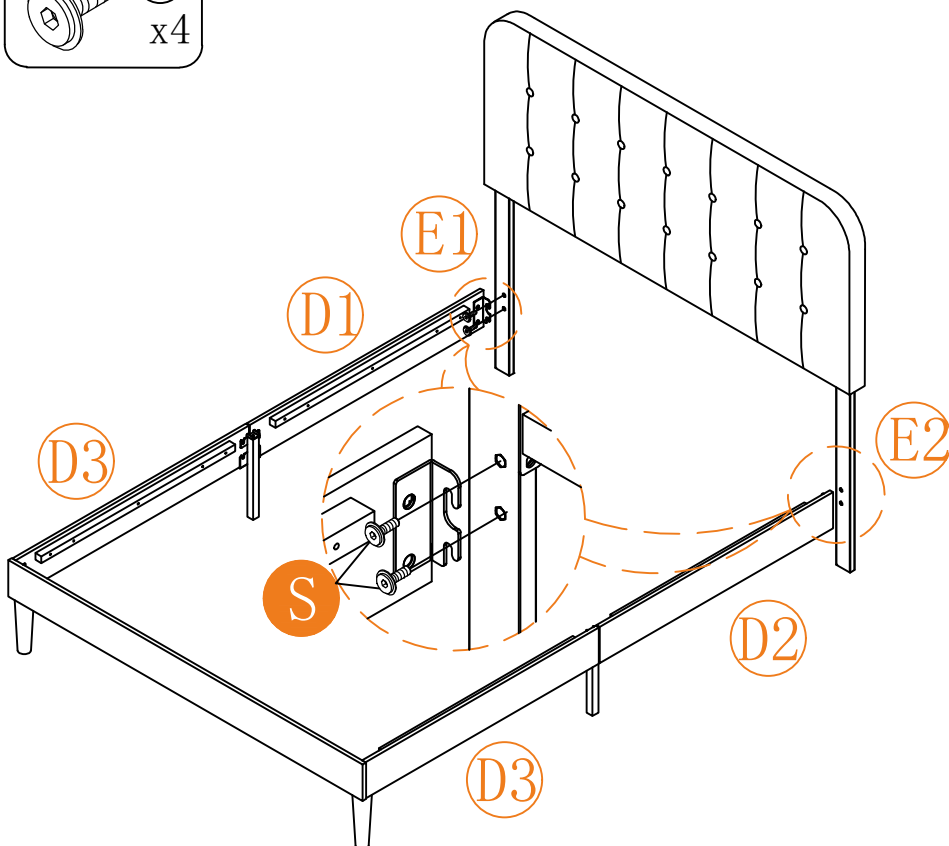
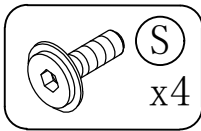

7

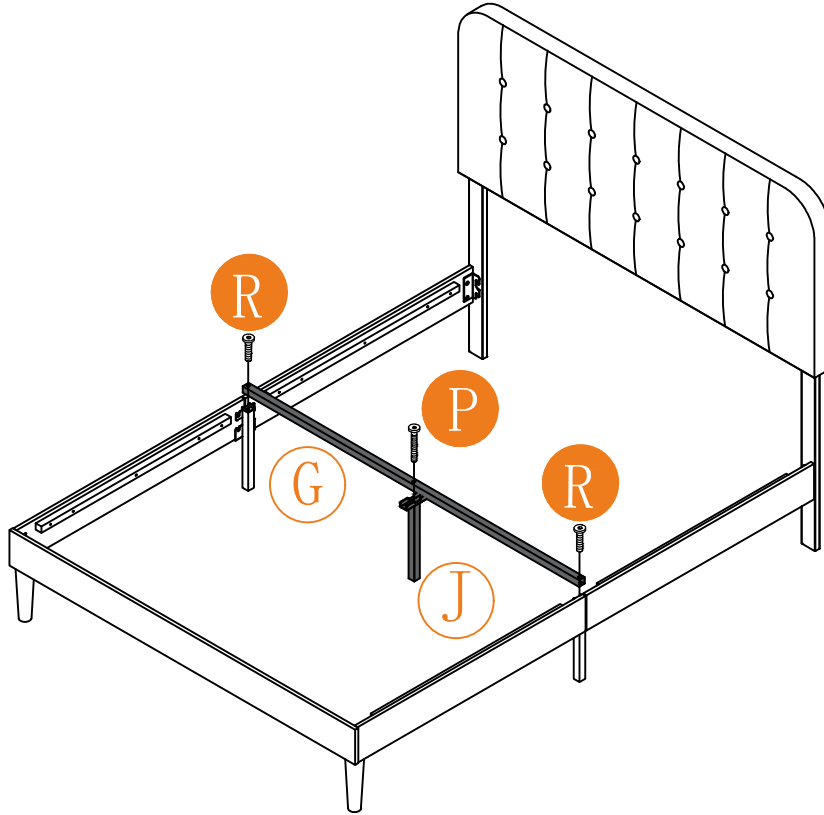
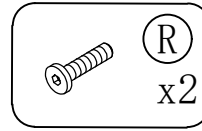
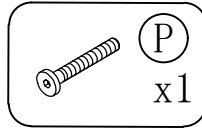
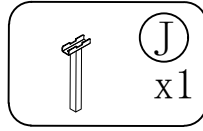
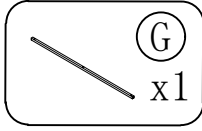

8

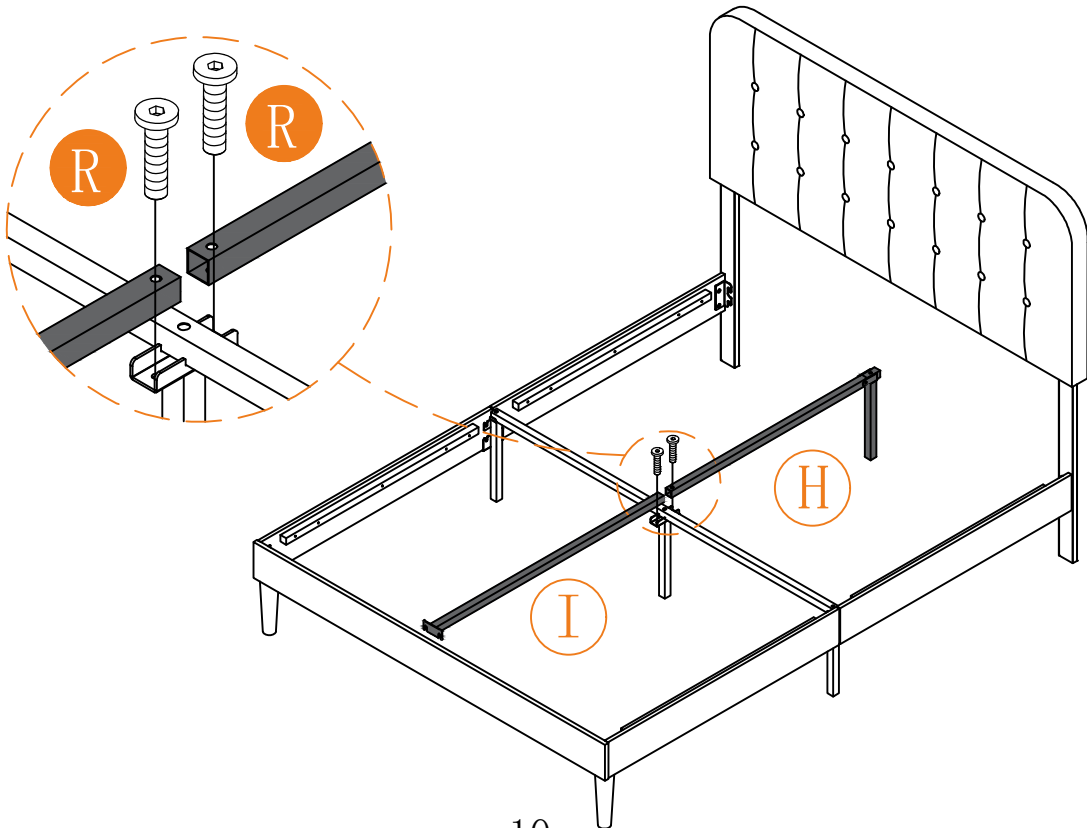
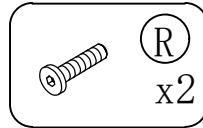
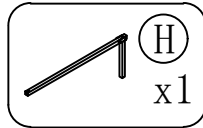
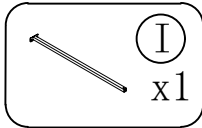

9

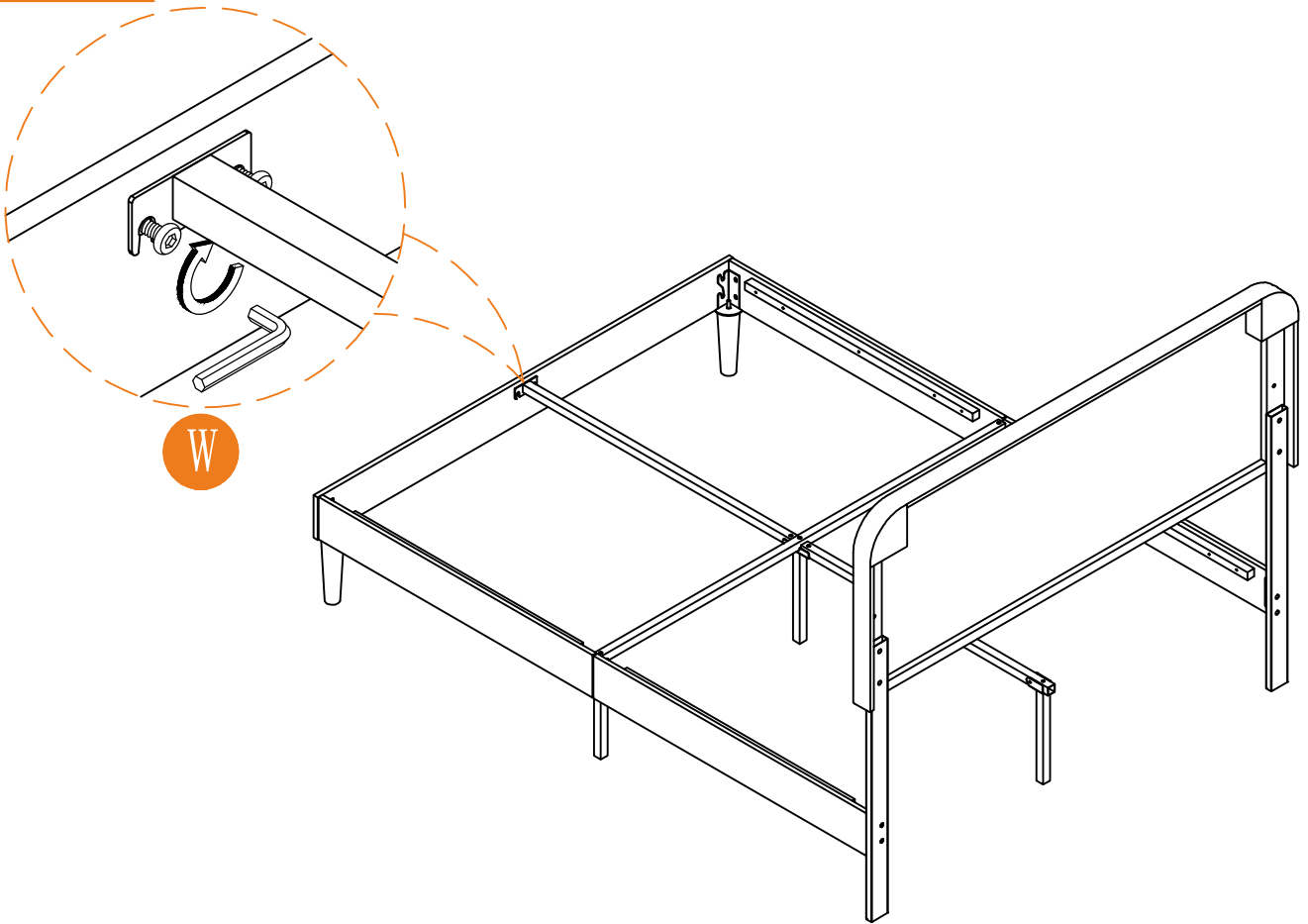

10

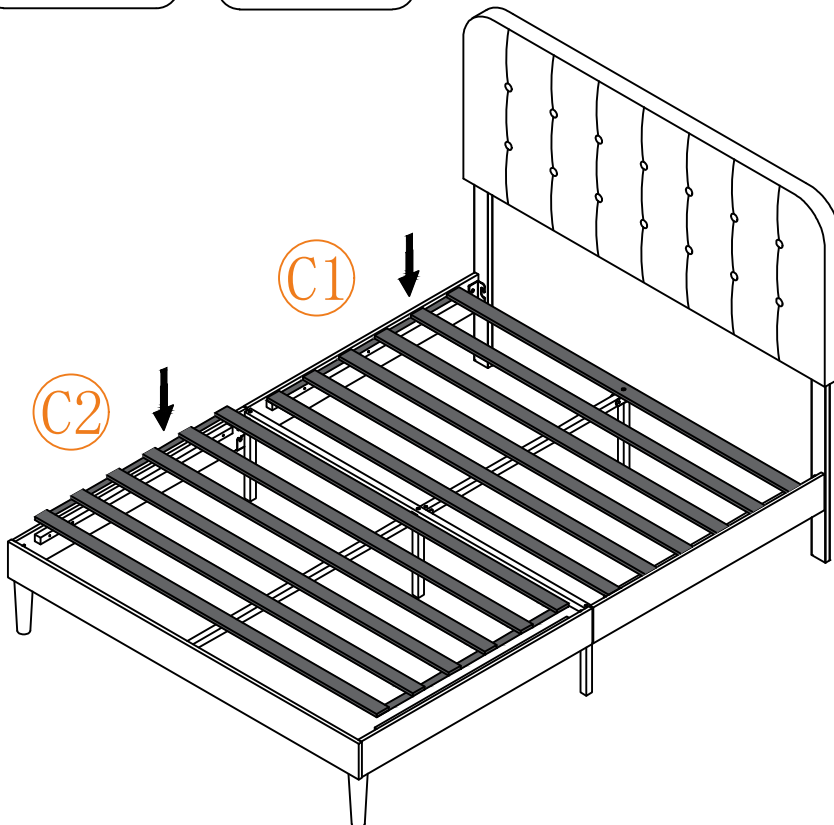
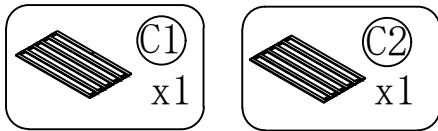

11

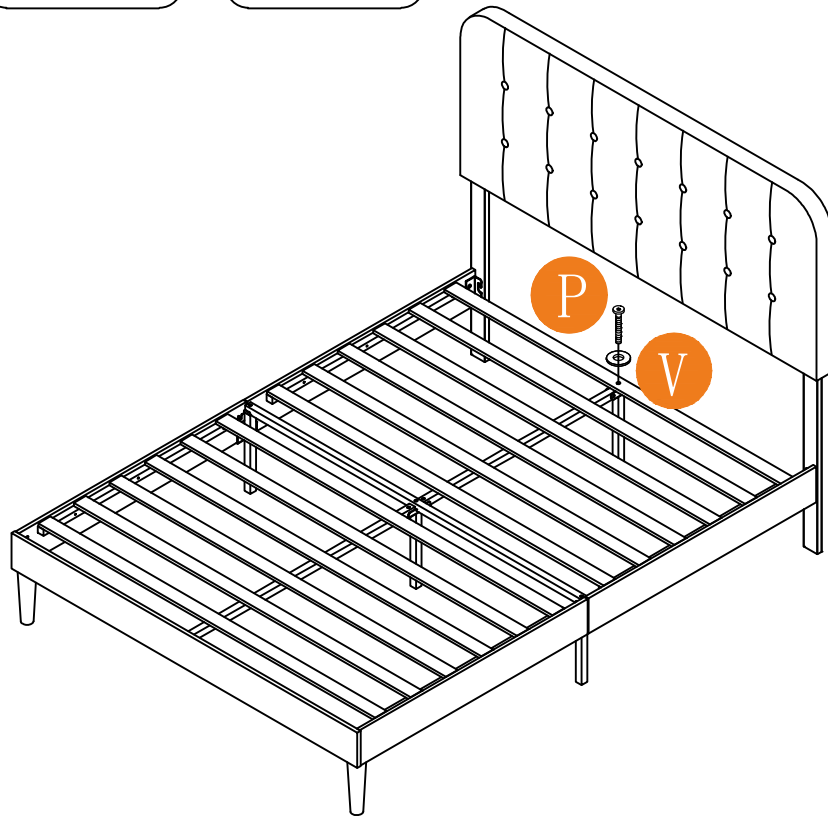
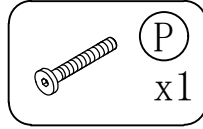
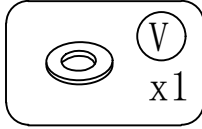

12

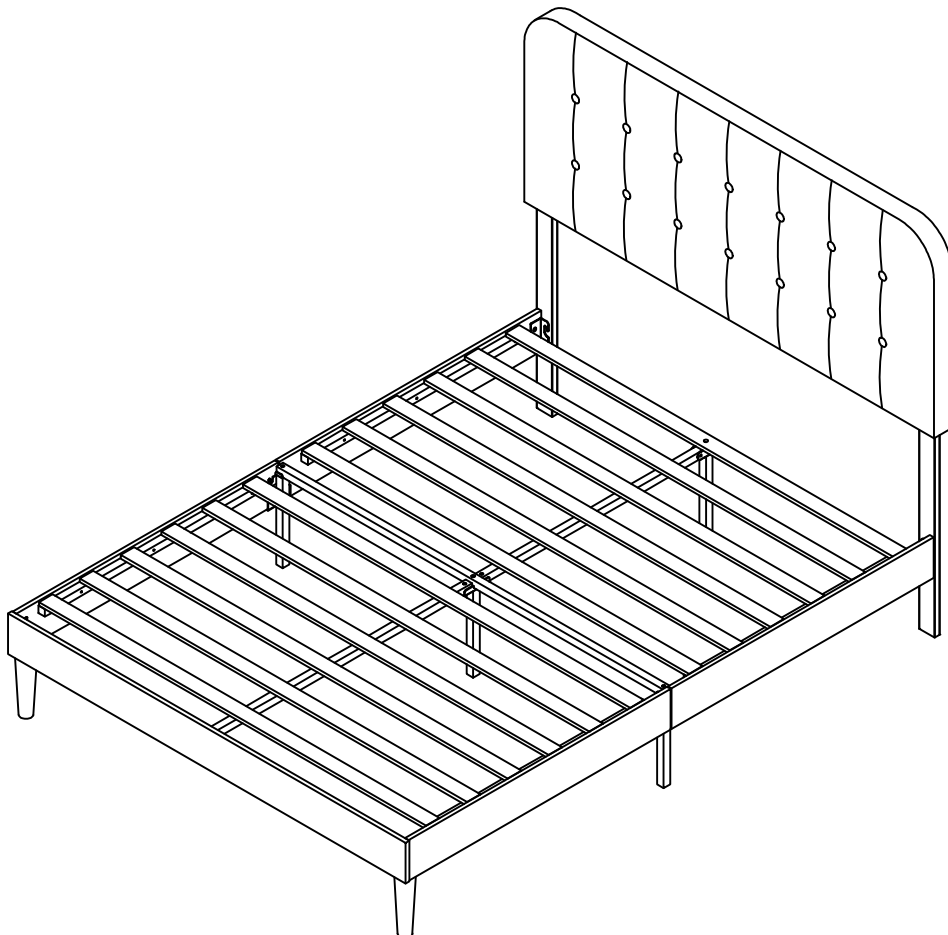

12

Tips

- This product is for indoor use only. The seller does not assume any responsibility and liability for damages caused by the following aspects:
 1. The product is used for a purpose other than its intended use and/or is changed/modified from the original one.
 2. The product is not installed/used properly under the guidelines of the instructions.
- If there are missing and/or defective part(s) after receiving the product, please stop assembling and contact us for help in time.
- Please assemble the product on a spacious place. But please do not place the unpackaged product on the ground directly, or stand/sit on the parts of this product to avoid cracking or deforming of the board. In addition, it is highly recommended that you wear gloves to avoid being cut by the edges of the product during installation.
- It is recommended that you refer to the schematic diagram to make the whole installation process easier when assembly. Align all the screws to the corresponding pre-drilled holes first, and then tighten the screws one by one after all the parts are in the correct position.
- Do not expose the product to direct sunlight or rain and/or place it in a damp place. Failure to do so may accelerate deformation, discoloration, or cause cracks. Please do not touch sharp objects or corrosive chemicals, which may damage the surface of the item.
- Please clean with a damp cloth for daily maintenance, then dry immediately.

Warnings:

- Do not intended for use by children under 3 years old. Please keep any small parts out of the reach of children during the assembly process. Children must be under adult supervision to use the product.
- Please put this product on flat ground. It is strictly prohibited to sit or stand on the product.
- It is forbidden for children to climb or play on the product to avoid serious bodily injury caused by the toppling.

Consejos

- Este producto sirve solo para uso en interiores. El vendedor no asume ninguna responsabilidad por los daños derivados de las siguientes situaciones:
 1. El producto se utiliza para un fin distinto a su uso previsto y/o se realiza algún cambio/modificación en el mismo.
 2. El producto no se instala/utiliza correctamente de acuerdo con las instrucciones.
- Si hay pieza falta o está defectuosa al recibir el producto, por favor contacta con nosotros por ayuda.
- Lleve a cabo el montaje del producto en un lugar espacioso evitando colocar el producto directamente en el suelo ni subir o sentarse en las piezas, eso puede evitar que se agriete o deformela tabla. Se recomienda usar guantes durante la instalación.
- Consulte el diagrama esquemático para facilitar el proceso de instalación durante el montaje. Alinee los tornillos con los orificios pretaladrados correspondientes y, a continuación, apriételos uno a uno cuando todas las piezas estén en la posición correcta.
- No exponga el producto a la luz solar directa o la lluvia ni lo coloque en un lugar húmedo. De lo contrario, el producto podría deformarse, decolorarse o agrietarse. No deje que el producto entre en contacto con objetos afilados o productos químicos corrosivos, ya que podría dañarse la superficie.
- Como mantenimiento diario, por favor limpie el producto con un paño húmedo y séquelo inmediatamente.

Advertencias:

Este producto no es apto para niños menores de 3 años. Mantenga las piezas pequeñas fuera del alcance de los niños durante el proceso de montaje. Los niños deben usar el producto bajo la supervisión de los adultos.

- Coloque el producto sobre una superficie plana. No permita que nadie se suba o se sienta en el producto
No permita que los niños se suban o jueguen sobre el producto para evitar lesiones corporales graves causadas por caídas.