







# Installation

## STEP 1

N <sup>o</sup> .	Parts	Quantity
①		1
②		2
③		1
④		1

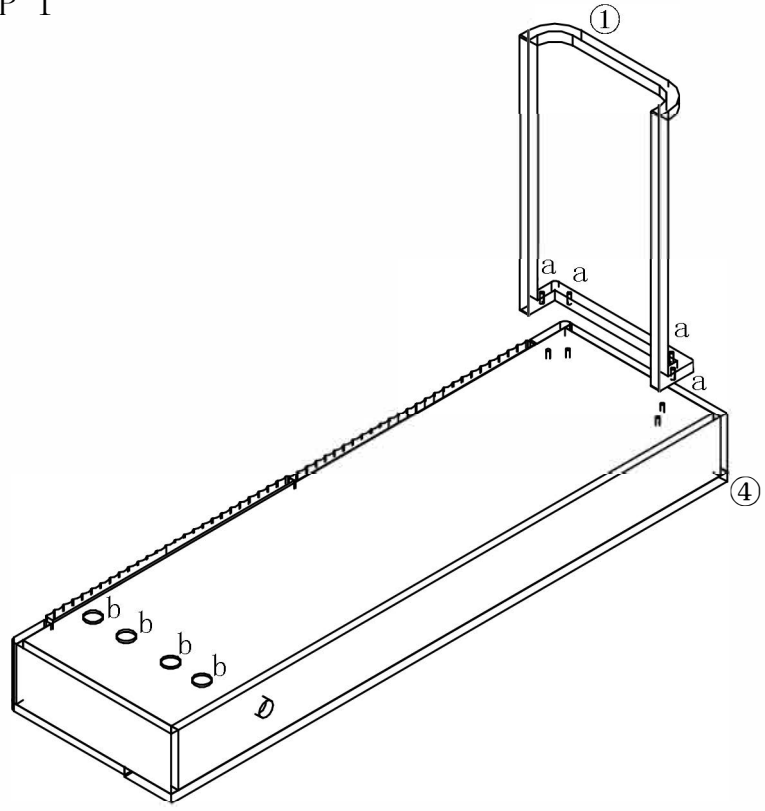

## STEP 2

N <sup>o</sup> .	Parts	Quantity
a		M6*35=4
b		4

